



# User Manual

## CANline 02

### Alarm and Control system



Copyright © 2015 by KIMESSA –Switzerland

All rights are reserved by KIMESSA. Any reproduction, whether in hard or digital copy, even in part, without written permission of KIMESSA-Swiss in any design and shape is prohibited.

The information in the documents are created according to current knowledge. Due to ongoing product developments, technical changes or deviations may occur.

KIMESSA AG  
Rautistrasse 12  
CH-8047 Zurich / Switzerland

Tel.: +41 (0)44 404 38 38  
Fax: +41 (0)44 404 38 39  
Email [info@kimessa.com](mailto:info@kimessa.com)  
Home [www.kimessa.com](http://www.kimessa.com)

# Contents

<b>1</b>	<b>GENERAL INFORMATION .....</b>	<b>4</b>
1.1	LIMITATION OF LIABILITY .....	4
1.2	RETENTION OF TITLE.....	4
1.3	WARNING.....	4
1.4	WARRANTY .....	5
1.5	CONDITIONS FOR STORAGE AND TRANSPORT .....	5
1.6	DISPOSAL OF THE PRODUCT .....	5
1.7	IMPORTANCE OF INSTRUCTIONS.....	5
1.8	RISK / POTENTIAL HAZARD .....	6
1.9	SAFETY / RESPONSIBILITY.....	6
1.10	IF EX-MEASURING SENSORS ARE CONNECTED IN HAZARDOUS AREAS THE FOLLOWING MUST BE OBSERVED:.....	6
1.11	DEFINITION OF THE SIGNAL WORDS .....	8
1.12	TARGET GROUP, ELECTRICIANS AND MAINTENANCE TECHNICIANS; PERSONAL PROTECTIVE EQUIPMENT .....	8
<b>2</b>	<b>USAGE.....</b>	<b>11</b>
2.1	INTRODUCTION.....	11
<b>3</b>	<b>CANLINE 02 CONSTRUCTION .....</b>	<b>12</b>
<b>4</b>	<b>INSTALLATION .....</b>	<b>13</b>
4.1	CONDITIONS OF USE/INSTALLATION/WHERE AND HOW WILL THE CONTROL UNIT BE MOUNTED? .....	13
4.2	MECHANICAL INSTALLATION OF CANLINE 02 .....	14
4.3	DELIVERY CONTENTS, CANLINE 02 GAS DETECTION CONTROL UNIT .....	15
4.4	CANLINE/ OPENING/ CLOSING THE CONTROL UNIT .....	15
4.5	INSTALLATION MEASUREMENTS.....	15
4.6	ELECTRICAL INSTALLATION/ CONNECTING THE CONTROL UNIT .....	16
4.7	T2 AMP FUSES.....	16
4.8	POWER SUPPLY .....	16
4.9	SENSOR-CABLE BUS-INSTALLATION .....	16
4.10	KIMESSA-CABLE .....	17
4.11	ELECTRICAL INSTALLATION/ EMC AND ATEX .....	18
<b>5</b>	<b>CANLINE 02 CONNECTIONS.....</b>	<b>21</b>
5.1	WIRING SCHEMATIC FOR 2 X 4..20MA DETECTORS .....	22
5.2	WIRING SCHEMATIC FOR 2 X DIGITAL BUS DETECTORS.....	22
5.3	WIRING SCHEMATIC FOR REALY CONTACTST (STANDARD).....	24
<b>6</b>	<b>USER COMFORT .....</b>	<b>25</b>
6.1	FRONT VIEW, DIMENSIONS AND CONTROL ELEMENTS.....	25
6.2	FRONT FUNCTIONS.....	25
6.3	ALARM RESET .....	26
6.4	"SWITCH TO INACTIVE" BUTTON FUNCTION, ONE SENSOR .....	26
6.5	" SWITCH TO INACTIVE " BUTTON FUNCTION, SEVERAL SENSORS .....	26

<b>7</b>	<b>SWITCHING ON</b> .....	<b>27</b>
<b>8</b>	<b>MAIN MENU</b> .....	<b>28</b>
8.1	NORMAL OPERATION / SENSOR DISPLAY .....	29
8.2	FIRST STEPS TO THE MENU .....	29
8.3	SYSTEM INFO MENU .....	30
8.4	NEXT SERVICE - SYSTEM INFO - .....	30
8.5	QUANTITY OF SENSORS - SYSTEM INFO.....	31
8.6	FIRMWARE VERSION - SYSTEM INFO.....	31
8.7	DC VOLTAGE INFO - SYSTEM POWER.....	32
8.8	POWER DC CURRENT - SYSTEM INFO.....	32
8.9	ALARM HISTORY 1 ... 10 - SENSOR 3 ALARM - HISTORY 2 - SYSTEM INFO.....	33
8.10	RELAY CHECK 1 ... 5 / MENU STRUCTURE / SYSTEM INFO.....	34
8.11	EXIT TO MAIN MENU .....	35
8.12	EXIT TO "NORMAL OPERATION" .....	36
8.13	"NORMAL OPERATION" VIA "EXIT" IN THE MAIN MENU.....	36
<b>9</b>	<b>DECLARATION OF CONFORMITY</b> .....	<b>37</b>

# 1 General Information

## 1.1 Limitation of Liability

Prior to installation and use of KIMESSA products please review the entire manual Carefully read, understand and observe. KIMESSA assumes no liability for damages arising due to misapplication, installation, storage, maintenance or non-observance of instructions and those which may arise due to local rules and regulations. This applies both for property and for personal injury of any kind.

KIMESSA disclaims any liability for any advice and execution errors by personnel which are not permanent employees of KIMESSA. Even if the dealer is acting on behalf of the company, they shall be liable for their own actions.

KIMESSA assumes no liability for direct or indirect damages, whether to property or persons, which are direct or indirect damages through the use of the products.

KIMESSA points out that they are gas detectors for protection of property and persons. Usage in adjacent areas such as measurement technology or process technology shall be at the user's own risk.

## 1.2 Retention of title

All information, technical specifications, drawings and images in this manual are confidential information owned by KIMESSA.

This material may not be distributed, copied in any form, even in part, or be disclosed to third parties without the written consent of KIMESSA. This includes all currently known and future techniques for reproduction and distribution of documents in written, image, voice or translation form.

## 1.3 Warning

KIMESSA's products are focussed on gas detection technology used in the field of safety and sensor technology. The products are used for protecting people and areas from gas hazards.

An appropriately qualified and equipped design based on the applicable country-specific regulations is mandatory here and must be observed.

Commissioning and regular maintenance according to the operating instructions and the applicable land specific regulations is essential and a precondition for the warranty.

Without regular maintenance, the functionality of products cannot be ensured. Due to the numerous possibilities of error, maintenance must be carried out by skilled personnel authorized by KIMESSA.

## 1.4 Warranty

KIMESSA AG guarantees the quality of all its products. It grants a guarantee on the material, under normal use and regular maintenance, for 12 months from the date of purchase. A later commissioning of the products does not extend the guarantee period, since for example sensors age due to storage conditions. KIMESSA shall repair or replace free of charge any part which proves to be defective within the warranty period. Excluded from any warranty and free repair are wear-resistant parts of any kind, such as sensors, batteries, etc. KIMESSA reserves the right to decide during the warranty period whether a repair is carried out using new parts or equivalent used parts. Furthermore KIMESSA shall decide whether a repair or replacement of the affected parts shall occur. In case of exchange of the product, equivalent used parts can also be used.

A warranty case neither extends the warranty nor does it newly initiate it.

The warranty only covers the products and components delivered by KIMESSA. All Incremental costs for labour, directions, accessibility, etc. are not covered by the warranty.

Any (old) parts replaced within and on warranty are the property of KIMESSA and must be handed over or sent free of charge.

KIMESSA reserves the right, after successful examination, to bill any additional cost incurred due to defects not covered under warranty.

Special contracts, agreements or country-specific Conditions of Use can be used as deviations or extensions for this purpose.

## 1.5 Conditions for storage and transport

To prevent damage, the following points should be noted:

- No heavy mechanical stress like throwing, suspension, stacking
- No environment where moisture or rain may cause damage
- Do not expose to direct sunlight for an extended period
- The storage temperature must not be less than -25°C and higher than +65°C

## 1.6 Disposal of the product



Only European Union (and EEA). This mark indicates compliance with the EU Directive (2002/96/EC). This product should therefore not be disposed of along with normal household waste.

It must be deposited at an official drop off point for disposal of electrical and electronic devices which is a designated collection point for this purpose or returned in exchange for an equivalent new device from an authorized dealer.

## 1.7 Importance of Instructions

This guide aims to provide for safe and proper handling of KIMESSA gas detection systems and KIMESSA transmitters, especially for planners and contractors, as installers, maintenance personnel and operators.

## 1.8 Risk / Potential hazard

KIMESSA gas detection systems and transmitters pose no risks subject to a proper and appropriate use of our systems and components, these represent no hazard. A threat of non-execution or false alarm is only given when untrained and unauthorized personnel operate the gas detection system, transmitters and input signals. The responsibility for this, or for the omission of regular maintenance work and the consequences are borne by the owner of the gas warning system, even if a maintenance contract is in place and service personnel have no access to the system.

## 1.9 Safety / Responsibility

The safety function is guaranteed if the gas detection systems, transmitters and other system components are regularly inspected i.e. once or twice a year by authorized and qualified personnel having obtained training by the KIMESSA staff for a specific product. The responsibility for compliance with rules and regulations rests with the owner or his representative, including for regular testing of the system as part of cyclical maintenance.



The applicable regulations for installation, operation and maintenance of gas detection systems for monitoring of combustible gases and oxygen, for example (EN / IEC 60079-29-2) and for monitoring of toxic gases such as (EN 45544-4) must be observed and complied with.

Switzerland,

see customary local guidelines, which are legally binding in the event of an incident (in Switzerland, SWKI- and SES gas and gases).



If the so called ex-gas sensors are connected it should be noted that the sensor is suitable for use in gas and dust explosion hazard areas (zone 2 and 22).

## 1.10 If Ex-measuring sensors are connected in hazardous areas the following must be observed:

### Safety information for hazardous areas

- Pay attention to the applicable
  - Regulations and specifications (ExVO, BetrSichV, etc.)
  - Requirements for testing of personnel ("qualified" person, TRBS 1203)
- Installation, commissioning and periodic inspection must be carried out by suitably qualified personnel ("authorized persons")
- Compliance with important data for explosion protection must be met through the labelling of the product
  - G= Gas, D=Dust
  - Equipment category 1,2,3 in the 3 zone areas
  - Characteristics of the gas: Temperature class (T1..T6), explosion group (IIA, B, C)
  - Dust characteristics: Explosion group (III A, B: non-conductive; IIIC: high conductivity); surface temperature, smoulder and ignition temperature

- The deposit of dust is to be avoided so that the surface temperature does not dangerously increase. (installation position, protection, cleaning measures, etc.)
- Care must be taken to ensure that all technical and organizational precautions are met and their function or effects are tested.
- If an "X" is present after the EC-Type Examination Certificate number, there are special stipulations or deviations from the standard conditions. In this case, these special instructions can be found in the certificate.
- Before any work (installation etc.) is performed in potentially explosive atmospheres, a work permit must be submitted by the operator.

If Ex-measuring sensors are connected in hazardous areas the following must be observed:



For work such as installation, electrical connection, repair or opening of the housing, it must be ensured that

- no explosive atmosphere is present
- no electric voltage is applied
- accidental activation is not possible
- there is a work permit from the operator

Changes to the equipment are not allowed and can lead to triggering an explosion (ignition)!

Additional information on use in potentially explosive dust atmospheres:

- The details of the maximum surface temperature are valid only for a dust allowance of more than 5 mm. At higher dust allowance the surface temperature must be reduced
- Determining the maximum permissible surface temperature
  - Dust with ignition temperature-TCL:  $T_{max1} = 2/3 \text{ TCL}$
  - Dust layer with ignition temperature-T5mm:  $T_{max2} = T_{5mm} - 75^{\circ}\text{C}$
  - The smaller of the two values is decisive for the maximum permissible surface temperature



- During installation and operation of the equipment, it must be ensured that no electrostatic charges (no high flow rate; cleaning with a damp cloth, etc.) occur on the plastic parts (type label, plastic housing).

### 1.11 Definition of the signal words

In this manual some warnings regarding some risks and hazards are used, which can occur when using the device. These warnings also include "Signal words" which should draw attention to the expected level of danger. The warnings with their signal words are as follows:

	<p>WARNING</p>	<p>Death or serious injury can occur due to a potential risk situation, if appropriate precautionary measures are not taken.</p>
---	----------------	--

#### Definition of the signal words

	<p>CAUTION</p>	<p>Personal injury, property damage or damage to the environment due to potentially hazardous situation can occur if appropriate precautions are not taken. Can also be used to warn against reckless approach</p>
---	----------------	--

	<p>NOTE</p>	<p>Additional information about the device</p>
---	-------------	--

	<p>Warning</p>	<p>Important notes, when ex-sensors used in potentially hazardous areas are connected. Danger of explosion - Please read</p>
---	----------------	--

### 1.12 Target group, electricians and maintenance technicians; personal protective equipment

	<p>When working on the gas detection system, use your personal protective equipment, safety boots, helmet, goggles, hand-held measuring instrument, respiratory protection and, if necessary, hearing protection and gloves. Please note the regulations concerning the transport and storage of gas bottles.</p>
---	---

	<p>Gas detection systems are used for protection of persons and property and may be retrieved or serviced only by trained personnel. A product training and authorisation by KIMESSA is compulsory.</p>
---	---



If at the **CANline 02** so-called ex-sensor is to be connected,  
it must meet the requirements for testing personnel (explosion protection)

Tester	Training	Experience	Timely action
"Trained" Person	✓ Instruction	<ul style="list-style-type: none"> <li>✓ Usage; application</li> <li>✓ Desired condition</li> <li>✓ Possible faults</li> </ul>	<ul style="list-style-type: none"> <li>✓ regular use</li> <li>✓ Annual training</li> </ul>
"Competent" person	✓ Technical Profession	<ul style="list-style-type: none"> <li>✓ Documented Experience</li> <li>✓ Ex systems, components</li> <li>✓ Testing/Evaluation</li> </ul>	<ul style="list-style-type: none"> <li>✓ Explosion protection</li> <li>✓ Technical rules</li> <li>✓ State of the art</li> <li>✓ Several tests per year</li> <li>✓ Update: Training; instruction</li> </ul>
"Competent" person explosion protection/ complete Ex-equipment (risk detection measures)	Studies technical Qualification	1 year ex-activity Ex systems, devices - Production - Assembly - Servicing for many years in safety technology	Explosion protection Technical rules State of the art regularly updated: -Further education -Exchange of experience

Requirements for the testing personnel (calibration / adjustment)

Personnel Qualification	Regarding		
	<ul style="list-style-type: none"> <li>➢ gas detectors</li> <li>➢ Recognition of changes in gas detectors</li> <li>➢ Testing of functionality and assessment of results</li> <li>➢ Training (complete 2years)</li> </ul>	<ul style="list-style-type: none"> <li>➢ Operational maintenance manual</li> <li>➢ Operation of devices</li> <li>➢ Measuring principle</li> <li>➢ Test gases used</li> <li>➢ Control functions</li> <li>➢ Calibration- adjustment</li> <li>➢ Assessment of results</li> <li>➢ Training (complete 2years)</li> </ul>	<ul style="list-style-type: none"> <li>➢ TRBS 1203: completed professional training experience, professional activity, timely checks of work tools and further training, Fire hazard and protection, authority to act independent of instructions.</li> <li>➢ Application and usage possibilities for gas detection systems</li> <li>➢ Measuring principle: Influence of interfering gases, detection limits, restrictions, maintenance</li> <li>➢ Physical, chemical properties of gases/vapours</li> <li>➢ Training (complete 2years)</li> </ul>
"Trained" Person	X		
"Qualified" professionals	X	X	
"Competent" person	X	X	X
"Competent" person	X	X	X (Explosion protection, regulations)

Target group, electricians and maintenance technicians; personal protective equipment

Responsibilities	People	Skills	Personal protective equipment
Design changes and amendments	Planners, architects, engineers	Knowledge of building, plumbing, and HVAC, air ventilation and refrigeration	as on building sites, safety boots, helmet, goggles, if gas is present, hand-held measuring instrument and respiratory protection in "normal operation" PSA is not necessary
Transport/storage	Parcel services, haulers, agents	Care and conscientiousness, no specific prerequisites	None
Electrical installation	Professionals in electrical engineering, electricians, electrical engineers, automation technicians, electronic technicians, master of the electrical trades, technicians and engineers	Safe handling of tools, laying electrical conductors, installation of electrical and electronic equipment by distributors, RCDs, line circuit breakers, electric motors, switches, buttons, sockets, etc. for measuring the effectiveness of electrical protective measures	as on building sites, safety boots, helmet, goggles, if gas is present, hand-held measuring instrument and respiratory protection
Commissioning, fault elimination and maintenance of the gas warning system and signal input	Technicians trained and authorized by KIMESSA for commissioning and maintenance	Safe handling of tools, laying electrical conductors, installation of electrical and electronic equipment by distributors, RCDs, line circuit breakers, electric motors, switches, buttons, sockets, etc. for measuring the effectiveness of electrical protective measures, product-specific training by KIMESSA, commissioning and maintenance of gas detection systems, dealing with measuring and testing equipment	as on building sites, safety boots, helmet, goggles, if gas is present, hand-held measuring instrument and respiratory protection
Operation and operation monitoring	Ownership, administration, user	Care and conscientiousness, no specific knowledge is required	in "normal operation" PSA is not necessary
Disposal	Employee representatives	the appropriate collection is performed according to EU Directive (2002/96 / EC)	None

## 2 Usage

### 2.1 Introduction

The universal KIMESSA *CANline 02* gas monitor has been designed to ensure safety of persons. The KIMESSA *CANline 02* gas detection control unit is a compact, economic evaluation unit, which is available in different versions and can handle up to 2 measurement channels.

In addition the 2 analogue/BUS sensors, several touch displays, relay cards and further modules can be connected to the *CANline 02* control unit. Aside from the 5 internal potential-free relays, there are up to 128 further potential-free, programmable relay contacts, which are provided with 3 alarm thresholds per measuring point and can be split into 2 fire/ventilation zones or groups. The *CANline 02* control unit also has an alarm for over- and undershooting the measurement signal, with which relevant relays can be programmed that then, for example, visualize a fault accordingly.

Pressing the SELECT button shows the values of individual sensors. The RESET button is used to reset the system when limits are exceeded. The control unit has a history function that documents and displays limit exceedances and errors from the connected sensors precisely to the second. The parameters of the sensor and the entire system can be programmed with the integrated USB interface.

In conjunction with the KIMESSA BUS sensors, there are many cost-saving cabling possibilities, which also include connecting in KIMESSA BUS signals so that only one cable has to be run. Other features include the ability to record over long periods of time using a MicroSD memory card.

The *CANline 02* gas detection control unit comes in a panel-mount version as well as in the standard wall-mounting housing, each with an integrated power supply.

### 3 CANline 02 Construction

The **CANline 02** consists of a lower part and an upper part, plastic, grey, RAL 7035. The lower part comes with mounting holes and carries the cable relief and cable glands for the connection cable between the sensor and the power supply. The connector circuit board in the lower part of the housing contains the 230 Vac power supply, Wago connection terminal plugs for 2 analogue sensors, the terminals connector for the KIMESSA CAN BUS, a Modbus RTU connection, a ground terminal, 5 potential-free relay outputs with corresponding connection terminal plugs and fuses. The lower part of the housing is connected to the upper part with plastic brackets, ensuring that the connection terminal plugs are open and accessible. The circuit board in the housing cover also carries the circuit board for the OLED display and the service port (USB2 cable) for programming with a computer. On the outside of the housing cover, there is a front panel foil and the display for operation and visualization of measured values, as well as 3 control buttons concealed under the front panel foil.



Dimensions:

L.: 230 mm  
W.: 130 mm  
H.: 90 mm

Weight: 1100 gr.



**Upper part** with CPU board,  
display for operation and visualization of measured values  
3 adjustment buttons (keypad)  
Connection pin socket (P3), for connecting cable and USB  
cable, DIP switch and a button battery

**Lower part** with cable leads,  
connector circuit board with power supply,  
connection terminal plugs for  
analogue sensors, KIMESSA CAN BUS and Modbus RTU  
port (RS485), configuration jumper  
relays, fuses and ground terminal

## 4 Installation

### 4.1 Conditions of use/Installation/Where and how will the control unit be mounted?

The control unit housing is neither water-proof nor explosion-proof. The monitor should be placed in a dry and non-hazardous area. It can be installed directly onto the wall or into a cabinet.

The ambient temperature for the operation of the CANline 02 gas detection control unit should be between -10 °C to 40 °C. The relative humidity must be between 5% RH (relative humidity) and 95% RH. Ideally, the unit is installed vertically on the wall or in a cabinet (plastic/metal). For installation in the control cabinet, for example on a DIN rail, two nuts are inserted (metal piece with threading) and secured directly into the rail. For installation onto the control cabinet door, there is a mounting frame. The cable glands are mounted on the lower part of the CANline 02 housing, facing downwards. It is important to ensure that the gas detection control unit is always accessible. Note that the upper part of housing opens upwards for wiring, programming and during maintenance work. It may be necessary to secure the gas detection control unit in exposed locations with a mechanical bumper buffer device/ram protection. When cleaning in its vicinity, do not expose the control unit to any contamination and avoid splashing water and vapours.

If ex-sensors are used, refer to the following for ex-sensor installation:

Before the unit (ex-sensor) is installed, the following checks must be carried out

- The device must not show any damage or other conspicuous changes
- The IP protection of the device must conform to the operational and environmental conditions
- The operator must have already defined zones
- Check whether the device category corresponds to the predefined zones
- Check the product documentation, whether any upstream safety devices (fuse, etc.) are required
- Specification of ex-technical requirements, safety characteristics of the potentially explosive substances, zone areas, ambient temperatures

The following standards and rules are helpful

- BGR-104: Explosion protection regulations
- EN 1127-1: Explosion protection basics and methodology
- TRBS series

Standards for potentially explosive areas

- EN 60079-10-1: Classification of potentially explosive areas
- EN 60079-10-2: Classification of areas with a dust-induced risk of explosion
- EN 60079-14: Installation of electrical equipment in hazardous areas
- EN 60079-17: Inspection and maintenance

Observing the primary task of supervision at gas detectors:

- Direction of propagation of the gases  
Upwards, if the gas is lighter than air (natural gas, hydrogen, etc.)  
Downwards, if the gas is heavier than air (almost all gases)
- Areas in which gases appear:  
In the vicinity above or below a potential leakage point
- Areas in which gases accumulate:  
In the upper and lower spaces of a room
- Health protection with regard to toxic gases and oxygen:  
Position, mouth height approx. 1.6m

Additional information on use in potentially explosive dust atmospheres:

- The deposit of dust is to be avoided so that the surface temperature does not dangerously increase. (installation position, protection, cleaning measures, etc.)
- During installation and operation of the equipment, it must be ensured that no electrostatic charges (no high flow rate; cleaning with a damp cloth, etc.) occur on the plastic parts (type label, plastic housing).

## 4.2 Mechanical installation of CANline 02



When working on the gas detection system, use your personal protective equipment, safety boots, helmet, goggles, hand-held measuring instrument, respiratory protection and, if necessary, hearing protection and gloves. Please note the regulations concerning the transport and storage of gas bottles.



The applicable regulations for installation, operation and maintenance of gas detection systems for the monitoring of combustible gases and oxygen (EN/IEC 60079-29-2) and for the monitoring of toxic gases (EN 45544-4) must be observed and upheld.

Switzerland: see customary local guidelines, which are legally binding in the event of an incident

Unpack the gas detection control unit and check for missing parts or transport damage. Also check the technical specifications. Compare the nameplate with the actual product that you ordered. Be especially careful if additional assembly aids are present, such as mounting plates or installation frames.

Open/close the gas detection control unit, remove it from/install it via the back panel by screwing in/unscrewing the housing screws (M3 flat screwdriver or M3 Phillips head screwdriver).

Install the control unit directly on the wall or in the control cabinet on DIN rails or on/in the control cabinet door.

After installation, attach the upper part again (plastic brackets). Close the control unit and check the fit: If the back panel is properly installed, the control unit closes easily.

4.3 Delivery contents, CANline 02 gas detection control unit



4.4 CANline/opening/closing the control unit

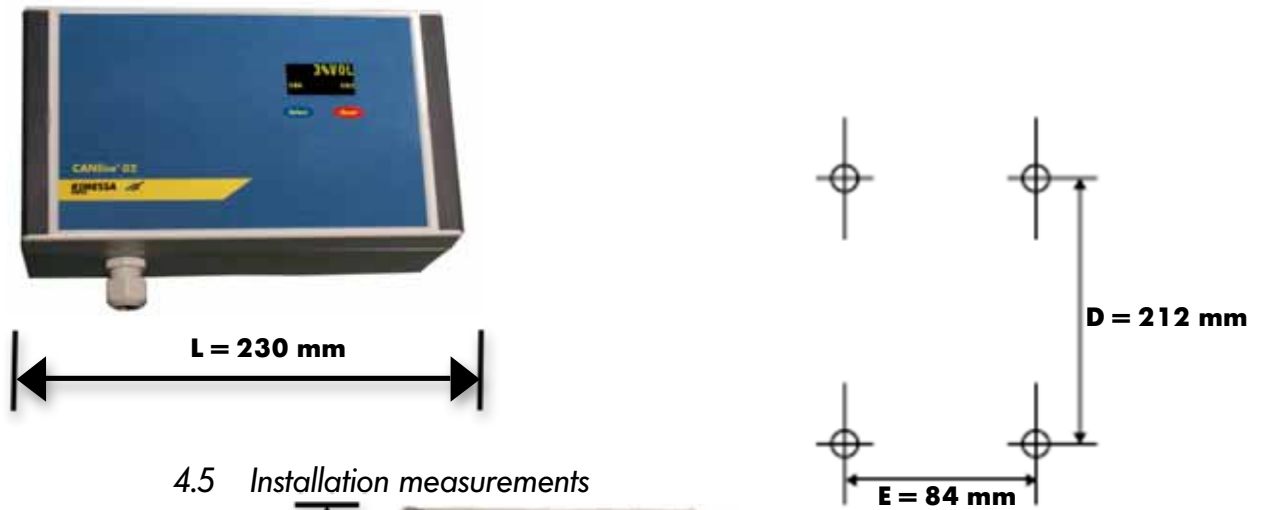

4.5 Installation measurements

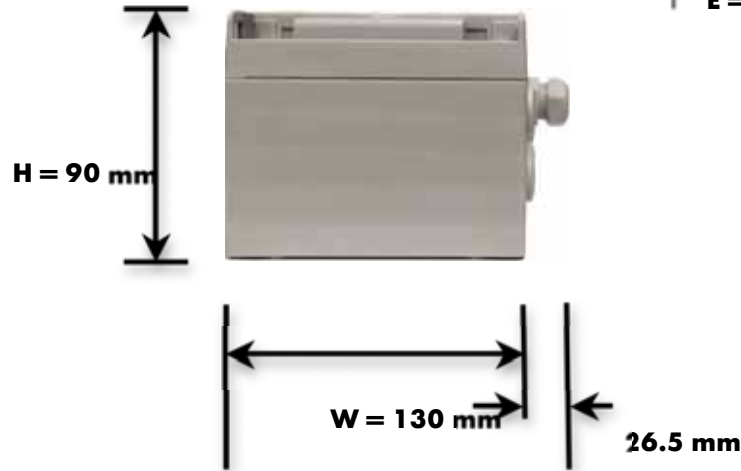

Open/close the gas detection control unit, remove it from/install it via the back panel by screwing in/unscrewing the housing screws (M3 flat screwdriver or M3 Phillips head screwdriver).

#### 4.6 Electrical installation/Connecting the control unit



Risk of electrical shock!  
Electrical operations should only be performed by qualified electrician personnel.  
Before opening the unit, disconnect power and secure against inadvertently restarting the power.



When working on the gas detection system, use your personal protective equipment, safety boots, helmet, goggles, hand-held measuring instrument, respiratory protection and, if necessary, hearing protection and gloves.  
Please note the regulations concerning the transport and storage of gas bottles.

#### 4.7 T2 Amp Fuses

All relay outputs are safeguarded with T2Amp (5x20mm). They are located beneath the cover.

#### 4.8 Power supply

The control unit is powered with 230 VAC/0.9 A. Optionally, the control panel is also available as a 24VDC version. In addition, the number of externally connected nodes should be noted. Their power consumption should be added to the total power.

#### 4.9 Sensor-Cable BUS-Installation

Recommended: 4-Core control cable, shielded

Cable diameters/Distances

Data transmission is guaranteed up to approx. 1000 m. The power consumption of each node must be added together.

In each case, the cable cross section must be calculated. The length of the + wire and the -wire and the total power consumption must be taken into consideration



## 4.10 KIMESSA-Cable

Recommended:

KIMESSA –Electronic cable, shielded  
1506.2 ZK CAVO LIHCH 4x1.00 (30x0.200) DIN 47100 - GIALLO 1021 Ø 7.10-40°C / +70°C -

These shielded cables for flexible application, free-moving without tensile load or forced movements, are suited for installation in dry environments and may not be used outside of buildings. LIHCH cable for



electronic, computer, measurement and control systems can be used wherever cables with small external diameters are required. The insulation and sheath are made of a special plastic (LSZH) which prevents halogen gases from being emitted in the case of a fire. KIMESSA electronics cables are therefore suitable for installation in public buildings (hospitals, theaters, etc. ). The good protection by the shield of a thin and effective copper braid allows for interference-free signal and impulse transfer. The use of KIMESSA electronics cable is recommended especially for safety-critical systems in public facilities and plants with high reliability requirements.

### Cable structure

Description	Construction	Diameter	Thickness
mm <sup>2</sup>	No. / mm	mm	mm
1.00	30x0.20	2.10	0.43
Inner conductor	Copper, cold drawn		
Insulation	Thermoplastic, halogen-free TI6		
Identification	Coloured		
Cable structure	Conductor in concentric layers		
Strands	Coated with flexible plastic, stranded		
Supporting element	Polyester film		
Shielding	Copper braid, tinned		
Cable sheath	Thermoplastic, halogen-free TM7		
Cable colour	Yellow RAL 1021		

### Cable diameters/ Distances

Data transmission is guaranteed up to approx. 1000 m. The power consumption of each node must be added together. In each case, the cable cross section must be calculated. The length of the + wire and the -wire and the total power consumption must be taken into consideration

e.g., total cable length approx. 750 m/ cable cross section 0.75 mm<sup>2</sup>

Cable resistance at 1000 m = 26 ohms  $26 \Omega / 1000 \text{ m} \times 750 \text{ m} \times 2 = 39 \Omega$

20 gas sensor KSEC 504 → at 20 mA → 0.4 A

$U = R \times I / U/I = R$

Power supply 24 VDC

Total power  $0.4 \text{ A} \times 39 \Omega = 16 \text{ VDC}$

☺ 16 Volt at the end of the cable is just enough; less than a 16 VDC supply is too small for the CO sensor.

### 4.11 Electrical installation/EMC and ATEX

The cable is stripped to the desired length and a second round section is attached so that a sliding piece with a length of 15-20mm, depending on the cable diameter.

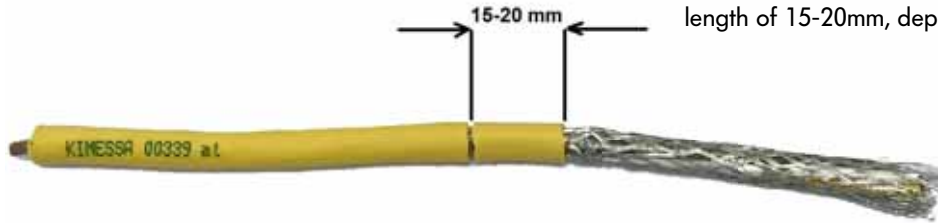

The protruding transparent plastic auxiliary coat and the braided rosette are unwinded and cut with a side cutter

Braided shield

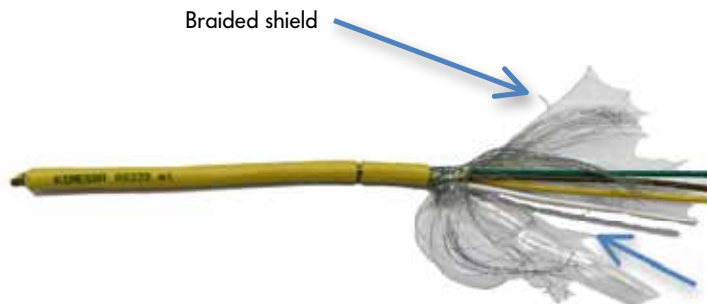

Plastic auxiliary coat, transparent (for production reasons)

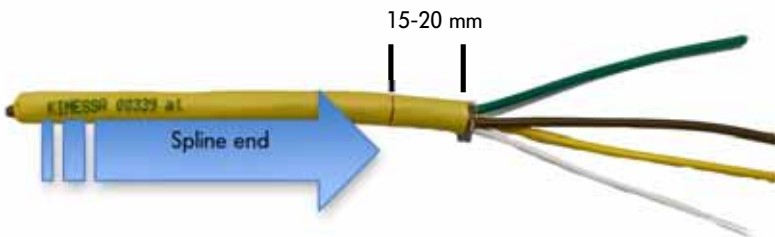

The sliding piece now stripped toward the Stripped and cable gland - 15 to 18 mm. Using two fingers press the spline end together and slide towards the cable coat, so that a braided shield forms a rosette.

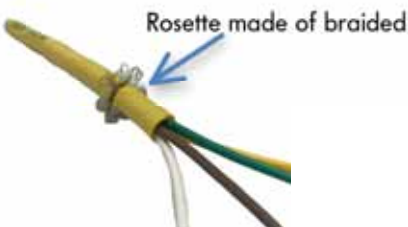

Shielded cable

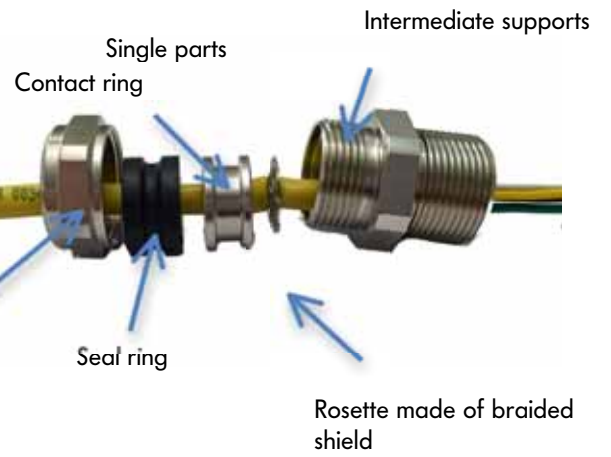

The cable is then inserted into the gland and the screw joint is put together; make sure that the braided shield rosette is installed correctly. Use an appropriate open-end wrench to tighten the cable gland (the size depends on the type of screw joint).

 Gland body and nut must be tightened with a torque of 20 Nm



During tightening the gland, hold the cable tight with the other hand. This way the braided shielded Rosette keeps its position.



Risk of electrical shock!

Electrical operations should only be performed by qualified electrician personnel. Before opening the unit, disconnect power and secure against inadvertently restarting the power.



When in a potentially explosive area, make sure:

- to check whether the device category corresponds to the predefined zones
- no explosive atmosphere is present
- there is a work permit from the operator
- to comply with applicable rules
- to ensure that the documentation of the devices used in operations such as installation, electrical connection, repair or opening of the housing is complete
- no electric voltage is applied
- accidental activation is not possible

The transmitter supply line must be shielded or the supply line must be laid in metallic cable routing. If an unshielded supply line is used, it must be ensured that no other current-carrying line is run along the same conduit, see Transmitter Datasheet. The supply line must be X-wired (see Transmitter Datasheet) and is limited by the terminal port in the transmitter to 1.0 mm<sup>2</sup>.

- Selecting connection cable
  - When selecting the cable, the following points should be noted:
    - Select cable material with regard to the local resistance requirements
    - ?-wired standard cable with shield
    - Conductor cross-section: 1 mm<sup>2</sup>
    - Cable diameter 7.1 mm, KIMESSA special cable
- Running cable
  - If risk of mechanical damage is possible, the cable must be appropriately protected (protective tube, etc.)
  - The cable diameter must be complied with so that the connection in the cable entry point remains tight
  - The gland and the screws of the housing cover must be tightened so that IP protection is maintained. Excessive pulling damages the seal and thus affects the IP protection
- Grounding system
  - The external grounding terminal on the housing must be connected to the potential equalizer of the hazardous area with low resistance
  - No potential equalization currents may flow between hazardous areas and non-hazardous areas.
  - Minimum cross-section: 2 x 1.5 mm<sup>2</sup> or 1 x 4 mm<sup>2</sup>
  - Ground connection of the electrostatic charge with a resistance between 0.2-1 MOhm does not qualify as grounding

## Electrical connection of sensors and explosion sensors



- Make sure that the lines to be connected are not energized. Otherwise, there is a risk of damage to the unit and of igniting an explosive atmosphere!

Before the device is supplied with voltage, the following inspections (TRBS 1201) must be carried out:

- Inspection of order:
  - if the equipment used complies with all safety-related parameters (device category, surface temperature.)
  - if the documentation is complete and comprehensive (permits, regulations, certificates, checks to be carried out, etc.)
- Technical inspection
  - Screws, for a tightness of
    - ✓ connection, protective and potential equalizer terminals
    - ✓ housing cover
  - Torque of the cable entry point
  - Tightness between cable and seal in the cable entry point
  - Check whether the device is ready for operation
    - ✓ The parameterization for this application must be carried out
    - ✓ All interfaces such as inputs and outputs for control purposes must be connected and ready.

## 5 CANline 02 Connections



Do not interchange wires; risk of destruction!  
For BUS operation: Pay attention to bus-end resistors and jumper positions!

Strip the wires to 6 mm, then connect to the appropriate connector terminal and make sure that all individual wires (especially stranded wires) are clamped

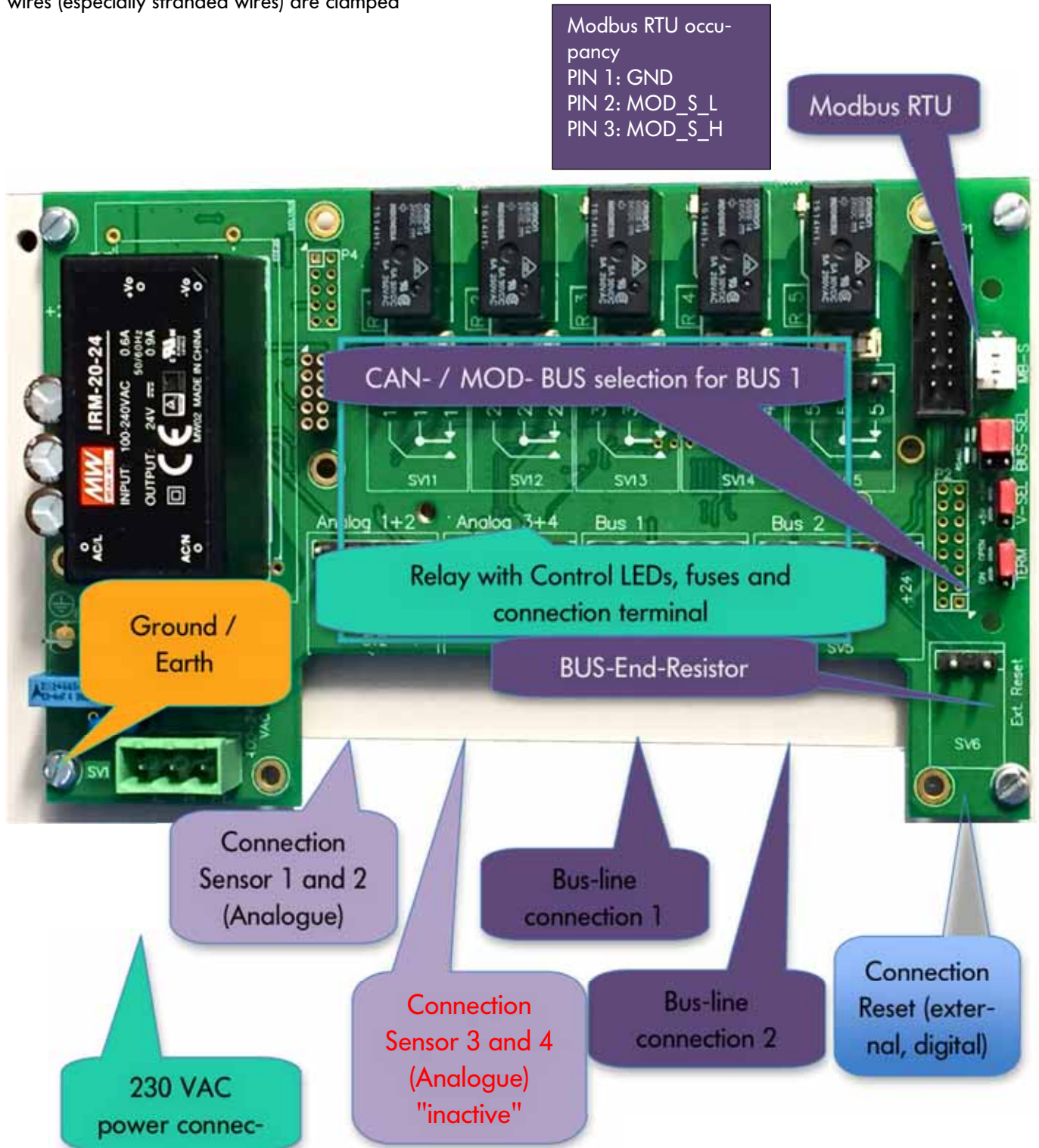

### 5.1 Wiring Schematic for 2 x 4..20mA detectors

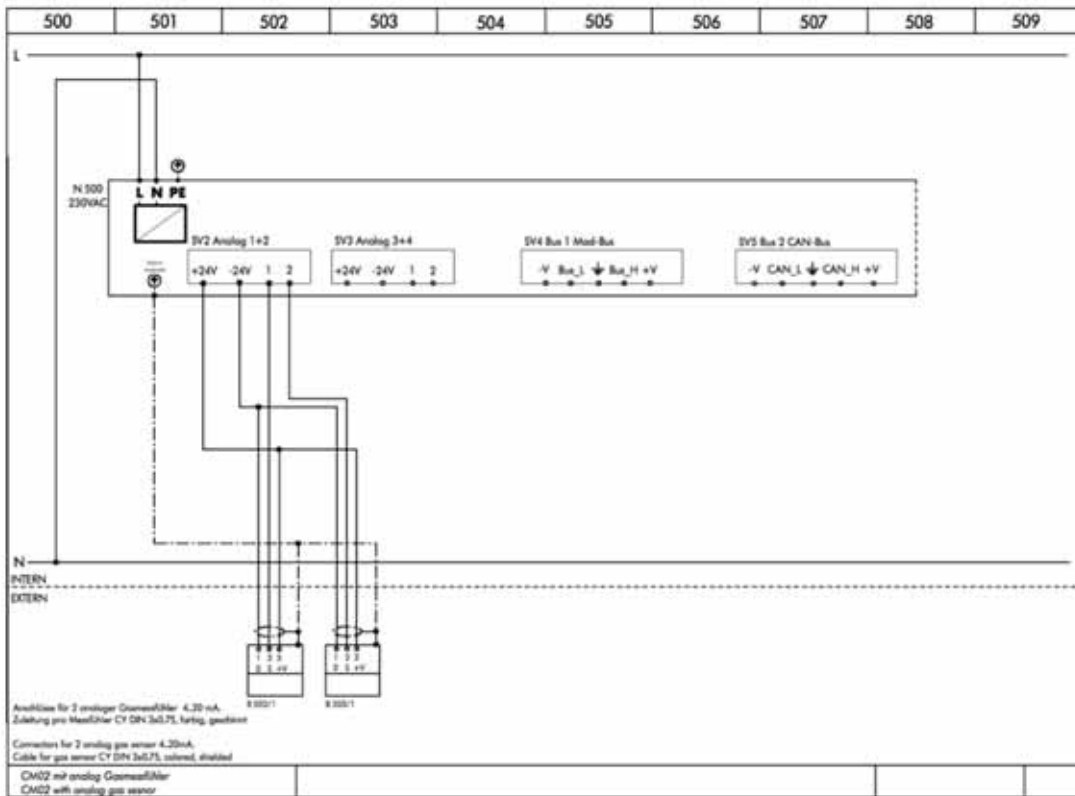

### 5.2 Wiring Schematic for 2 x digital BUS detectors

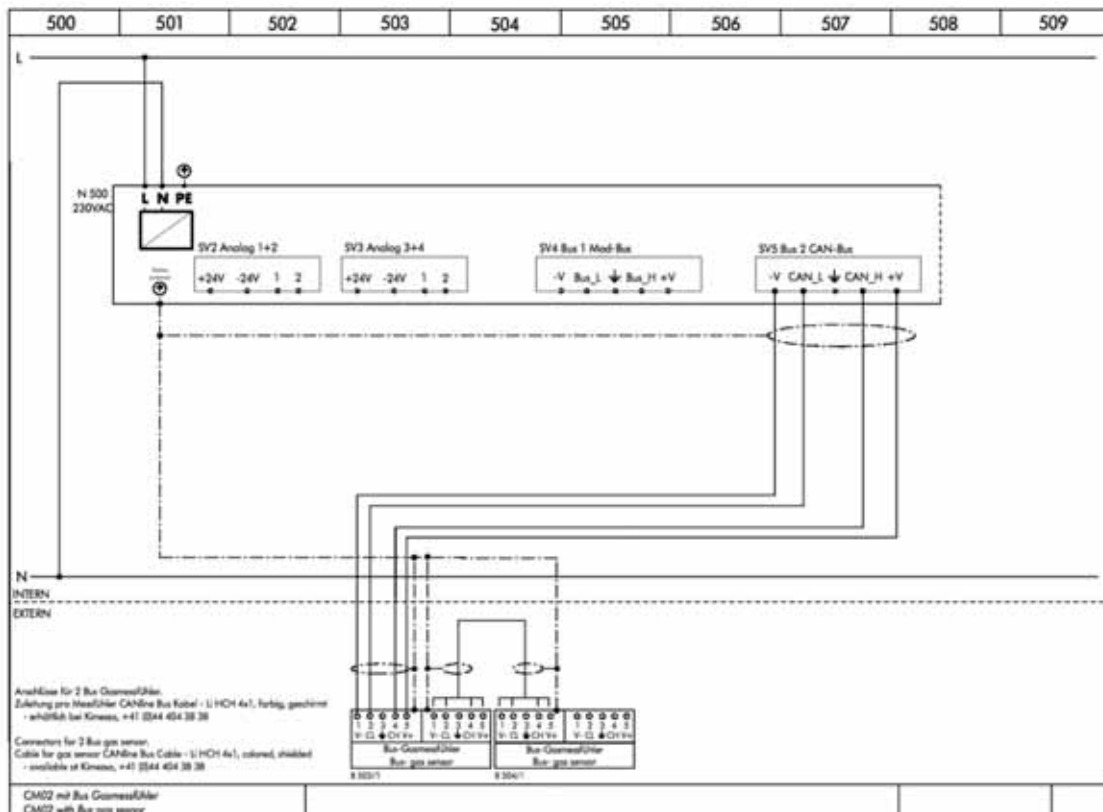



### 5.3 Wiring Schematic for really contactst (standard)

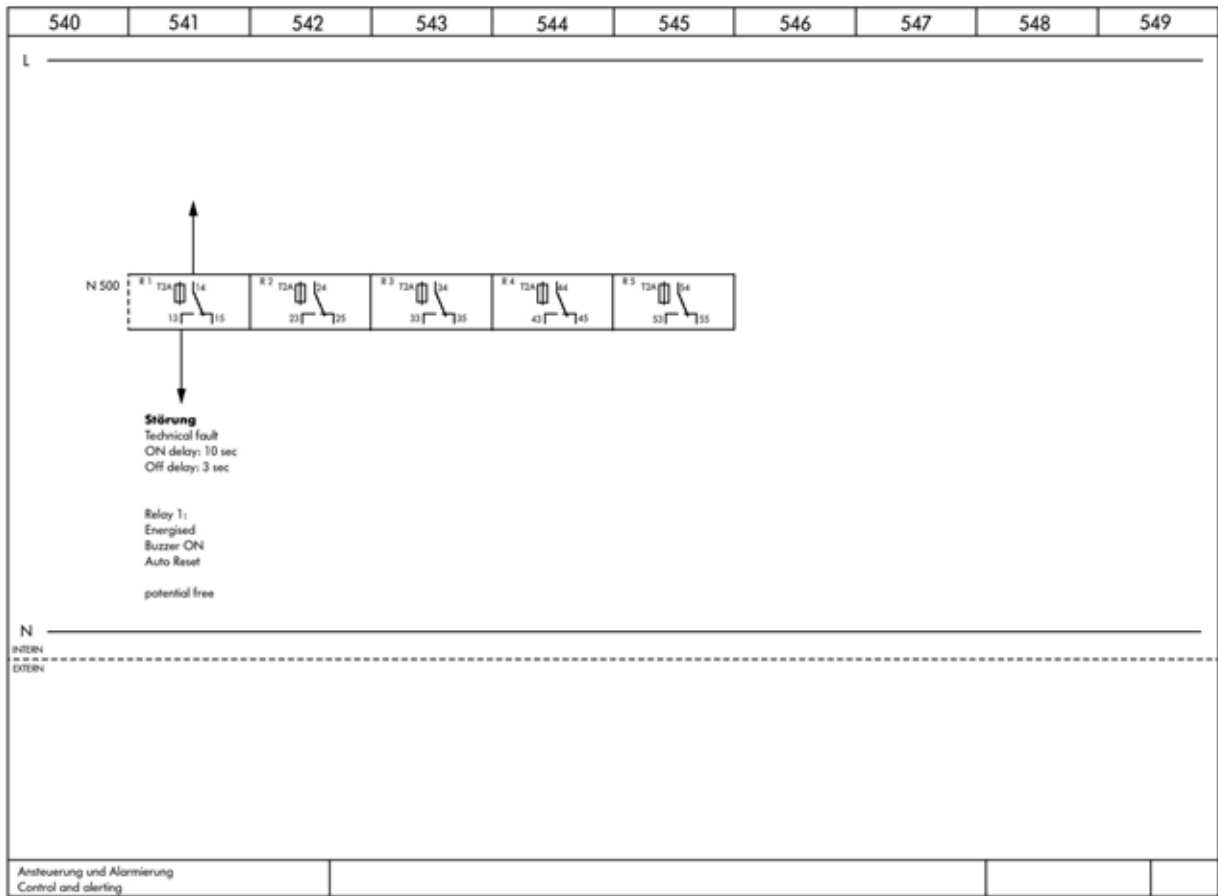



## 6 User comfort

### 6.1 Front view, dimensions and control elements

Dimensions:

Height 90 mm  
 Width 230 mm  
 Depth 130 mm

Weight 1.10 kg



### 6.2 Front functions

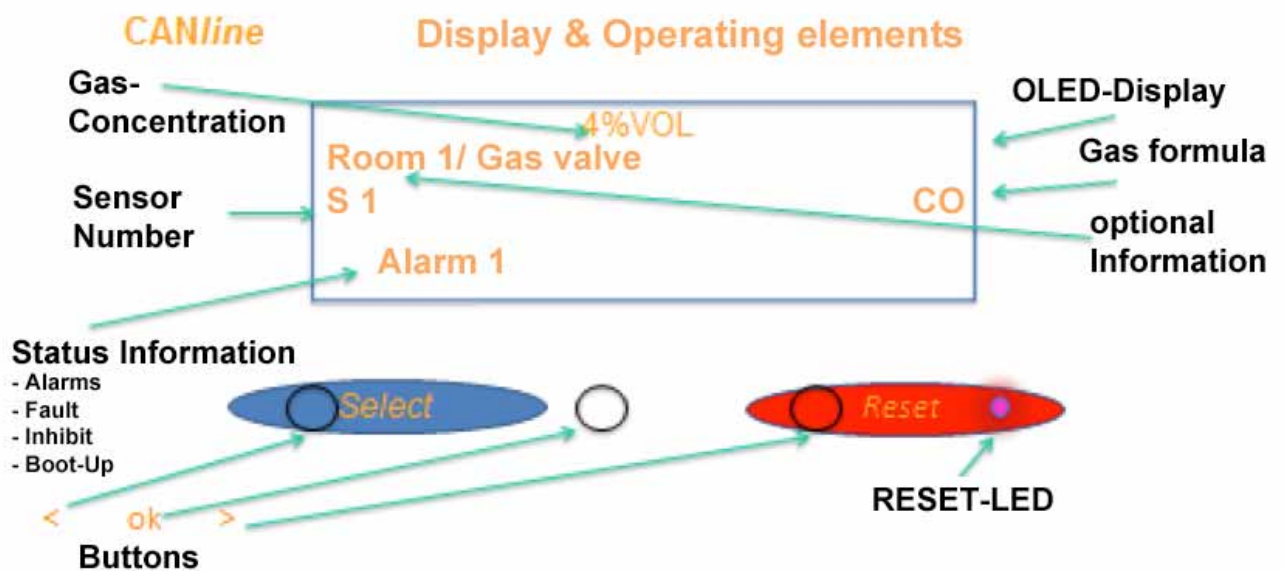

### 6.3 Alarm reset

With "standard programming," an alarm can only be acknowledged with the "RESET button" or by remote reset, if the alarm has been overstepped again.

With the appropriate programming of the CANline 02 control unit, in the event of an alarm, the acoustic alarm (signal horn) can be turned off by pressing the "RESET button" or by remote reset.

In any case, an alarm is triggered before the horn can be switched off; there is always an alarm.

### 6.4 "Switch to inactive" button function, one sensor

The sensor from which the alarm goes off is switched to inactive.

It is selected using the "Select" button for the corresponding sensor and then the "Select" and the "RESET" buttons simultaneously. After 20 seconds, an audible beep (100 milliseconds) will be heard and the buttons can be released.

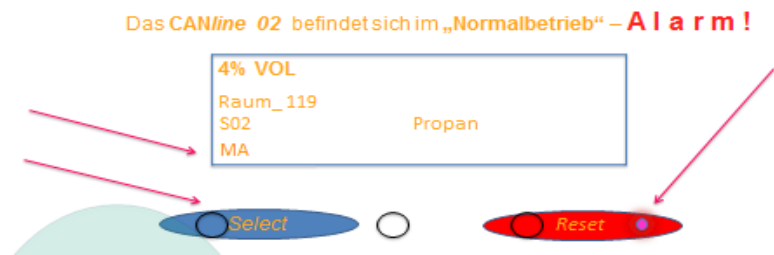

The same procedure can be performed in order to manually reactivate the sensor.

The selected sensor is then switched to "inactive" for a period of 4 hours. After 4 hours, the sensor is automatically reactivated if it has not already been activated manually.

### 6.5 "Switch to inactive" button function, several sensors

Simultaneously press the "Select," the "OK" and the "RESET" buttons. After 20 seconds, an audible beep (100 milliseconds) will be heard and you can release the buttons.

The same procedure can be performed in order to manually reactivate the sensors.

All sensors are then switched to "inactive" for a period of 4 hours. After 4 hours, the sensor is automatically reactivated if it has not already been activated manually.

## 7 Switching on

After switching on the CANline 02, the firmware is loaded and various status messages are displayed until the "boot up" sequence, which also serves to stabilize the sensors. Pellistor sensors, particularly, need to warm up. This can be cancelled with the "RESET" button.



As seen on the display (right), the menu can be accessed by using the buttons.



## 8 Main Menu

### CANline 02 Menu Item - Main Menu

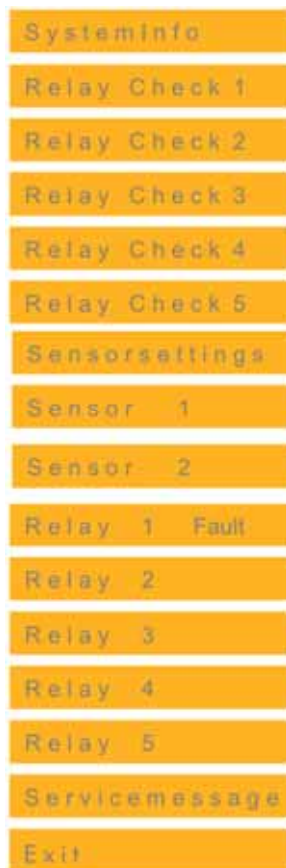

You can quit the menu at any time by pressing the SELECT + OK buttons

*Note: !!!*

*The points:*

- Sensor Settings
- Sensor 1 and Sensor 2
- Relay 1 - Relay 5

*are only in the visible variation, which allows for programming the CANline 02 control unit via the buttons.*

## 8.1 Normal operation / sensor display

In "normal mode" the display will indicate the sensor with the highest gas concentration.

Display of a selected sensor: By pressing the SELECT button, the display will show "Sensor 1 - xx" (last programmed sensor). By pressing the SELECT button again, the next sensor is displayed until the desired sensor appears. Now, the display remains on the selected sensor until it is pressed again to release the SELECT button.

Display of the sensor with the highest measured concentration

By pressing the SELECT button twice, use the ">" button" to choose Alarm History 1, thereby displaying the sensor with the highest value.

## 8.2 First steps to the Menu

CANline 02 Der erste Schritt ins Menu und zur Programmierung

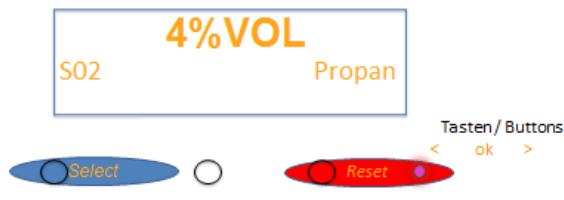

Pressing the "Ok" button takes you to "System Info".

Starting from the "System Info," with the "**>**" **Button (reset)**

Proceed sequentially through the menu (shown at left). With the

"**<**" **Button (Select)**

move backwards through the menu. With the "**Ok**" **button**

open the selected menu item to find system information, or to program.

If the "Exit" function is selected and is confirmed with "Ok", you will return to "Normal operation".

If you are within a menu and "Exit" is selected and then "okay" is pressed, you will return to the Menu structure, shown at left.

CANline 02 Die erste Information ist die Systeminformation

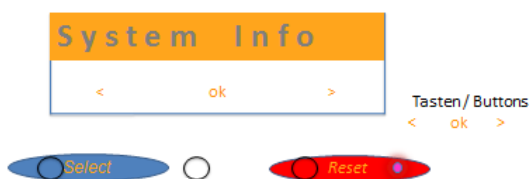

If you are in the

Menu, the respective menu item is highlighted in yellow, and the buttons Previous "<" ; "Ok" and forward ">" are visible in the display

### 8.3 System Info Menu

The submenu System Information, and the submenu Alarm History 1 - 10 display system-related information; only the date (Date) and time (Time) can be set directly in this menu.

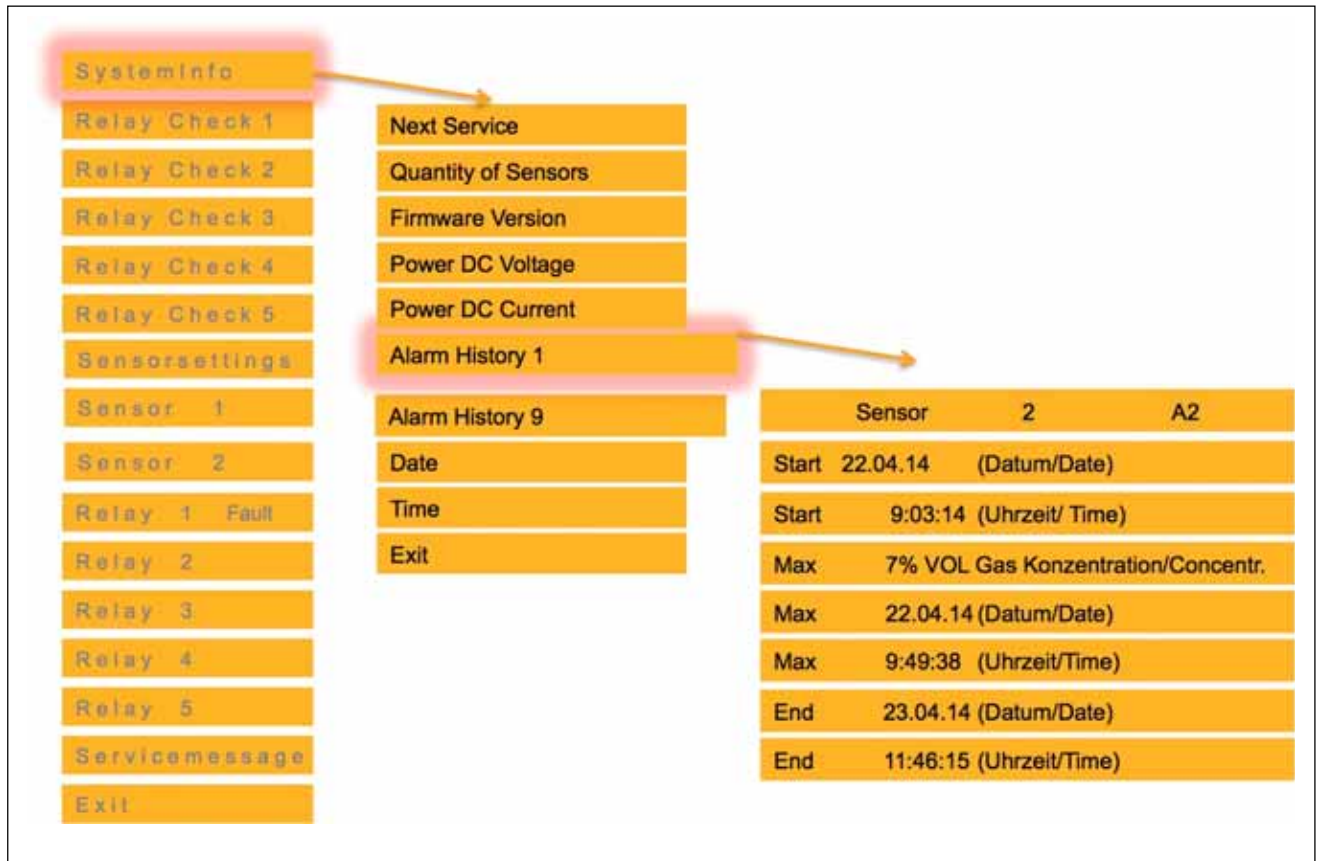

### 8.4 Next Service - System Info -

Indicates when the next service is due, which is merely informational, and the setting of the interval is done in the submenu "Service Message -Set Service interval".

Resetting the message

"Service Now"

can be done in the submenu

"Service Message Service Reset Now,"

whereby the display of the message returns to

"System Info Next Service" in the menu without changing the setting of the interval.



Input:

for "Normal operation," "OK" button; for "System Info," "OK" button; for "Next Service,"

Return to "normal operation" by pressing the ">" button or "<" button until you reach "Exit": "OK" button; for "System Info,"

with ">" button or "<" button until you reach "Exit": "OK" button: for "Normal operation"

## 8.5 Quantity of Sensors - System Info

In the "System Info - Quantity of sensor" menu, the number of programmed sensors appears. The setting of the sensor-count follows in the sub-menu "Sensor Settings - Quantity of sensor"

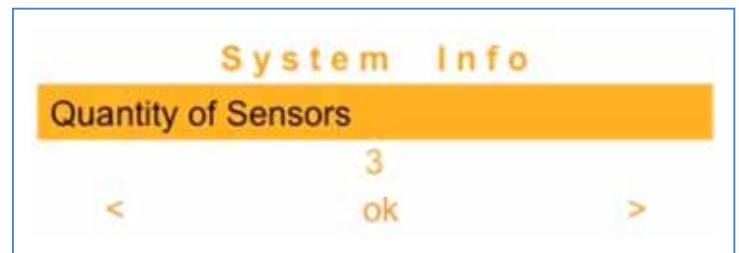

Input:

for "Normal operation" "OK" button; for "System Info," "OK" button; for "Next Service," ">" button; "Quantity of sensor"

Return to "normal operation" by pressing the ">" button or "<" button until you reach "Exit": "OK" button; for "System Info,"

with ">" button or "<" button until you reach "Exit": "OK" button: for "Normal operation"

## 8.6 Firmware version - System info

In the menu "System Information - Firmware version" only the factory-loaded firmware version appears. The version display changes automatically when a different firmware version is loaded.

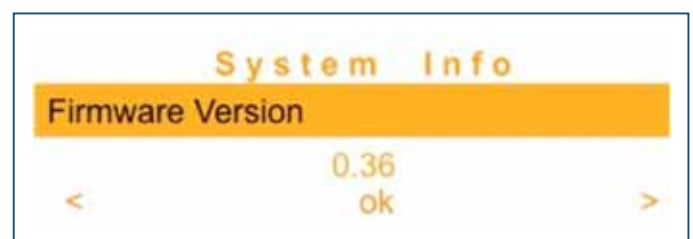

Input:

for "Normal operation," "OK" button; for "System Info," "OK" button; for "Next Service," ">" button; „Quantity of Sensors“: „>-button“; „Firmware Version“

Return to "normal operation" by pressing the ">" button or "<" button until you reach "Exit": "OK" button; for "System Info,"

with ">" button or "<" button until you reach "Exit": "OK" button: for "Normal operation"

## 8.7 DC Voltage Info - System Power

Information, there is no adjustment!  
Only the voltage at terminal "+V" will be shown, in volts, which can also be measured at this terminal, see the first connection configurations.

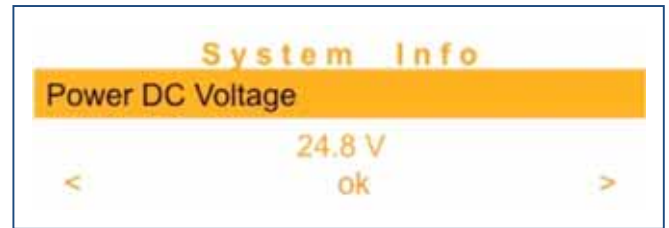

Input:

for "Normal operation," "OK" button; for "System Info," "OK" button; for "Next Service," ">" button; "Quantity of sensors": ">" button; "Firmware version": ">" button; "Power DC Voltage"

Return to "normal operation" by pressing the ">" button or "<" button until you reach "Exit": "OK" button; for "System Info," with ">" button or "<" button until you reach "Exit": "OK" button: for "Normal operation"

## 8.8 Power DC Current - System Info

Information, there is no adjustment!  
The total dc current demand of the power supply is displayed in mA. The total current varies with the number of sensors or according to the event, for example, if gas is being measured.

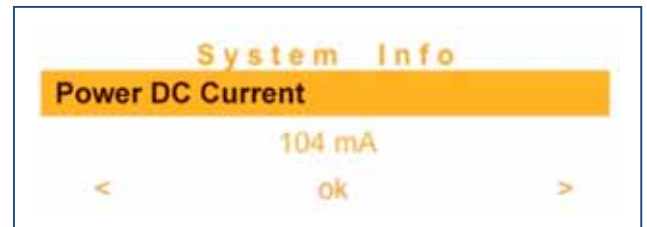

Input:

for "Normal operation" "OK" button; for "System Info," "OK" button; for "Next Service," ">" button; "Quantity of sensors": ">" button; "Firmware version": ">" button; "Power DC Voltage": ">" button; "Power DC Current"

Return to "normal operation" by pressing the ">" button or "<" button until you reach "Exit": "OK" button; for "System Info," with ">" button or "<" button until you reach "Exit": "OK" button: for "Normal operation,"



## 8.9 Alarm History 1 ... 10 - Sensor 3 Alarm - History 2 - System Info

In a buffer memory, the last 10 measured maximum values for alarm overruns or sensor faults are displayed.

For each maximum value, it displays:

Start date (when the limit is exceeded)

Start-time (when the limit is exceeded)

the maximum gas concentration,

Date at maximum gas concentration,

Time at maximum gas concentration,

End-date (when it falls below the limit),

End-time (when it falls below the limit).

The last event exceeding the limit appears in Alarm History 1. Whenever a limit is exceeded

it is recorded in the buffer memory in the Alarm History 1 at which

time the previous incident exceeding the limit will then be recorded in the Alarm History 2.

The data of the Alarm History 9 are represented as

Alarm History 10

and the data of the previous

Alarm History 10 are no longer visible.

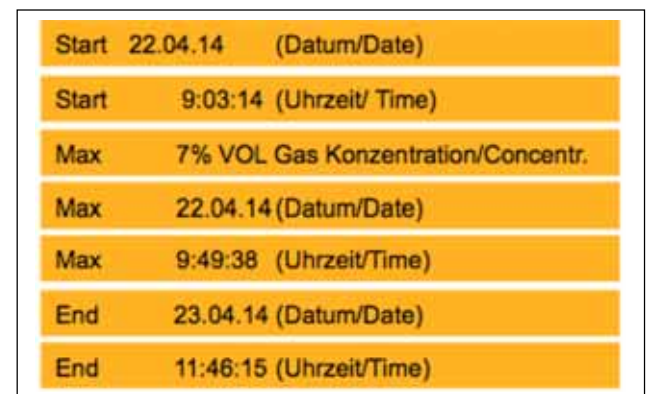
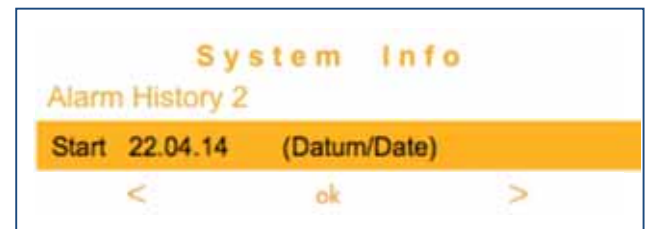
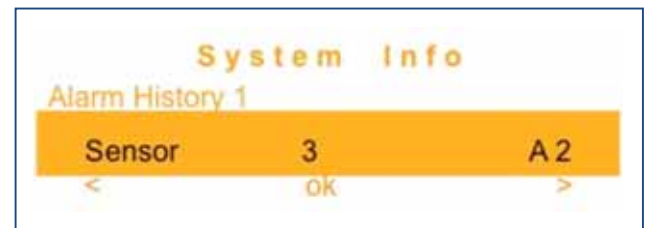

Input:

for "Normal operation," "OK" button; for "System Info," "OK" button; for "Next Service," ">" button; "Quantity of sensors":

">" button; "Firmware version": ">" button; "Power DC Voltage": ">" button; "Power DC Current"

"Alarm History 1 ... 10" (get from one Alarm History 1 ... 10 to the next one with the ">" button).

When by pressing the ">" button you reach the desired alarm history, use the

"OK" button to get into the sub-menu of Alarm History and then use the ">" button to reach "Start" (date) and continue

with the ">" button until the menu item "End" (Time)

Back in the "normal operation," for each menu item, suchs "end-time," with the "OK" button go back to the "Alarm History 1 ... 10" and then the ">" button or the "<" button to "Exit": "OK" button; for "System Info," with ">" button or "<" button until you reach "Exit": "OK" button: for "Normal operation"

## 8.10 Relay Check 1 ... 5 / Menu Structure / System Info



### CANline 02

### Menu Structure - Relay Check

In the menu "Relay Check 1 ... 5", the relays can be manually activated. This is indicated by the green LEDs on the printed circuit board in the device and the LEDs on the front panel R1, R2, R3 and R4. "Relay check" is a purely **Test function**, to control relay wiring, e.g. on an alarm device such as a light or buzzer.

With the function "Relay check," the function of the relays is checked. In the menu, to get to the submenu, "Relay Check 1 ... 5" is selected. By pressing the "ok" button twice, you get into the Setting level and can go, with the

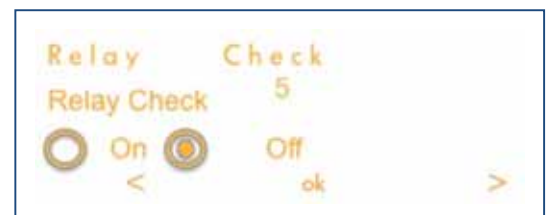

">" button and "<" button, between the ON and OFF switch; you can hear the selected relay switch, and the status LED on the front panel shows the change.

Input:

for "Normal operation" "OK" button; for "System Info," "> Button"; "Relay Check 1 ... 5": "Relay check": "OK" button; "ON / OFF" with "<button /> button" the selected relay's control LEDs light up.

Return to "normal operation" with the "OK" button; for "Relay check," "<" button or "<" button unto "Exit": "OK" button; for "Relay Check 1 ... 5," "> Button" or "<button" until "Exit" "OK" button: for "Normal operation"

The "OK" button returns you to the previous menu.

Using the ">", "<" and the "OK" buttons you can go to the next menu item

"Service Message"

### *8.11 Exit to main menu*

**Exit**

Likewise, by using the button functions ">", "OK / SELECT" and ">" buttons you can return to the main menu.

### 8.12 Exit to "normal operation"

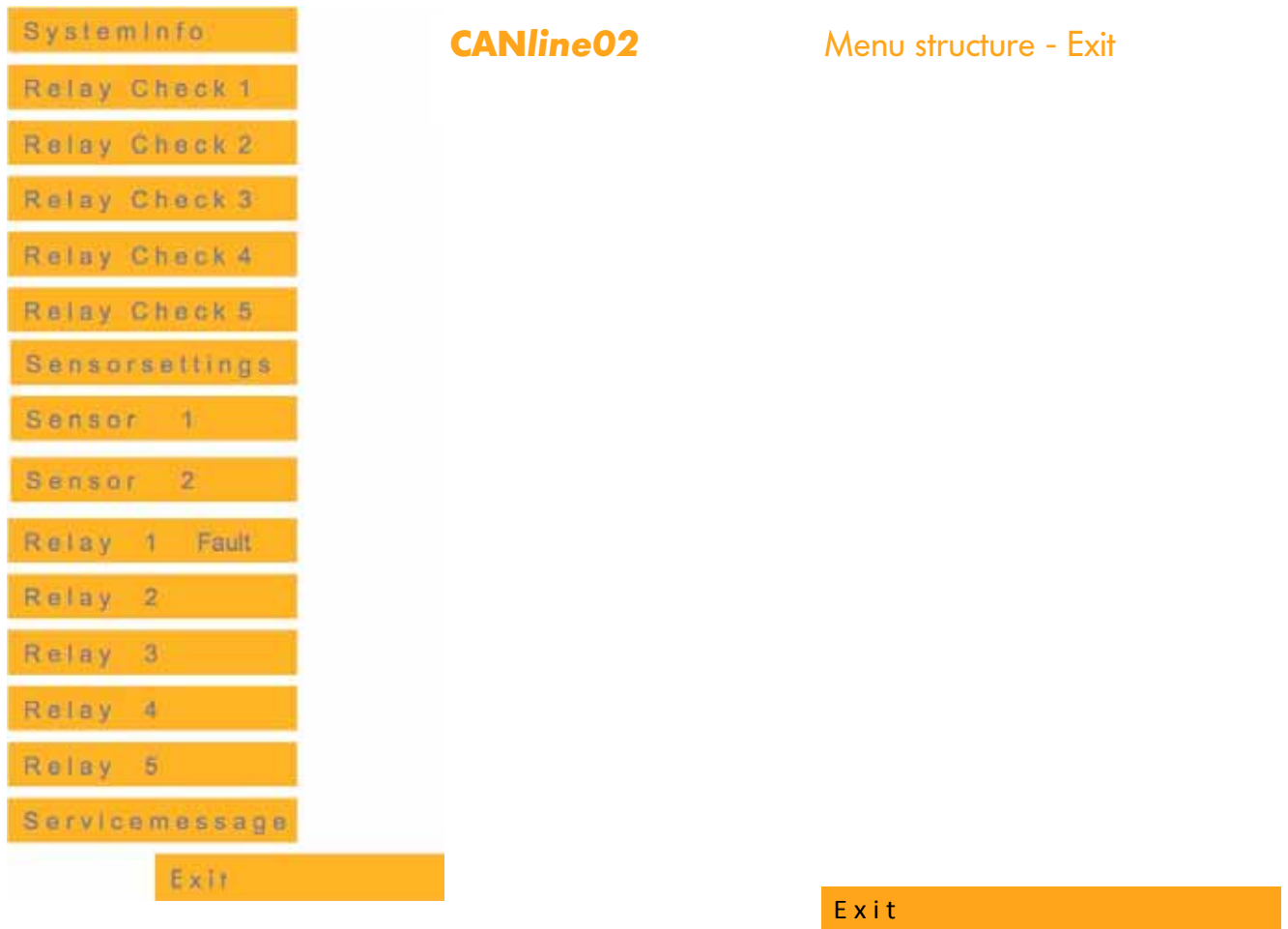

### 8.13 "Normal operation" via "Exit" in the main menu

Likewise, by using the button functions ">", "OK / SELECT" and ">" buttons you can return to the main menu.

## 9 Declaration of Conformity



Rautstrasse 12  
CH-8047 Zuerich, Switzerland

Phone +41 (0)44 404 38 38  
Fax +41 (0)44 404 38 39

Website [www.kimessa.com](http://www.kimessa.com)  
E-mail [info@kimessa.com](mailto:info@kimessa.com)

VAT No. 236061

### EG-Konformitätserklärung EC Declaration of Conformity

Hersteller:  
*Manufacturer:* KIMESSA AG

Anschrift:  
*Address:* Rautstrasse 12  
CH - 8047 Zürich

Produktbezeichnung:  
*Productdescription:* **Zentrale CANline 02, Zentrale CANline 04,  
Zentrale CANline 10, Zentrale CANline 32+,**  
Gas monitor CANline 02, CANline 04,  
Gas monitor CANline 10, CANline 32+,

**Das bezeichnete Produkt stimmt in der von uns in Verkehr gebrachten Ausführung mit den Vorschriften folgender Europäischer Richtlinien überein:**  
*The product described above in the form as delivered is in conformity with the provisions of the following European Directives:*

89/336/EWG Richtlinie des Rates zur Angleichung der Rechtsvorschriften der Mitgliedstaaten über die elektromagnetische Verträglichkeit  
(geändert durch 91/263/EWG, 92/31/EWG, 93/68/EWG und 93/97/EWG).  
*Council Directive on the approximation of the laws of the Member States relating to electromagnetic compatibility (amended by 91/263/EEC, 92/31/EEC, 93/68/EEC and 93/97/EEC)*

Die Konformität mit den Richtlinien wird nachgewiesen durch die Einhaltung folgender Normen:  
*Conformity to the Directives is assured through the application of the following standards:*

Referenznummer <i>Reference number</i>	Ausgabedatum <i>Edition</i>
EN 50270	2006
EN 61326-1	2006

CH - Zürich, den 01.04.2015

Hr Michael Baumann  
Prokurist



mit den genannten Richtlinien, ist jedoch keine Zusicherung von Eigenschaften.  
Die Sicherheitshinweise der mitgelieferten Produktdokumentation sind zu beachten.  
*This declaration certifies the conformity to the specified directives but contains no assurance of properties. The safety documentation accompanying the product shall be considered in detail.*