

Dual Port Differential Manometer

Model: SDMN5

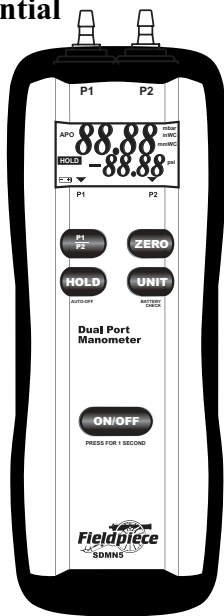

OPERATOR'S MANUAL

General

Accuracy: Stated accuracy at 0 to 50°C (32 to 122°F): ±1.5% FS

Battery: Single standard 9-volt battery, NEDA 1604, JIS 006P, IEC 6F22.

Battery Life: 200 hours with low battery indicator on display.

Operating environment:

32°F (0°C) to 122°F (50°C)

Compatible Media: Dry, non-corrosive gases

Overrange: "OL" or "-OL" is displayed.

Auto-Off power: 15 minutes

Low Battery:  symbol is displayed.

Dimensions: 180mm(~7 1/16")(H) x 60mm(~2 3/8")(W) x 30mm(~1 3/16")(D)

Weight: approximately 195g including battery

Pressure

Pressure Ports: tube connectors for 5mm (~3/16 inch) I.D. flexible tubing

Units of Measure: inWC, mmWC, mbar, PSI

Resolution: 0.01 inch WC

Accuracy/Ranges:

inWC: ±0.02 on 0.00 to ±2.00

±1.5% FS on 2.00 to ±60.0

mmWC: ±0.5 on 0.00 to ±51.0

±1.5% FS on 51.0 to ±1500

mbar: ±0.05 on 0.00 to ±5.00

±1.5% FS on 5.00 to ±150.0

psi: ±0.001 on 0.000 to ±0.07

±1.5% FS on 0.07 to ±2.000

Description

The SDMN5 is a portable standalone dual port manometer. The SDMN5 is capable of taking gas pressure as well as static pressure. The SDMN5 comes in a rugged rubber boot. The SDMN5 also has a zero adjust and a hold button to hold the currently displayed reading. The auto-power-off function conserves battery life, but can be disabled if desired.

The SDMN5 will allow you to take gas pressure up to ±60" (152cm) of WC. The SDMN5 will take differential pressure readings and display the difference between P1 and P2 at all times in the lower right corner of the LCD. The SDMN5 also has four different measurement scales including inches of water column, millimeters of water column, mBar and PSI. Static pressure is possible with the resolution to 0.01" of WC (0.1mmWC). Special purpose static pressure instruments are on the market with better accuracy and temperature compensation but they typically cost many times more than the SDMN5.

Operation

1. Zero SDMN5 by pressing the ZERO just before taking the pressure readings, while at ambient pressure. This will zero both P1 and P2. For measurements less than 2inWC, take reading within 1 minute after zeroing for best accuracy.
2. Connect a single hose to get the gauge pressure relative to the ambient or ZERO pressure.
3. Connect both hoses if you want to see relative pressure, P1 minus P2.
4. By pressing the P1 / P2 button you can change between displaying P1 or P2, P1 - P2 is constantly displayed in the lower right of the LCD.
5. Pressing the unit button makes it possible to switch between the four measurement scales of inches of water column (inWC), millimeters of water column (mmWC), mBar, and PSI. The scale being viewed is displayed on the right side of the LCD.
6. To disable the auto-power-off hold the HOLD button while turning the unit on. If the auto-power-off is enabled (meter will turn off automatically) an APO will appear on the display. If Auto-power-off is disabled (meter will not turn off on its own), then no designation will appear on the LCD.
7. If you are in an environment where the temperature is noticeably changing while you are taking your reading, it is advised that you disconnect the meter from the hoses and ZERO it relative

to ambient before each reading.

Checking Gas Pressure on a Regulator

1. Screw the brass fitting into the pressure port on the regulator.
2. Put unit into operation (i.e. turn on the furnace and have furnace ignite, as if running it in normal operation.)
3. This will give you the pressure coming out of the regulator.
4. If you suspect high or low inlet pressure into the regulator, the manometer can hook into the inlet port in the same manner it can connect into the outlet port. If you have a dual-port manometer, you can check both the inlet and the outlet simultaneously and see the pressure drop across the regulator.
5. See manufacturer's specification for target inlet and outlet pressure for a given regulator or piece of combustion equipment.

Battery Check Function

Press and hold the UNIT button to display the percentage of usable battery remaining. This function can be used any time the meter on.

Field Calibration

Pressure:

By pressing the ZERO button, both the P1 and P2 are zeroed to the pressure they are being exposed to. For this reason the calibration should be done when both P1 and P2 are disconnected from the hoses.

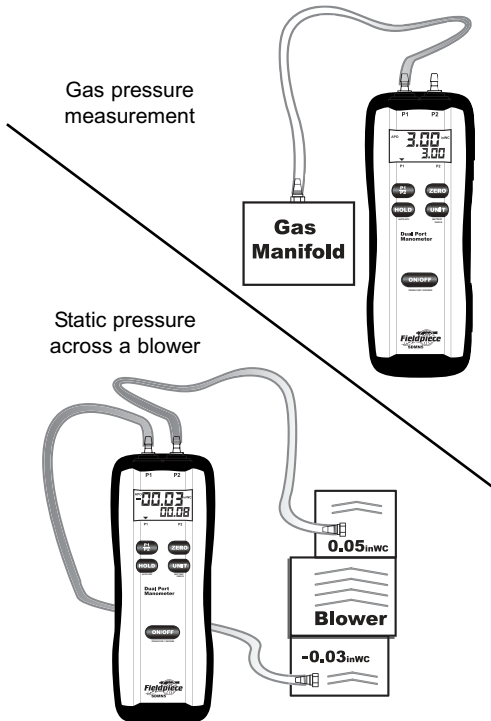

RMA316 Manometer Adapter

Used for 5/16" pressure outlet ports.

1. Shut off main gas supply to furnace.
2. Move the gas valve switch to "OFF" position.
3. Use a 3/32" hex wrench to loosen the outlet pressure tap screw. Rotate screw counter-clockwise one revolution to open.
4. Connect the SDMN5 tubing to the smaller (3/16") end of the adapter and the other (5/16") end of the adapter into the of the adapter tube.
5. Slide the 5/16" adapter tube over the outlet pressure boss (port) to seal. Overlap the pressure boss by at least 3/8" to prevent leakage.

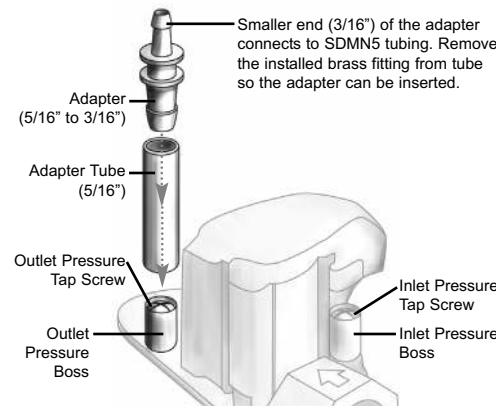

Warranty

The product is warranted to the original purchaser against defects in material or workmanship for a period of one (1) year from the date of purchase. During the warranty period, Fieldpiece Instruments will, at its option, replace or repair the defective unit.

This warranty does not apply to defects resulting from abuse, neglect, accident, unauthorized repair, alteration, or unreasonable use of the instrument. Any implied warranty arising out of the sale of Fieldpiece's products including but not limited to implied warranties of merchantability, and fitness for purpose, are limited to the above. Fieldpiece shall not be liable for incidental or consequential damages.

Service

Return any defective SDMN5 to Fieldpiece for warranty service along with proof of purchase. Contact Fieldpiece for out of warranty repair charges.

Fieldpiece
Designed in USA
MADE IN CHINA

ASP2 Static Pressure Probe

For accurate static pressure measurements.

1. Connect ASP2 to SDMN5 via hose.
2. Insert ASP2 into drilled or pre-existing 1/4" hole.
3. Use alignment arrow on the ASP2 to direct probe into the air stream.
4. Read static pressure measurements from the display on the SDMN5
5. Remove probe and patch hole.

Note: For best accuracy on measurements less than 2inWC, take measurement within 1 minute of zeroing.

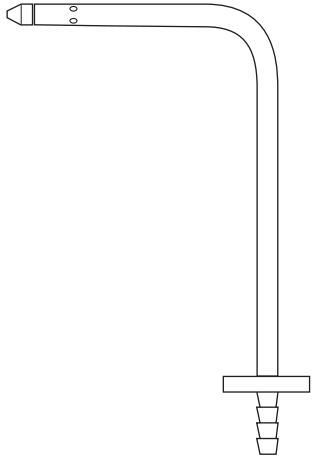

More Products From Fieldpiece

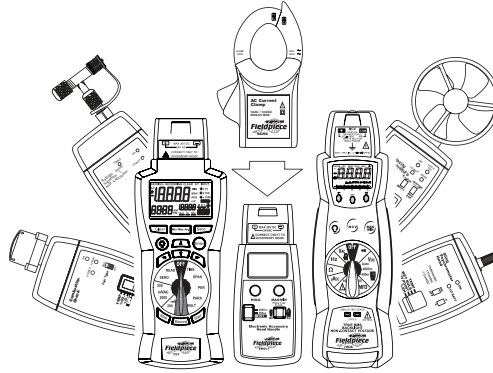

Modular Expandability

Modular expandability is ability for accessory heads and meters to change configurations to match the various needs of an HVAC/R technician.

Accessory heads (the sensors) send out a mV signal, which represents the value of the measurement, to whatever meter is attached to it. Heads can attach directly to the top of a Stick meter, DL3 data logger, or EHDL1. They can also plug into any meter with mV ranges using ASLS2 leads.

Stick Meter

This is the heart of modular expandability. In addition to being a full functioning multimeter, any accessory head can be used with it.

Model HS36

Non contact voltage
Magnetic hanger
Autoranging
Backlight

Temperature
Volts, amps, ohms
Frequency
Microfarads

Includes:
HS36 Meter
ACH4 Current Clamp
ATB1 K-type TCouple
ADLS2 Deluxe Leads
ANC1 Case

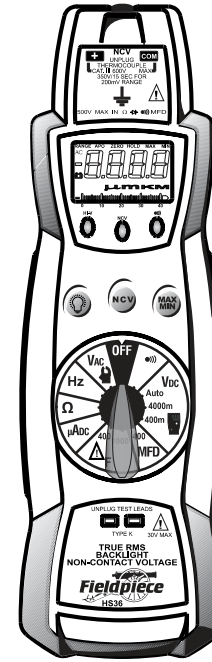

Accessory Heads

Accessory heads are the sensors of multiple parameters measured by technicians every day. They plug into a mV range (depending on the head) of a multimeter. The multimeter will display whatever the head is measuring. Instead of having to purchase and carry a separate instrument for each parameter, a technician can use multiple heads and a single multimeter to do the job.

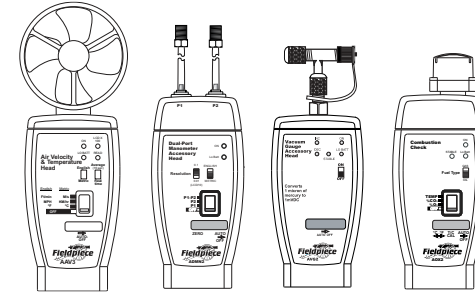

Here are four of the many heads available:

- AAV3 Air Velocity and Temperature
- ADMN2 Dual-Port Manometer
- AVG2 Digital Vacuum Gauge
- AOX2 Combustion Check