



# valbrass

*Top of the Taps!*





L'azienda è il grande motore della società,  
genera opportunità più di qualunque altra istituzione,  
è la base di un mondo economicamente sano.

**JACK WELCH JR. (1935 - )**

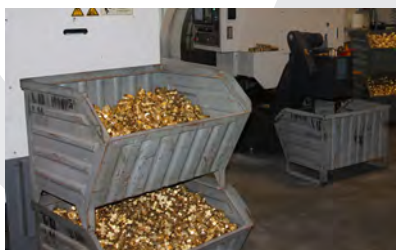
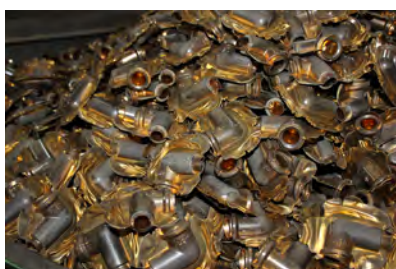

## L'AZIENDA

Le origini della tradizione della famiglia Facchetti nel campo della rubinetteria affondano sin dal 1950, quando la prima generazione iniziò come “artigiano per conto-terzi” per aziende della zona già affermate nel settore.

Grazie allo spirito imprenditoriale della seconda e terza generazione si sviluppano prodotti a proprio marchio e design, che consentiranno di farsi conoscere ed apprezzare nel mondo con capacità tecniche e strumenti all'avanguardia che permettono di dar vita nel 1997 alla VALBRASS, una nuova, giovane e dinamica realtà produttiva di valvolame e raccorderia.

L'azienda è caratterizzata da una direzione familiare, la cui politica è basata sull'attenta selezione dei materiali e sulla scelta dei collaboratori e dei fornitori.

Il personale specializzato segue l'intero ciclo produttivo, dallo stampaggio, alle lavorazioni su macchine transfer e torni a CNC, all'assemblaggio ed imballaggio.

È dedicata particolare attenzione alla qualità dei prodotti mediante accurati controlli con attrezzature certificate e macchinari automatici all'avanguardia.

La produzione spazia dalle valvole di ritegno e di fondo, a sfera e saracinesche tradizionali, raccorderia in ottone ed inox, manometri a secco e con glicerina.

Realizziamo inoltre particolari su disegno o specifica della clientela nei materiali ottone, acciaio AVP, ghisa, inox, bronzo, rame, alluminio, ottenuti sia da stampaggio che da barra.

La gestione degli ordinativi è rapida ed efficace, in grado di accogliere le esigenze del mercato.

Lo staff VALBRASS ha come priorità la soddisfazione del cliente, per un'azienda forte e proiettata nel futuro.

Ringraziamo quanti da tempo sono affezionati clienti e quanti lo diverranno.

Milioni di valvole, raccordi, rubinetti e manometri installati nel corso degli anni in differenti climi e condizioni lavorative in tutto il mondo sono la migliore prova della nostra qualità ed affidabilità.

**È difficile esista qualcosa,  
in questo mondo,  
che qualcuno non possa costruire  
un poco peggio e vendere  
a prezzo un poco inferiore.  
Chi consideri, in ogni cosa,  
solo il prezzo, è, di costui,  
legittima preda.**

**RUSKIN (1819 - 1900)**

## THE COMPANY

The origins of the tradition of Facchetti's family in the field of valves are since year 1950, when the first generation began as "craft on somebody else's behalf" for companies just well-known in this kind of industry.

Thanks to the entrepreneurial spirit of second and third generation, we developed products with our own brand and design, that allow to be known and appreciated across the world by technical abilities, vanguard instruments allow on 1997 to give one's life to **VALBRASS**, a new, young and dynamic productive reality of valves and fittings.

The firm has a domestic management, with a particular attention on the selection of materials, suppliers and collaborators.

The skilled staff follows the entire production cycle, from forging, machining on transfers and CNC lathes, to assembly and packing.

Special attention has given to the quality of products through careful monitoring

with certified equipments and automatic machineries.

The production's range is very wide : check and foot valves, ball valves, gate valves, brass, Stainless Steel and galvanized fittings, pressure gauges and thermometers.

We produce also special items on customer's requirement with the following materials: brass, steel, stainless steel, ductil and cast iron, bronze, copper, aluminium, from forging or bar.

Thanks to short delivery time, we can satisfy the requests of market in the best way.

**VALBRASS'** staff has the customer's satisfaction as its priority, for a company future's projected.

We thanks all the loyal customers and those who will become in future.

Millions of valves, fittings, taps and gauges installed long years in different climates and working conditions in all over the world are the best proof of our quality and reliability.



**Alcune persone vedono un'impresa privata come una tigre feroce da uccidere subito, altri come una mucca da mungere, pochissimi la vedono com'è in realtà: un robusto cavallo che traina un carro molto pesante.**

**WINSTON CHURCHILL (1874 - 1965)**

# L'uomo e l'acqua: il rubinetto nella storia

*Man and water:  
the history of tap*

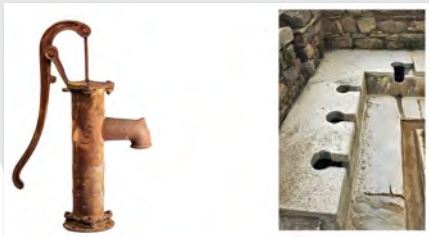

Antica Pompa a Mano –  
Antiche Latrine Pubbliche  
(Ostia Antica / Italia – III°  
secolo a.C.)  
*Ancient Hand Water  
Pump – Ancient Public  
Toilet (Ostia Antica / Italy  
3rd century BC)*



Rubinetti e Tubi Romani  
(Aquileia / Italia – II° se-  
colo a.C.)  
*Roman Taps and Pipes  
(Aquileia / Italy – 2nd  
century BC)*



Vecchio Rubinetto a  
Galleggiante (Brescia /  
Italia – XVII° secolo)  
*Old Float Valve (Brescia /  
Italy – 17th century)*



Antica Pompa Idraulica  
(Aquincum / Budapest /  
Ungheria – I° secolo a.C.)  
*Ancient Hydraulic Pump  
(Aquincum / Budapest /  
Hungary – 1st century BC)*



Valvola di Bronzo roma-  
na (Pompei / Italia – V°  
secolo a.C.)  
*Bronze Roman Valve  
(Pompei / Italy – 5th  
century BC)*



Vite di Archimede dal  
Codice Atlantico / Codex  
Atlanticus (Leonardo Da  
Vinci – Milano / Italia –  
1478-1518)  
*Archimedes Screw from  
Atlantic Codex (Leonardo  
da Vinci's – Milan / Italy  
– 1478-1518)*

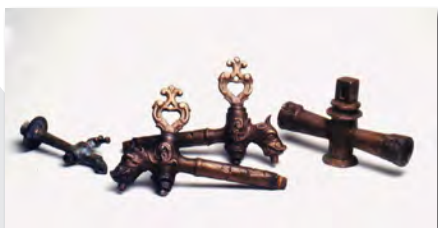

Rubinetti Antichi (Firenze  
/ Italia – IV° secolo)  
*Antique Taps (Florence /  
Italy – 4th century)*

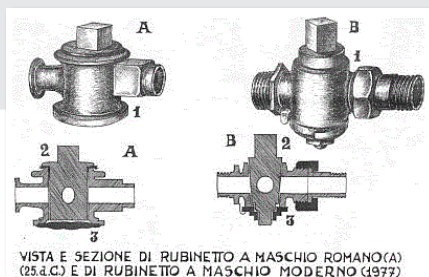

Valvola nella Storia  
(Novara / Italia – I° e XX°  
secolo)  
*Valve in the history (No-  
vara / Italy – 1st and 20th  
century)*



Rubinetti Greci e Sistemi  
Idraulici (Atene / Grecia –  
II° secolo)  
*Greek Taps and Hydraulic  
Systems (Athens / Gree-  
ce – 2nd century)*



Rubinetto d'epoca  
Rinascimentale  
(Venezia / Italia  
XV secolo)  
*Renaissance Tap  
(Venice / Italy  
15th century)*



Acquedotto e Ponte Romano / Pont du Gard (Francia - 19 a.C.)  
*Roman Aqueduct and Bridge / Pont du Gard (France - 19 BC)*



Diga di Cornalvo / Presa romana (Mérida / Spagna - I°-II° secolo) - Ancora in uso  
*Cornalvo Dam (Mérida / Spain - 1st-2nd century) - Still in use*



Canale di Corinto (Corinto / Grecia - 1881-1893)  
*Corinth Canal (Corinth / Greece - 1881-1893)*



Noria a Secchi (Hama / Siria - 200 a.C.)  
*Water Wheel (Hama / Syria - 200 BC)*



Terme romane di Bath (Aeque Sulis / Bath / Inghilterra - 75 d.C.)  
*Roman Baths (Aeque Sulis / Bath / England - 75)*



Acquedotto Navigabile / Kanalbrücke Magdeburg (Magdeburg / Germania - 1997-2003)  
*Magdeburg Water Bridge (Magdeburg / Germany - 1997-2003)*



Fontane nei Giardini della Reggia di Peterhof (San Pietroburgo / Russia - XVIII° secolo)  
*Fountains in Peterhof Palace Complex Gardens (St. Petersburg / Russia - 18th century)*

**Il miracolo economico non è stato prodotto da imprese socializzate, da cartelli governo-sindacati o dalla pianificazione economica centralizzata. È stato prodotto da imprese private in un sistema di profitti e perdite**

**MILTON FRIEDMAN (1912 - 2006)**

CERTIFICAZIONI/Certification



## INDICE/Index

Valvole a sfera..... p.3 <i>Ball valves</i>	Contatori..... p.144 <i>Water Meters</i>
Valvole a sfera per gas..... p.26 <i>Gas ball valves</i>	Accessori per serbatoi..... p.145 <i>Accessories for tanks</i>
Valvole di ritegno..... p.30 <i>Check valves</i>	Pneumatica..... p.146 <i>Pneumatics</i>
Valvole di fondo..... p.36 <i>Foot valves</i>	Acciaio Inox..... p.156 <i>Stainless steel</i>
Idraulica..... p.39 <i>Hydraulics</i>	Valvole a sfera con attuatore p.173 <i>Ball valves with actuator</i>
Galleggianti..... p.57 <i>Float valves</i>	Raccorderia in ghisa malleabile... p.174 <i>Malleable cast iron fittings</i>
Portamanometri e manometri..... p.61 <i>Manometers - holders</i>	Raccorderia nera..... p.192 <i>Black fittings</i>
Rubinetti bagno..... p.70 <i>Bathroom bibcocks</i>	Tronchetti e barilotti..... p.194 <i>Stub ends and extensions</i>
Flessibili - estensibili..... p.80 <i>Flexibles - extensibles</i>	Raccorderia in acciaio zincato.... p.196 <i>Galvanized steel fittings</i>
Rubinetti..... p.91 <i>Bibcocks</i>	Valvole a farfalla..... p.200 <i>Butterfly valves</i>
Raccordi per tubo polietilene..... p.100 <i>Polyethylene pipe connectors</i>	Valvole industriali..... p.205 <i>Industrial valves</i>
Raccordi girevoli..... p.105 <i>Swivel connectors</i>	Giunti..... p.210 <i>Joints</i>
Raccordi..... p.107 <i>Fittings</i>	Flange..... p.212 <i>Flanges</i>
Raccorderia nautica..... p.135 <i>Nautical fittings</i>	Accessori..... p.216 <i>Accessories</i>
Irrigazione..... p.136 <i>Irrigation</i>	Ricambi..... p.220 <i>Spare parts</i>
Collettori ..... p.141 <i>Manifolds</i>	<b>Indice analitico..... p.222</b> <b>Index</b>

Il peggior crimine contro la classe lavoratrice  
è un'azienda che manca di operare con profitto.

**SAMUEL GOMPERS (1850 - 1924)**



## VALVOLE A SFERA A PASSAGGIO RIDOTTO PN25 (5 filetti)

*Ball valves reduced bore (5 threads)*



**Art.470**

Valvola a sfera F.F. Passaggio Ridotto

*Ball valve F.F. Reduced Bore*



Maniglia in acciaio cromato  
con rivestimento in gomma rossa  
*With handle in chromium plated steel  
red rubber covered*

Misura / A	DN	W	C	D	gr.		
1/2"	10	24	50	42	143	12	192
3/4"	14	30	50	42	180	12	120
1"	18	37	57	54	264	12	96
1.1/4"	24	46	65	62	430	6	48
1.1/2"	32	53	77	70	628	4	32
2"	40	65	91	84	998	2	24
2.1/2"	50	82	112	90	1840	2	16
3"	58	94	127	95	2804	1	8
4"	68	121	137	95	4191	1	6

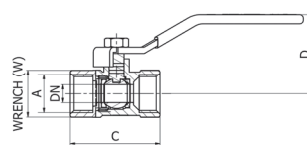



**Art.471**

Valvola a sfera F.F. Passaggio Ridotto

*Ball valve F.F. Reduced Bore*



Con farfalla rossa  
*With red "T" handle*

Misura / A	DN	W	C	D	gr.		
1/2"	10	24	50	32	116	12	192
3/4"	14	30	50	32	153	12	120
1"	18	37	57	44	241	12	96

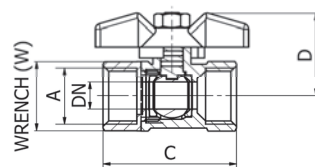

### Caratteristiche tecniche *Technical features*

Corpo e sfera : Ottone CW617N UNI EN 12165

Asta e premistoppa : Ottone CW614N UNI EN 12164

Sfera lavorata con utensile al diamante e cromata a spessore

Sedi in P.T.F.E. vergine

Guarnizioni di tenuta asta : 2 O-Rings in NBR

Finitura superficiale sabbata e nichelata

Maniglia : disponibile in acciaio cromato

rivestito in gomma (rossa) o farfalla in alluminio (rossa)

Temperatura di esercizio : -20° C / +90° C

Filettature : ISO 228

*Body and Ball : Brass CW617N UNI EN 12165*

*Stem and stuffing box : Brass CW614N UNI EN 12164*

*Ball diamond machined and chromed*

*Seats in P.T.F.E., stem with 2 O-Rings in NBR*

*Surface sand blasted and nickel plated*

*Handle : available in chromium plated steel rubber covered (red) or wing aluminium handle (red)*

*Working temperatures : -20° C / +90° C*

*Threads : ISO 228*

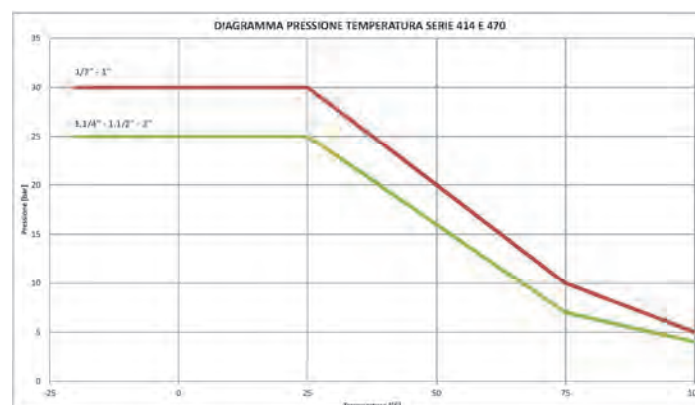

## VALVOLE A SFERA A PASSAGGIO TOTALE "STANDARD" PN30 (5 filetti)

*Ball valves full bore "Standard" type (5 threads)*

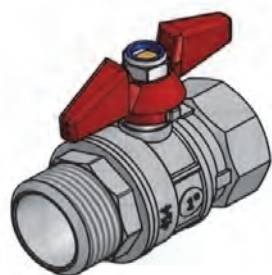
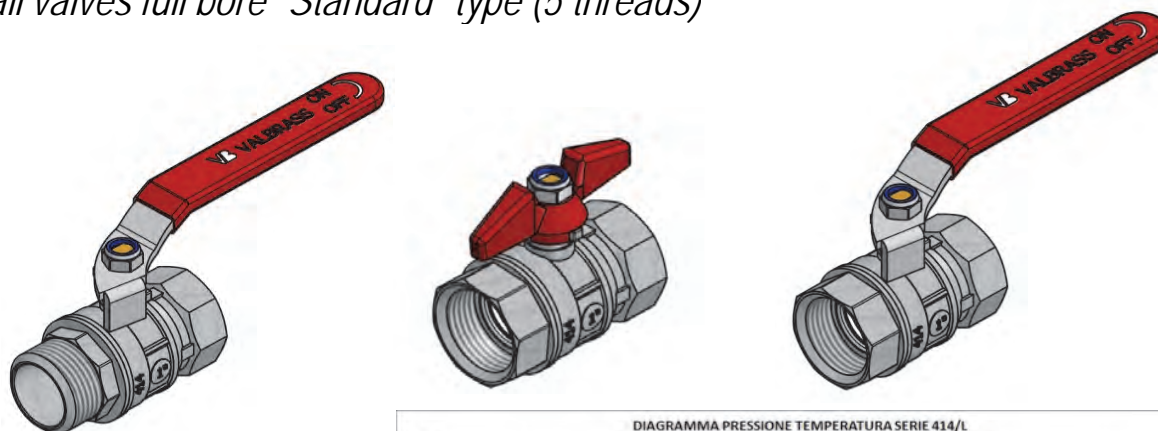

### Caratteristiche tecniche *Technical features*

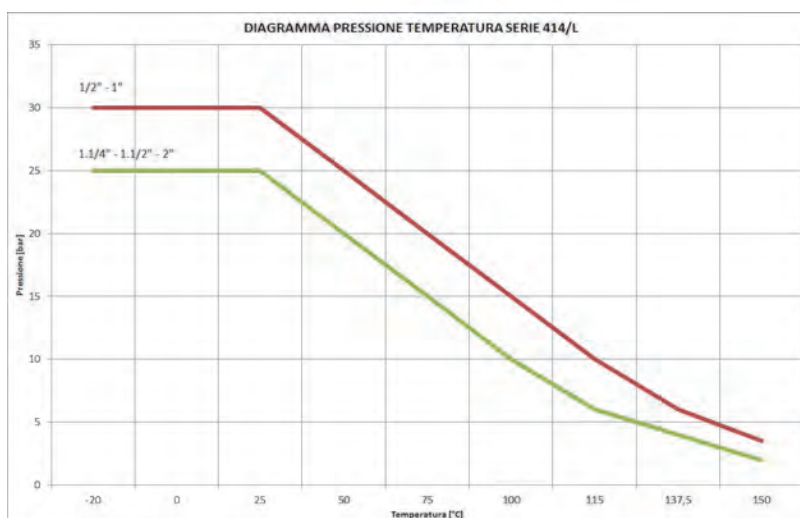



Corpo e sfera : Ottone CW617N UNI EN 12165  
 Asta e **premistoppa** : Ottone CW614N UNI EN 12164  
 Sfera lavorata con utensile al diamante e cromata a spessore  
 Sedi sfera in P.T.F.E. vergine  
**Sede asta : PTFE**  
 Finitura superficiale sabbata e nichelata  
 Maniglia : disponibile in acciaio cromato rivestito in gomma (rossa)  
                   o alluminio (farfalla rossa o maniglia lunga nera)  
 Temperatura di esercizio : -20° C / +180° C  
 Filettature : ISO 228

*Body and Ball : Brass CW617N UNI EN 12165*  
*Stem and **stuffing box** : Brass CW614N UNI EN 12164*  
*Ball diamond machined and chromed*  
*Seats in P.T.F.E., **Seat stem : PTFE***  
*Surface sand blasted and nickel plated*  
*Handle : available in chromed steel rubber covered (red)*  
                   *or aluminium (red wing handle or long black handle)*  
*Working temperatures : -20° C / +180° C*  
*Threads : ISO 228*

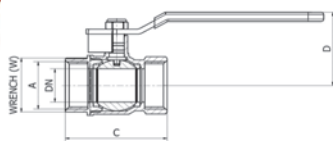
**Art.414/L** Valvola a sfera F.F.

*Fullway ball valve F.F.*



Misura / A	DN	W	C	gr.		
1/2"	13,5	25	48	149	18	180
3/4"	17,5	30	54	201	12	120
1"	23	37	66	327	8	80
1.1/4"	30	46	74	507	4	40
1.1/2"	37	53	86	771	4	40
2"	45	64	96,5	1012	4	24

Maniglia in acciaio cromato  
con rivestimento in gomma rossa

*With handle in chromium plated steel  
red rubber covered*

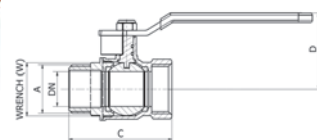
**Art.428/L** Valvola a sfera F.F.

*Fullway ball valve F.F.*



Misura / A	DN	W	C	gr.		
1/2"	13,5	25	54	157	18	180
3/4"	17,5	30	60	212	12	120
1"	23	37	70	335	8	80
1.1/4"	30	46	83	538	4	40
1.1/2"	37	53	94	807	4	24
2"	45	64	104	1066	4	24

Maniglia in acciaio cromato  
con rivestimento in gomma rossa

*With handle in chromium plated steel  
red rubber covered*

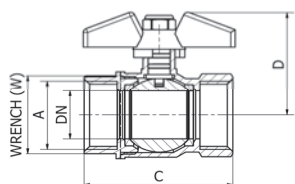
**Art.427/L** Valvola a sfera F.F.

*Fullway ball valve F.F.*



Misura / A	DN	W	C	gr.		
1/2"	13,5	25	48	127	18	180
3/4"	17,5	30	54	176	12	120
1"	23	37	66	297	8	80

Con farfalla rossa

*With red "T" handle*

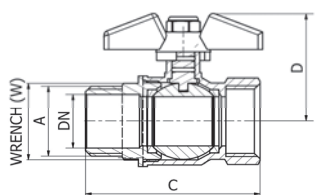
**Art.429/L** Valvola a sfera M.F.

*Fullway ball valve M.F.*

Misura / A	DN	W	C	gr.		
1/2"	13,5	25	54	133	18	180
3/4"	17,5	30	60	188	12	120
1"	23	37	70	306	8	80

Con farfalla rossa

*With red "T" handle*

## VALVOLE A SFERA A PASSAGGIO TOTALE "STANDARD" PN30 (5 filetti)

*Ball valves full bore "Standard" type (5 threads)*

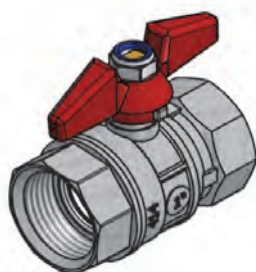
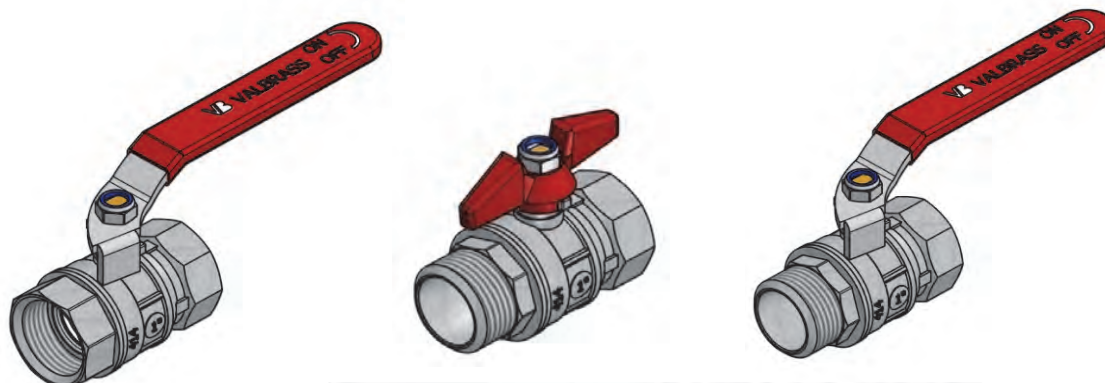

### Caratteristiche tecniche *Technical features*

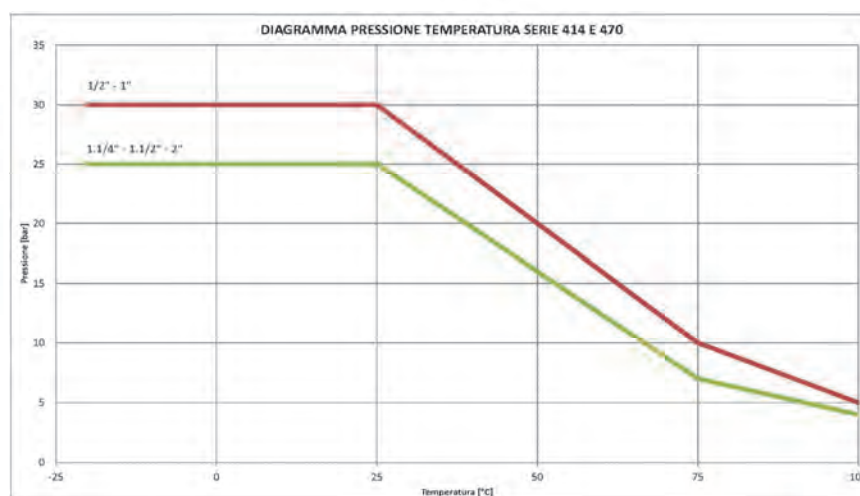

Corpo e sfera : Ottone CW617N UNI EN 12165  
 Asta : Ottone CW614N UNI EN 12164  
 Sfera lavorata con utensile al diamante e cromata a spessore  
 Sedi in P.T.F.E. vergine  
**Guarnizioni di tenuta asta : 2 O-Rings in NBR**  
 Finitura superficiale sabbata e nichelata  
 Maniglia : disponibile in acciaio cromato rivestito in gomma (rossa)  
                   o alluminio (farfalla rossa o maniglia lunga nera)  
 Temperatura di esercizio : -20° C / +90° C  
 Filettature : ISO 228



*Body and Ball : Brass CW617N UNI EN 12165*  
*Stem : Brass CW614N UNI EN 12164*  
*Ball diamond machined and chromed*  
*Seats in P.T.F.E., stem with 2 O-Rings in NBR*  
*Surface sand blasted and nickel plated*  
*Handle : available in chromed steel rubber covered (red), stainless steel AISI 304*  
                   *rubber covered (blue), or aluminium (red wing handle or long black handle)*  
*Working temperatures : -20° C / +90° C*  
*Threads : ISO 228*

**Art.414** Valvola a sfera F.F.

*Fullway ball valve F.F.*



Maniglia in acciaio cromato  
con rivestimento in gomma rossa

*With handle in chromium plated steel  
red rubber covered*

Misura / A	DN	W	C	D	gr.		
1/2"	14	26	53	43	177	12	144
3/4"	19	31	56	52	232	12	120
1"	24	38	68	61	380	6	60
1.1/4"	30	47	76	73	570	4	40
1.1/2"	37	54	89	77	805	4	24
2"	48	66	101	93	1350	2	16
2.1/2"	64	83	131	126	2825	1	8
3"	73	96	153	133	3905	1	6
4"	90	125	170	143	6540	1	4

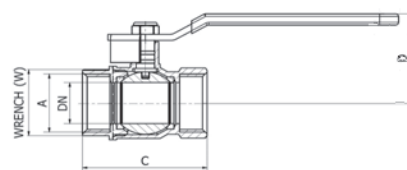

**Art.414/N** Con maniglia in alluminio nera  
*With Black aluminium handle*



**Art.414/B** Con maniglia in acciaio cromato rivestita in gomma blu  
*With chromium plated steel handle blu rubber covered*





**Art.414/Y** Disponibile con corpo giallo  
*Available also with yellow body*

**Art.428** Valvola a sfera M.F.

*Fullway ball valve M.F.*



Maniglia in acciaio cromato  
con rivestimento in gomma rossa

*With handle in chromium plated steel  
red rubber covered*

Misura / A	DN	W	C	D	gr.		
1/2"	14	21	61	43	181	12	120
3/4"	19	28	64	52	240	12	120
1"	24	34	76	61	392	6	60
1.1/4"	30	43	82	73	590	4	40
1.1/2"	37	49	95	77	780	4	24
2"	48	62	110	93	1410	2	16
2.1/2"	64	83	144	126	2968	1	8
3"	73	96	159	133	4075	1	6
4"	90	121	187	143	6360	1	4

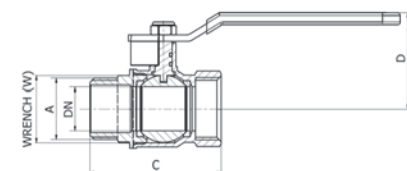

**Art.428/N** Con maniglia in alluminio nera  
*With Black aluminium handle*



**Art.428/B** Con maniglia in acciaio cromato rivestita in gomma blu  
*With chromium plated steel handle blu rubber covered*

**Art.427** Valvola a sfera F.F.

*Fullway ball valve F.F.*

Con farfalla rossa

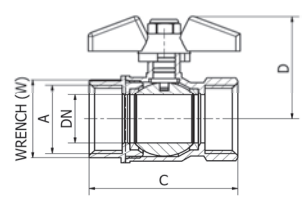

With red "T" handle

Misura / A	DN	W	C	D	gr.		
1/2"	14	26	53	38	140	10	120
3/4"	19	31	56	45	202	10	120
1"	24	38	68	46	353	6	60
1.1/4"	30	47	76	73	540	4	40
1.1/2"	37	54	89	77	795	4	40

**Art.427/MIT**

Misura / A	DN	W	C	D	gr.		
* 1/2"	14	26	53	38	140	10	120

 \* Con O-RINGS in VITON  
 \*With VITON O-RINGS

**Art.427/N** Con farfalla in alluminio nera  
 With black "T" handle

**Art.429** Valvola a sfera M.F.

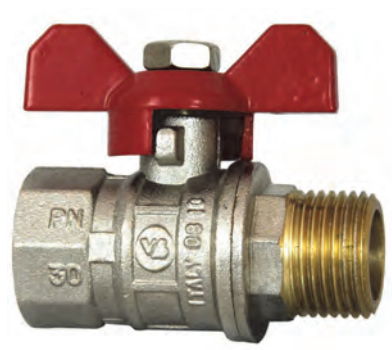
*Fullway ball valve M.F.*

Con farfalla rossa

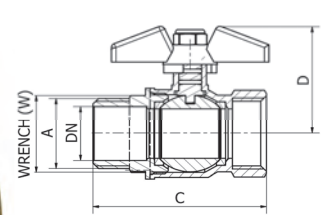

With red "T" handle

Misura / A	DN	W	C	D	gr.		
1/2"	14	21	61	38	148	10	120
3/4"	19	28	64	45	213	10	120
1"	24	34	76	46	352	6	60
1.1/4"	30	43	82	73	590	4	40
1.1/2"	37	49	95		780	4	24



**Art.429/N** Con farfalla in alluminio nera  
 With black "T" handle

## VALVOLE A SFERA A PASSAGGIO TOTALE, SERIE PESANTE PN40 ( 7 filetti)

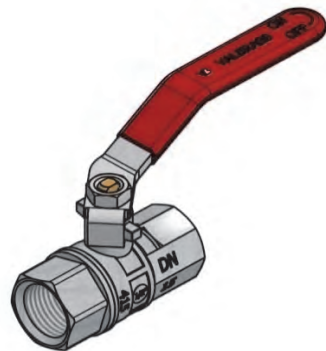
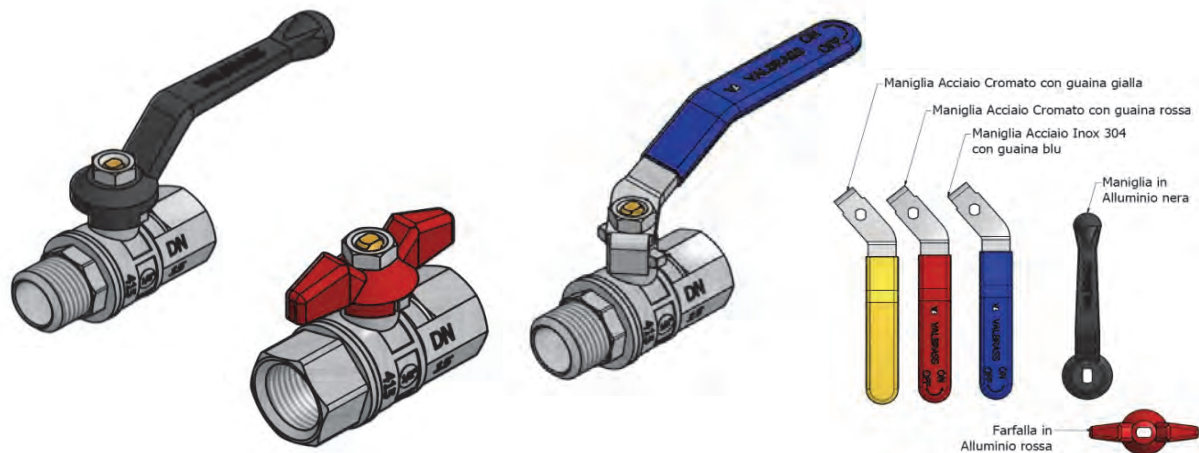
*Ball valves full bore, Heavy Type (7 threads)*

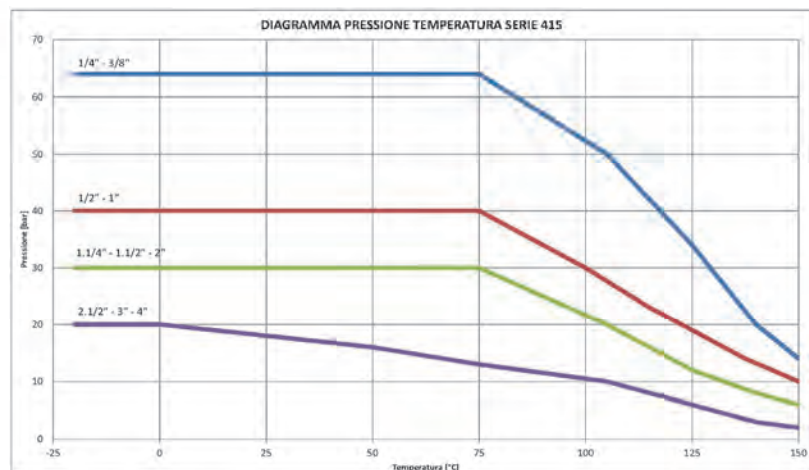

### Caratteristiche tecniche *Technical features*



Corpo e sfera : Ottone CW617N UNI EN 12165  
 Asta e premistoppa : Ottone CW614N UNI EN 12164  
 Sfera lavorata con utensile al diamante e cromata a spessore  
 Sedi in P.T.F.E. vergine  
 Guarnizione di tenuta asta in P.T.F.E.  
 Finitura superficiale sabbiata e nichelata  
 Maniglia : disponibile in acciaio cromato rivestito in gomma (rossa), acciaio INOX AISI 304 rivestito in gomma (blu), o alluminio (farfalla rossa o maniglia lunga nera)  
 Temperatura di esercizio : -20° C / +180° C  
 Filettature : ISO 228

*Body and Ball : Brass CW617N UNI EN 12165*  
*Stem and stuffing box : Brass CW614N UNI EN 12164*  
*Ball diamond machined and chromed*  
*Seats and stem's gaskets in pure P. T.F.E.*  
*Surface sand blasted and nickel plated*  
*Handle : available in chromed steel rubber covered (red), stainless steel AISI 304 rubber covered (blue), or aluminium (red wing handle or long black handle)*  
*Working temperatures : -20° C / +180° C*  
*Threads : ISO 228*

**Art.415** Valvola a sfera F.F. passaggio Totale

Fullway ball valve F.F.

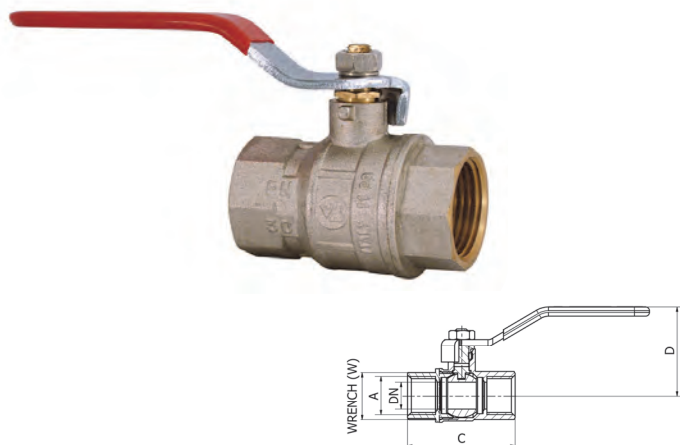

Misura / A	DN	W	C	D	gr.		
1/4"	10	21	46	38	146	12	192
3/8"	10	21	46	42	132	12	192
1/2"	15	25	58	50	188	12	120
3/4"	20	31	64	54	309	12	96
1"	25	38	70	61	426	6	60
1.1/4"	32	47	82	74	658	4	32
1.1/2"	40	54	94	80	910	4	24
2"	50	66	109	89	1477	2	16
2.1/2"	64	83	131	126	2825	1	8
3"	73	96	153	133	3905	1	6
4"	90	125	170	143	6540	1	4
5"			230	180		1	1
6"			235	180		1	1

**Art.416** Con maniglia in alluminio nera  
 With Black aluminium handle

**Art.415/B** Con maniglia in acciaio cromato rivestita in gomma blu  
 With chromium plated steel handle blu rubber covered

**Art.421** Valvola a sfera M.F. passaggio Totale

Fullway ball valve M.F.

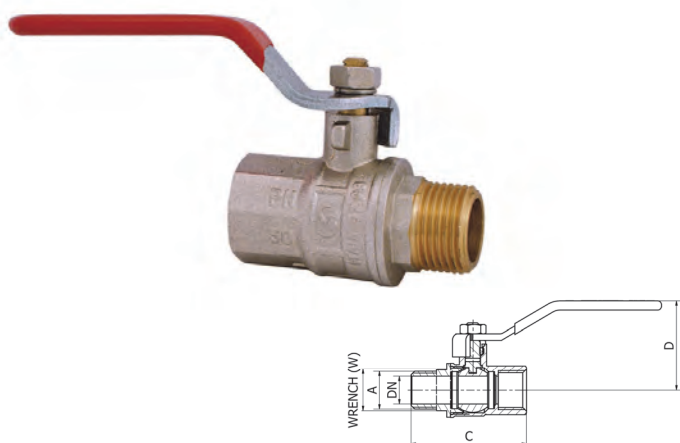

Misura / A	DN	W	C	D	gr.		
1/4"	10	16	50	38	136	12	192
3/8"	10	16	50	42	133	12	192
1/2"	15	21	62	50	183	12	120
3/4"	20	28	68	54	308	12	96
1"	25	34	79	61	443	6	60
1.1/4"	32	47	87	74	698	4	32
1.1/2"	40	49	101	80	918	4	24
2"	50	62	115	89	1549	2	16
2.1/2"	64	83	144	126	2968	1	8
3"	73	96	159	133	4075	1	6
4"	90	121	187	143	6360	1	4

**Art.418** Con maniglia in alluminio nera  
 With Black aluminium handle

**Art.421/B** Con maniglia in acciaio cromato rivestita in gomma blu  
 With chromium plated steel handle blu rubber covered

**Art.415/LO** Valvola a sfera F.F., maniglia lucchettabile

 Fullway ball valve F.F., **lockable's handle**

Misura / A	DN	gr.		
1/4"	10		12	192
3/8"	10		12	192
1/2"	15		12	120
3/4"	20		12	96
1"	25		6	48
1.1/4"	32		4	32
1.1/2"	40		4	24
2"	50		2	16

 Maniglia in acciaio cromato  
 con rivestimento in gomma rossa

 With handle in chromium plated steel  
 red rubber covered



**Art.421/LO** Valvola a sfera M.F., maniglia lucchettabile *Fullway ball valve M.F., lockable's handle*

Maniglia in acciaio cromato  
con rivestimento in gomma rossa

*With handle in chromium plated steel  
red rubber covered*

Misura / A	DN		
1/4"	10	12	192
3/8"	10	12	192
1/2"	15	12	120
3/4"	20	12	96
1"	25	6	48
1.1/4"	32	4	32
1.1/2"	40	4	24
2"	50	2	16

**Art.420** Valvola a sfera F.F. passaggio Totale

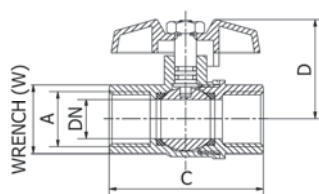
*Fullway ball valve F.F.*

Misura / A	DN	W	C	D	gr.		
1/4"	10	21	46	33	118	12	192
3/8"	10	21	46	33	104	12	192
1/2"	15	25	58	38	156	12	120
3/4"	20	31	64	46	286	12	96
1"	25	38	70	53	379	6	60
1.1/4"	32	47	82	74	620	4	32
1.1/2"	40	49	101	80	900	4	32

**Art.420/N** Con farfalla in alluminio nera  
*With black "T" handle*
**Art.422** Valvola a sfera M.F. passaggio Totale

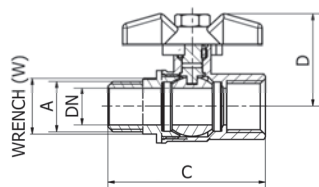
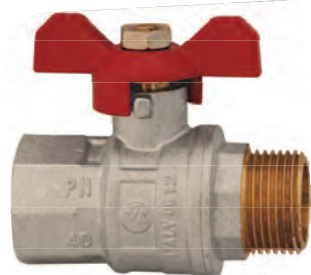
*Fullway ball valve M.F.*

Misura / A	DN	W	C	D	gr.		
1/4"	10	16	50	33	111	12	192
3/8"	10	16	50	33	108	12	192
1/2"	15	21	62	38	157	12	120
3/4"	20	28	68	46	279	12	96
1"	25	34	79	53	396	6	60
1.1/4"	32	47	87	66	634	4	32

**Art.422/N** Con farfalla in alluminio nera  
*With black "T" handle*
**Art.416/E** Valvola a sfera F.F. con asta prolungata

*Fullway ball valve F.F. with extension*



Misura / A		
1/2"	6	60
3/4"	8	64
1"	4	40
1.1/4"	4	24
1.1/2"	4	24
2"	2	12
2.1/2"	1	1
3"	1	1
4"	1	1

**Art.416/PE** Kit prolunga valvole Artt.416-418-414/N-428/N *Extension kit for valves Artt.416-418-414/N-428/N*

Misura / A		
1/2"	1	1
3/4"	1	1
1"	1	1
1.1/4"	1	1
1.1/2"	1	1
2"	1	1
2.1/2" - 3" - 4"	1	1

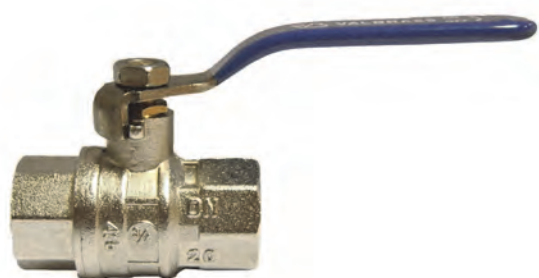

Applicabili alle valvole serie 416-418 (e similari) ed Art.414/N-428/N (e similari)

**Art.417** Valvola a sfera F.F. leva ACCIAIO INOX *Fullway ball valve F.F. , STAINLESS STEEL handle*

Misura / A	DN		
1/4"	8	12	192
3/8"	10	12	192
1/2"	15	12	144
3/4"	20	12	96
1"	25	6	60
1.1/4"	32	4	40
1.1/2"	40	4	20
2"	50	2	16

Maniglia e dado in ACCIAIO INOX

STAINLESS STEEL handle and nut

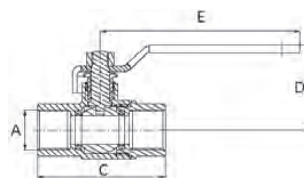
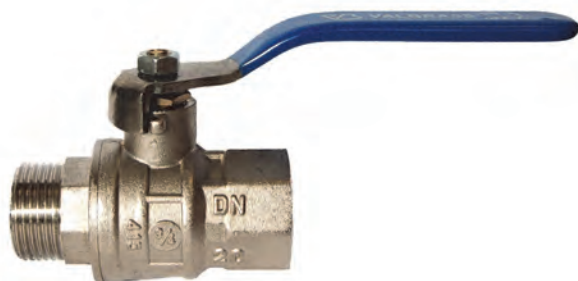
**Art.419** Valvola a sfera M.F. leva ACCIAIO INOX *Fullway ball valve M.F. , STAINLESS STEEL handle*

Misura / A	DN		
1/4"	8	12	192
3/8"	10	12	192
1/2"	15	12	120
3/4"	20	12	96
1"	25	6	60
1.1/4"	32	4	40
1.1/2"	40	4	20
2"	50	2	16

Maniglia e dado in ACCIAIO INOX

STAINLESS STEEL handle and nut

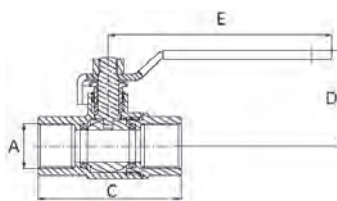

## VALVOLE A SFERA CON RITEGNO INCORPORATO

Modello Pesante 7 filetti

*Ball valves full bore with check valve built-in, Heavy Type (7 threads)*

**Art.1700** Valvola F.F. con ritegno incorporato

*Fullway ball valve F.F. with check valve built-in*

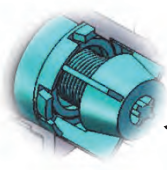
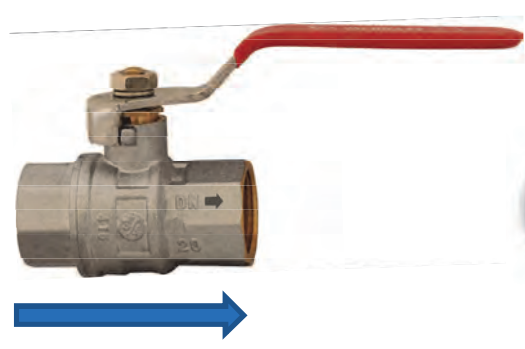

Misura / A	DN	W	C	D	gr.		
1/2"	15	25	58	50	200	12	120
3/4"	20	31	64	54	330	15	60
1"	25	38	70	61	450	10	40
1.1/2"	40	54	94	80	970	4	24
2"	50	66	109	89	1530	2	16

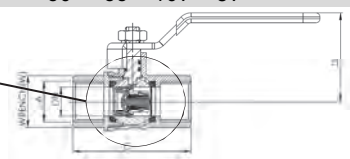

**Art.1705** Valvola F.F. con ritegno incorporato

*Fullway ball valve F.F. with check valve built-in*

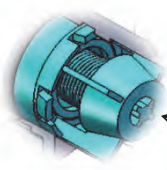
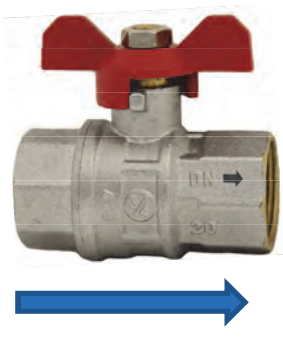

Misura / A	DN	W	C	D	gr.		
1/2"	15	25	58	38	165	12	120
3/4"	20	31	64	46	300	12	96
1"	25	38	70	53	495	12	48

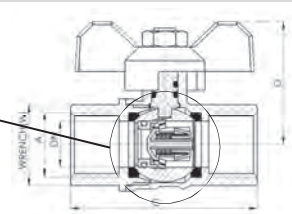

**Art.1710** Valvola M.F. con ritegno incorporato

*Fullway ball valve M.F. with check valve built-in*

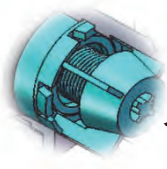
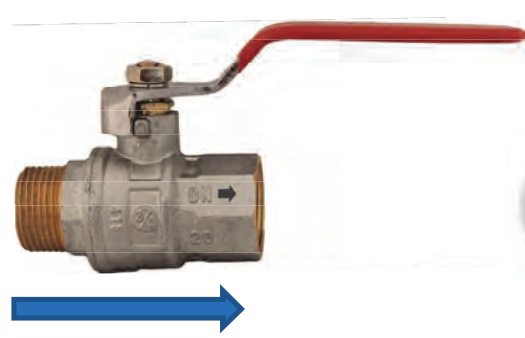

Misura / A	DN	W	C	D	gr.		
1/2"	15	21	62	50	205	12	120
3/4"	20	28	68	54	335	15	60
1"	25	34	79	61	460	10	40

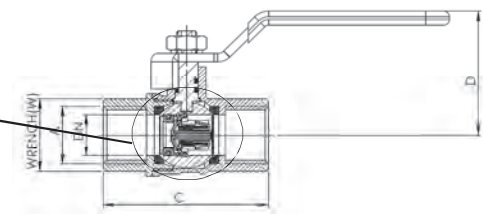

**Art.1715** Valvola M.F. con ritegno incorporato

*Fullway ball valve M.F. with check valve built-in*

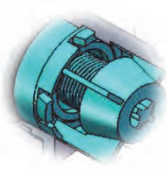
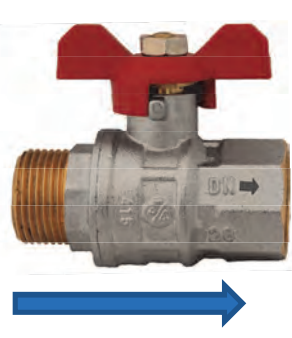

Misura / A	DN	W	C	D	gr.		
1/2"	15	21	62	38	169	12	120
3/4"	20	28	68	46	305	20	80
1"	25	34	79	53	503	6	60

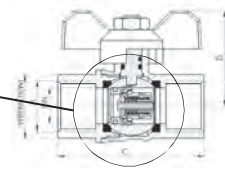

**Art.371** Valvola a sfera F.F. con spurgo

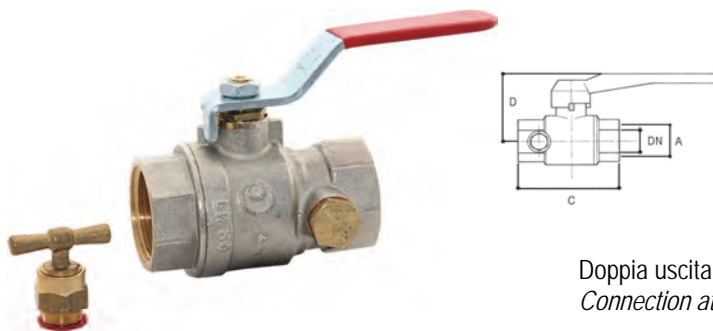
*Ball valve F.F. with discharge*

Misura	A	DN	C	D	gr.		
1/2"	1/2"	14	57	90	243	10	10
3/4"	3/4"	19	65	90	333	10	10
1"	1"	25	73	115	520	6	6
1.1/4"	1.1/4"	31	86	115	726	5	5
1.1/2"	1.1/2"	39	93	150	1030	5	5
2"	2"	49	109	180	1736	2	2

 Doppia uscita laterale (tappo/spurgo)  
 Connection at both sides (plug/discharge)

**Art.371/F** Valvola a sfera F.F. con spurgo

*Ball valve F.F. with discharge*



Misura	A	DN		
1/2"	1/2"	14	10	10
3/4"	3/4"	19	10	10
1"	1"	25	6	6

 Doppia uscita laterale (tappo/spurgo)  
 Connection at both sides (plug/discharge)

**Art.371/F/N**

 Con farfalla nera  
 With black "T" handle

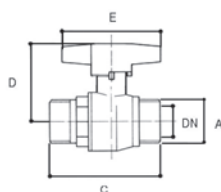
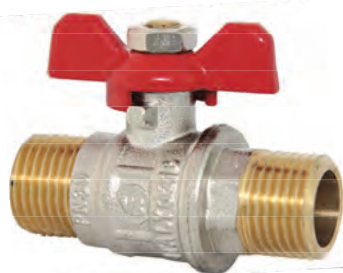
**Art.425** Valvola a sfera M.M. con farfalla

*Ball valve M.M. with wing handle*

Misura	A	DN	PN	C	D	gr.		
1/4"	1/4"	10	30				10	10
3/8"	3/8"	10	30				10	10
1/2"	1/2"	14	30	63	45	192	12	120
3/4"	3/4"	19	30	69	47	259	10	10
1"	1"	25	30	80	58	418	6	6

**Art.426** Valvola a sfera M.M. con maniglia

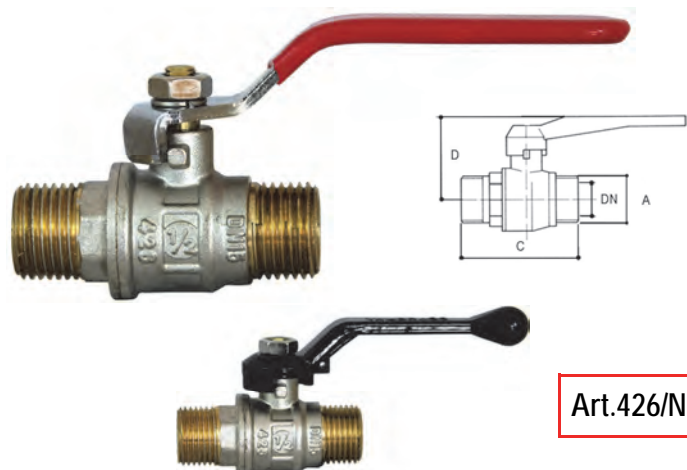
*Ball valve M.M. with handle*

Misura	A	DN	PN	C	D	gr.		
1/4"	1/4"	10	30				10	10
3/8"	3/8"	10	30				10	10
1/2"	1/2"	14	20	63	45	174	12	120
3/4"	3/4"	19	20	69	47	264	20	80
1"	1"	25	20	80	58	429	6	6
1.1/4"	1.1/4"	31	16	93	65	668	4	40
1.1/2"	1.1/2"	39	16	103	80	910	2	2
2"	2"					1550	2	2

**Art.426/N**

 Con maniglia in alluminio nera  
 With Black aluminium handle

**Art.259** Rubinetto a sfera a squadra M.F.

*Angle valve M.F.*

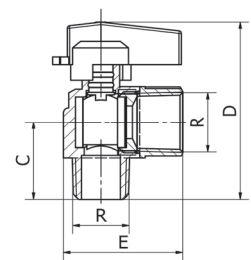

Misura / R	DN	PN	W	C	D	gr.		
1/2"	12	30	24	30	70	168	12	144

**Art.363/R/AS** Valvola a sfera M.F. girevole

*Ball valve M.F. outgoing female swivel*



Misura / A	DN	PN	W	C	D	gr.		
3/4"	14	30	25		37	204	10	120

**Art.364/G** Valvola a sfera M.F. girevole

*Ball valve M.F. outgoing female swivel*

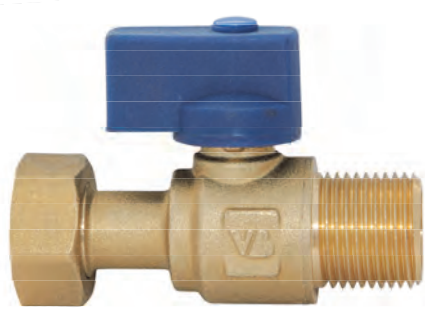

Misura / A	DN	PN	C	gr.		
1/2"	10	30	77	166	12	144
3/4"	15	30	77	215	10	120

**Art.415/F** Valvola a sfera F.F. con filtro

*Ball valve F.F. with filter*



Misura / A		
1/2"	1	1
3/4"	1	1
1"	1	1
1.1/4"	1	1
1.1/2"	1	1
2"	1	1

**Art.367** Valvola a sfera M.F. con filtro a "Y"

*Ball valve M.F. with "Y" filter*



Misura / A		
1/2"	1	1
3/4"	1	1

**Art.368** Valvola a sfera F.F. con filtro a "Y"

*Ball valve F.F. with "Y" filter*

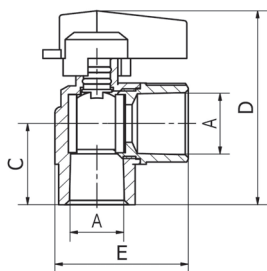

Misura / A		
1/2"	1	1
3/4"	1	1

**Art.246** Valvola a sfera a squadra F.F.

*Angle valve F.F.*

Misura / A	DN	PN	E	C	D	gr.		
1/2"	15	30	43	31	67	153	10	100
3/4"	20	30	47	35	77	225	8	96
1"	25	30	68	45	91	529	8	48

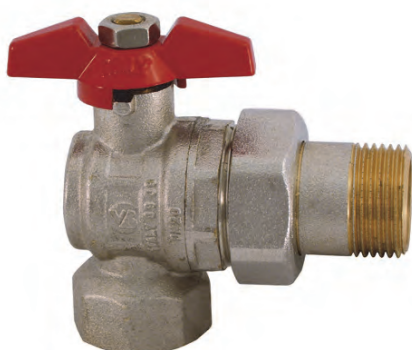
 con premistoppa  
*with stuffing box*
**Art.366** Valvola a sfera a 90° F.M. con bocchettone

*Angle ball valve 90° F.M. with pipe union*

Misura / A	DN	PN	W	C	D	gr.		
1/2"	14	30	25	70	65	222	10	100
3/4"	19	30	31	82	75	341	8	80
1"	24	30	48	93	91	578	4	40

 con premistoppa  
*with stuffing box*
**Art.366/B**

 Disponibile con farfalla Blu  
*Available with blue "T" handle*

**Art.365** Valvola a sfera F.M. con bocchettone

*Ball valve F.M. with pipe union*

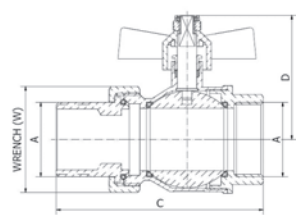
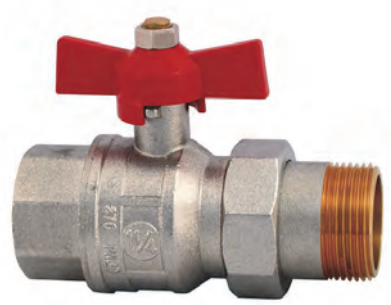

Misura / A	DN	PN	W	C	D	gr.		
1/2"	14	30	25	73	43	200	10	120
3/4"	19	30	31	80	46	274	10	100
1"	24	30	38	91	54	469	6	48
1.1/4"	32	25	47	106	66	660	4	36
1.1/2"	40	25	54	127	79	1195	2	20

con premistoppa  
*with stuffing box*

**Art.370** Valvola a sfera F.M. con bocchettone

*Ball valve F.M. with pipe union*

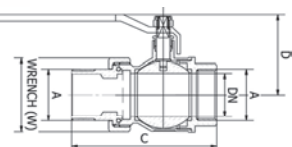
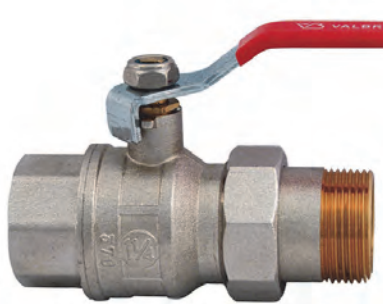

Misura / A	DN	PN	W	C	D	gr.		
1/2"	14	30	25	73	43	200	10	120
3/4"	19	30	31	80	46	307	10	100
1"	24	30	38	91	54	515	6	48
1.1/4"	32	25	47	106	66	730	4	36
1.1/2"	40	25	54	127	79	1195	2	20
2"	50	20	66	146	91	1823	2	16
2.1/2"	64	18	95	185	124	3540	1	1
3"							1	1
4"							1	1

Con premistoppa  
*With stuffing box*

\* Prezzi su richiesta / *Prices on request*



**Art.370/N**

Con maniglia in alluminio nera  
*With Black aluminium handle*

**Art.372** Valvola a sfera F.M. con bocchettone

*Ball valve F.M. with pipe union*

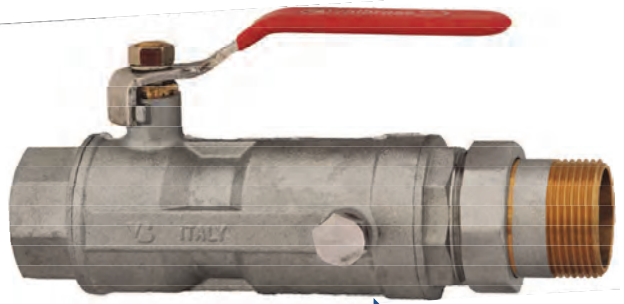

Con valvola di ritegno incorporata  
*With check valve built-in*

Misura / A	DN	PN	W	C	D	gr.		
1"	24	30	46	163	51	874	3	36
1.1/4"	32	25	52	203	63	1454	2	16
1.1/2"	40	25	64	215	68	1838	2	16

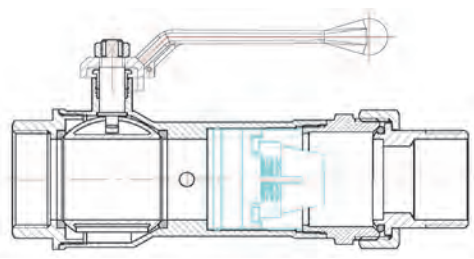

**Art.372/N**

Con maniglia in alluminio nera  
*With Black aluminium handle*

**Art.499** Valvola a sfera F.F. per contatori acqua

*Ball valve F.F. for water meters*

Misura / A	DN		
1/2" x 3/4"	15	5	50

Con ritegno incorporato e 2 prese di pressione  
Sfera a risciacquo automatico

*With check valve incorporated,  
2 pressure measurement connections  
Automatic rinse system*

**Art.799** Valvola con portagomma e lancia di lavaggio

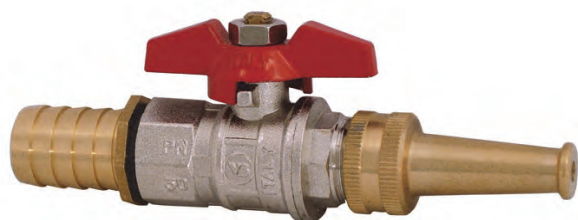
*Ball valve with hose connector and hose pipe nozzle*

Misura	A	C	gr.		
1/2" x 20	20	131	227	12	12
3/4" x 20	20	139	299	10	10
3/4" x 25	25	141	302	10	10

**Art.414/SC** Valvola con dispositivo di chiusura automatica

*Self closing ball valve*

Misura	A	DN	gr.		
1/2"	1/2"	14	198	12	12
1"	1"	24	389	10	10

Altre misure su richiesta

*Other sizes on request*

**Art.465/T** Valvola minisfera M.F. con teflon

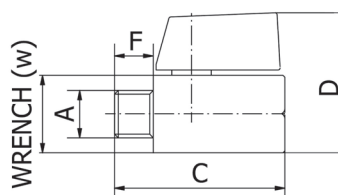
*Ball valve "mini" M.F. with teflon*

Misura	A	F	W	C	D	gr.		
1/4"	1/4"	11	21	41	35	87	25	300



Maniglia in alluminio rossa  
Con anello in teflon

*Red aluminium handle  
With teflon ring*

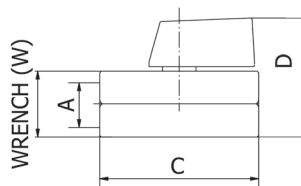

**Art.460** Valvola minisfera F.F. con maniglia



*Ball valve "mini" F.F.*

Misura	A	W	C	D	gr.		
1/8"	1/8"	21	41	37	111	25	300
1/4"	1/4"	21	40	37	100	25	200
3/8"	3/8"	21	40	37	88	25	300
1/2"	1/2"	25	46	41	119	18	252
3/4"	3/4"	30	51	47	189	10	10

**Art.461** Con maniglia in alluminio nera  
*With Black aluminium handle*

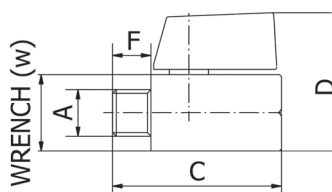
**Art.465** Valvola minisfera M.F.

*Ball valve "mini" M.F.*

Misura	A	F	W	C	D	gr.		
M10 x 1	M10	10	21	41	37	91	25	300
1/8"	1/8"	9	21	41	37	87	25	300
1/4"	1/4"	11	21	47	35	87	25	300
3/8"	3/8"	10	21	47	35	88	25	300
1/2"	1/2"	12	25	46	40	106	18	216
3/4"	3/4"	14	30	51	47	173	15	180

**Art.466** Con maniglia in alluminio nera  
*With Black aluminium handle*

**Art.465/S** Con maniglia in alluminio cromata  
*With chrome plated aluminium handle*

**Art.461/F** Valvola minisfera F.F. stampata sabbata

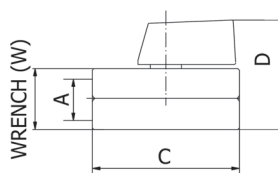
*Ball valve "mini" F.F.*

Misura	A	W	C	D	gr.		
1/4"	1/4"	21	39	31	95	25	300
3/8"	3/8"	21	39	31	86	25	300
1/2"	1/2"	24,5	43	32	100	20	240

Maniglia in NYLON-66 NERA

*BLACK NYLON-66 handle*
**Art.466/F** Valvola minisfera M.F. stampata sabbata

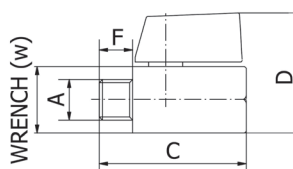
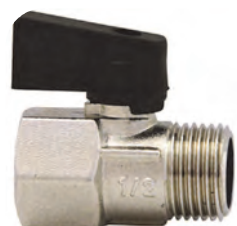
*Ball valve "mini" M.F.*

Misura	A	F	W	C	D	gr.		
1/4"	1/4"	10	21	39	31	87	25	300
3/8"	3/8"	10	21	39	31	80	25	300
1/2"	1/2"	12	24,5	43	32	90	18	216

Maniglia in NYLON-66 NERA

*BLACK NYLON-66 handle*

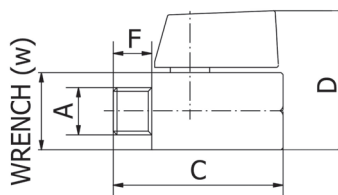
**Art.466/FA** Valvola minisfera M.F. stampata sabbiata *Ball valve "mini" M.F.*

Misura	A	F	W	C	D	gr.		
1/4"	1/4"	10	21	39	31	87	25	300
3/8"	3/8"	10	21	39	31	80	25	300
1/2"	1/2"	12	24,5	43	32	90	18	216

Maniglia in ALLUMINIO NERA

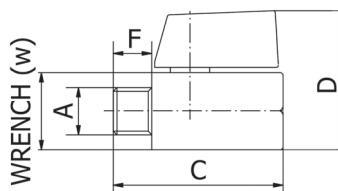
*BLACK ALUMINIUM handle*
**Art.466/FA/B** Valvola minisfera M.F. stampata sabbiata *Ball valve "mini" M.F.*

Misura	A	F	W	C	D	gr.		
1/4"	1/4"	10	21	39	31	87	25	300
3/8"	3/8"	10	21	39	31	80	25	300
1/2"	1/2"	12	24,5	43	32	90	18	216

Maniglia in ALLUMINIO BLU

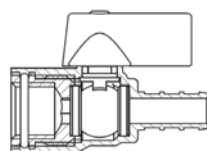
*BLUE ALUMINIUM handle*
**Art.380** Valvola minisfera F. con portagomma  $\varnothing 12$  *Ball valve "mini" F. with hose connector  $\varnothing 12$* 

Misura	A	$\varnothing$	W	C	D	gr.		
1/4" x 12	1/4"	12	20	45	31	69	75	300

Maniglia in ALLUMINIO ROSSA

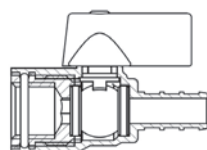
*RED ALUMINIUM handle*
**Art.381** Valvola minisfera F. con portagomma  $\varnothing 9$  *Ball valve "mini" F. with hose connector  $\varnothing 9$* 

Misura	A	$\varnothing$	W	C	D	gr.		
1/4" x 9	1/4"	9	20	45	31	67	75	300

Maniglia in ALLUMINIO NERA

*BLACK ALUMINIUM handle*

**Art.407** Valvola a sfera F.F.F. a 3 vie a "L" PN 40

*3 ways ball valve F.F.F. "L" port PN 40*

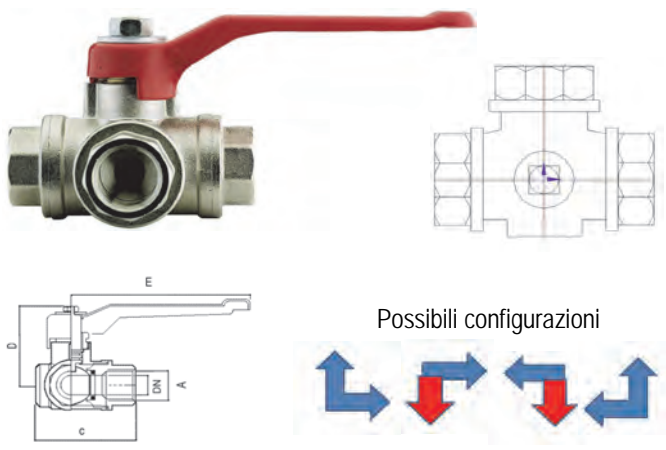

Misura / A	DN	PN	E	C	D	gr.		
1/4"	10	40	115	63	52	681	6	36
3/8"	10	40	115	63	52	639	6	36
1/2"	10	40	115	65	52	659	5	30
3/4"	15	40	115	74	56	863	4	16
1"	20	40	150	86	64	1468	3	12
1.1/4"	25	40	150	96	68	4000	1	6
1.1/2"	32	40	240	115	94	3742	1	5
2"	40	40	240	130	104	5680	1	3
2.1/2"	50	40	240	154	124	9500	1	1

**Disponibili anche con PASSAGGIO TOTALE**  
*Available also with TOTAL FULL BORE*

**Art.408** Valvola a sfera F.F.F. a 3 vie a "T" PN 40

*3 ways ball valve F.F.F. "T" port PN 40*

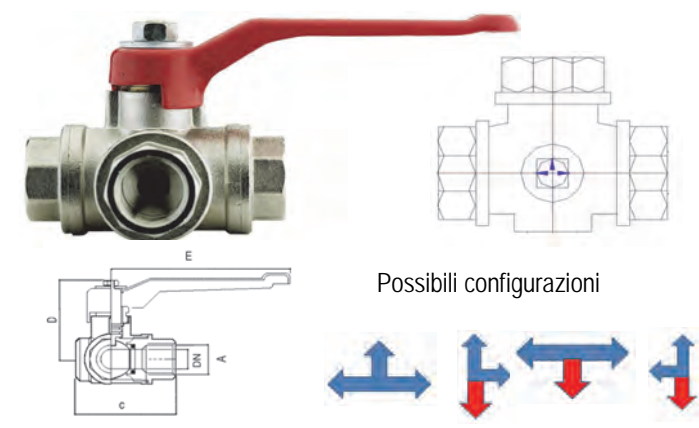

Misura / A	DN	PN	E	C	D	gr.		
1/4"	10	40	115	63	52	658	6	36
3/8"	10	40	115	63	52	631	6	36
1/2"	10	40	115	65	52	647	5	30
3/4"	15	40	115	74	56	852	4	16
1"	20	40	150	86	64	1452	3	12
1.1/4"	25	40	150	96	68	2021	1	6
1.1/2"	32	40	240	115	94	3681	1	5
2"	40	40	240	130	104	5560	1	3
2.1/2"	50	40	240	154	124	9500	1	1

**Disponibili anche con PASSAGGIO TOTALE**  
*Available also with TOTAL FULL BORE*

**Art.411** Valvola a sfera F.F.F. a 3 vie a "L" PN 25

*3 ways ball valve F.F.F. "L" port PN 25*

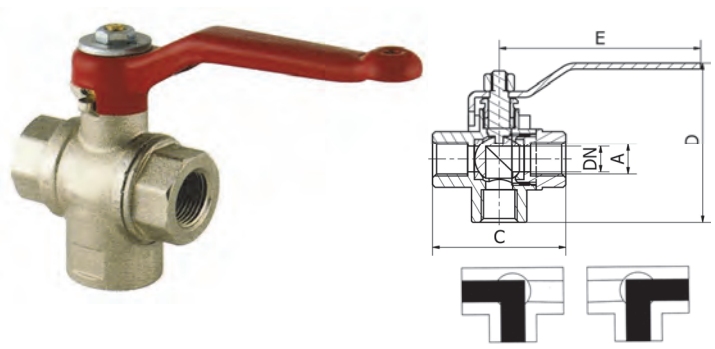

Misura / A	DN	PN	E	C	D	gr.		
1/4"	10	16	92	54	48	173	15	150
3/8"	10	16	92	54	48	362	15	90
1/2"	15	16	92	54	48	311	15	90
3/4"	20	16	92	66	50	429	12	72
1"	25	16	115	75	55	615	8	48
1.1/4"	32	16	150	85	62	986	6	24
1.1/2"	40	16	150	97	62	1546	4	16
2"	48	16	150	109	62	2750	4	16
3"	80	16	240	184	129	8200	1	3

*Art.411/A - con attacco attuatore - With actuator connection*

**Art.413** Valvola a sfera F.F.F. a 3 vie a "T" PN 25

*3 ways ball valve F.F.F. "T" port PN 25*

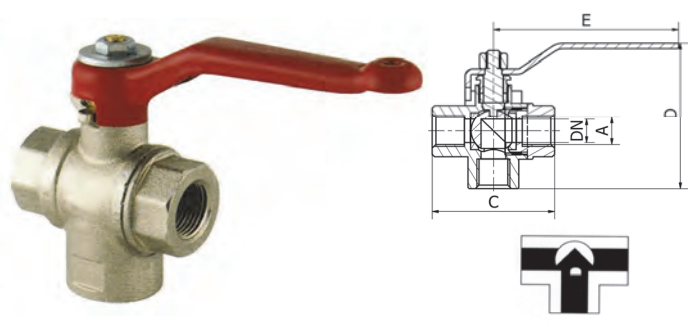

Misura / A	DN	PN	E	C	D	gr.		
1/4"	10	16	92	54	48	381	15	90
3/8"	10	16	92	54	48	358	15	90
1/2"	15	16	92	54	48	308	15	90
3/4"	20	16	92	66	50	437	12	72
1"	25	16	115	75	55	624	8	48
1.1/4"	32	16	150	85	62	1019	6	24
1.1/2"	40	16	150	97	62	1550	4	16
2"	48	16	150	109	62	2755	4	16
3"	80	16	240	184	129	8200	1	3

*Art.413/A - con attacco attuatore - With actuator connection*

**Art.400** Valvola a sfera a incasso con deviatore

*Built-in shower full bore ball valve with lever*

Misura	A	DN	C	D	gr.		
1/2"	1/2"	15	58	43/18	367	6	1
3/4"	3/4"	20	70	50/30	560	6	1

**Art.405** Valvola a sfera a incasso con cappuccio

*Built-in full bore ball valve with lever*



Misura	A	DN	C	D	gr.		
1/2"	1/2"	15	58	48/33	350	6	1
3/4"	3/4"	20	70	57/41	674	6	1

**Art.406** Valvola a sfera a incasso con maniglia tonda

*Built-in ball valve with handle*

Misura	A	DN	C	D	gr.		
1/2"	1/2"	15	58	43/18	373	6	1
3/4"	3/4"	20	70	50/30	471	6	1

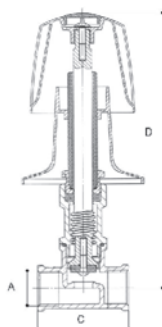
**Art.403** Valvola a incasso LUNGA

*Valvola de ducha*

Misura	A	DN	C	D	gr.		
1/2"	1/2"	15	52	160	468	2	2

**SEDE ESTRAIBILE**
**ASIEN TO DESMONTABLE**

## VALVOLE A SFERA A PASSAGGIO TOTALE, SERIE EXTRA PESANTE PN50 ( 9 filetti)

*Ball valves full bore, Extra Heavy Type (9 threads)*

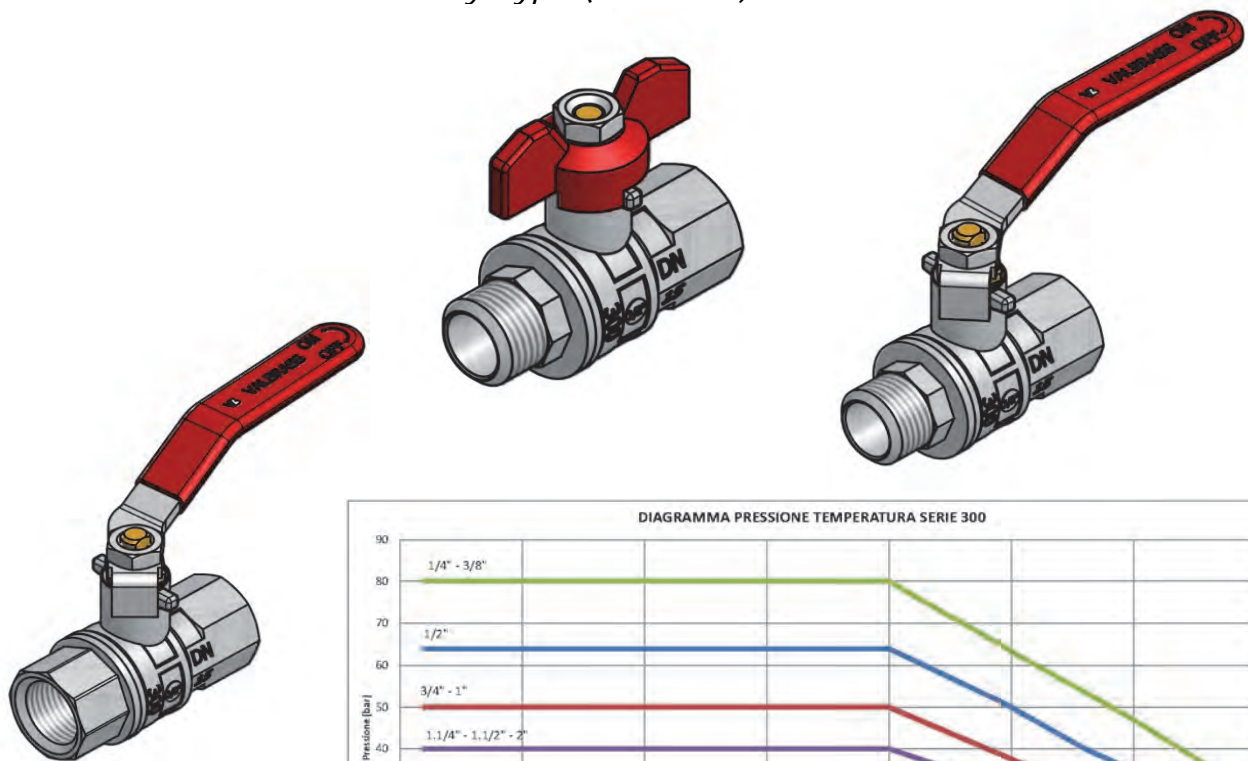

### Caratteristiche tecniche *Technical features*

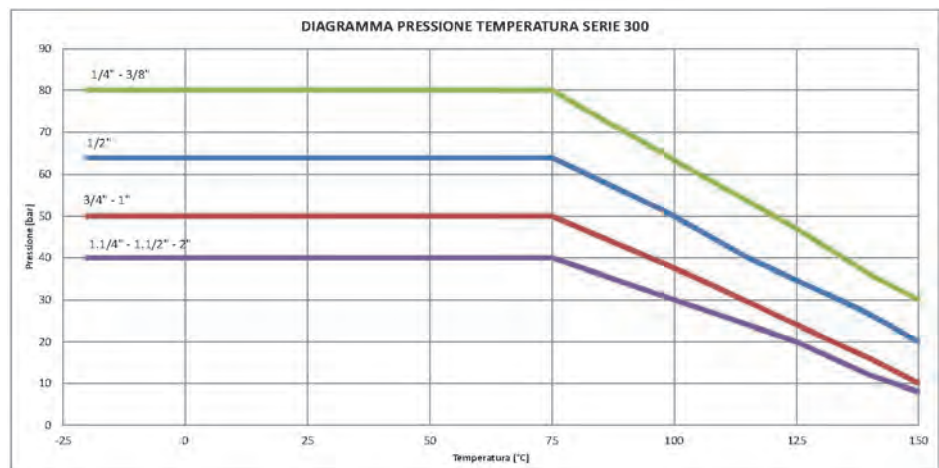

Corpo e sfera : Ottone CW617N UNI EN 12165  
 Asta e premistoppa : Ottone CW614N UNI EN 12164  
 Sfera lavorata con utensile al diamante e cromata a spessore  
 Sedi in P.T.F.E. vergine  
 Guarnizione di tenuta asta in P.T.F.E.  
 Finitura superficiale sabbiata e nichelata  
 Maniglia : disponibile in acciaio cromato rivestito in gomma (rossa), acciaio INOX AISI 304  
 rivestito in gomma (gialla), o alluminio (farfalla rossa o maniglia lunga nera)  
 Temperatura di esercizio : -20° C / +180° C  
 Filettature : ISO 7 / ISO 228

*Body and Ball : Brass CW617N UNI EN 12165*  
*Stem and stuffing box : Brass CW614N UNI EN 12164*  
*Ball diamond machined and chromed*  
*Seats and stem's gaskets in pure P. T.F.E.*  
*Surface sand blasted and nickel plated*  
*Handle : available in chromed steel rubber covered (red), stainless steel AISI 304*  
*rubber covered (yellow), or aluminium (red wing handle or long black handle)*  
*Working temperatures : -20° C / +180° C*  
*Threads : ISO 7 / ISO 228*

**Art.300** Valvola a sfera F.F. passaggio Totale

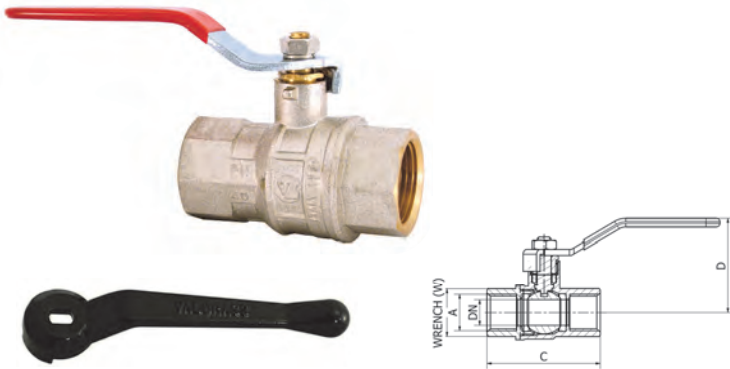
*Fullway ballvalve F.F.*

Misura / A	DN	W	C	D	gr.		
1/4"	10	21	53	52	221	12	144
3/8"	10	21	53	52	205	12	144
1/2"	15	26	64	52	257	12	96
3/4"	20	32	72	65	407	12	72
1"	25	39	85	69	586	6	48
1.1/4"	32	48	98	78	895	4	32
1.1/2"	40	55	106	86	1200	4	24
2"	50	68	126	95	1920	2	16
2.1/2"	64	83	131	126	2825	1	1
3"	73	96	153	133	3905	1	1
4"	90	125	170	143	6540	1	1

**Art.300/N** Con maniglia in alluminio nera  
*With black aluminium handle*
**Art.305** Valvola a sfera M.F. passaggio Totale

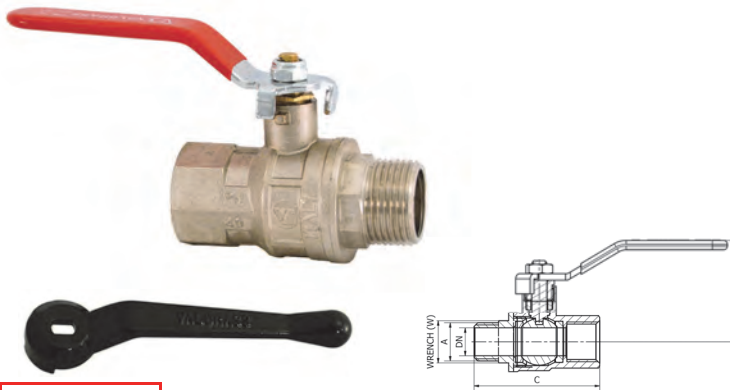
*Fullway ballvalve F.F.*

Misura / A	DN	W	C	D	gr.		
1/4"	10	18	58	52	218	12	144
3/8"	10	18	58	52	207	12	144
1/2"	15	22	64	50	249	12	96
3/4"	20	28	76	65	383	12	72
1"	25	34	90	69	568	6	48
1.1/4"	32	43	105	78	868	4	32
1.1/2"	40	49	111	86	1190	2	24
2"	50	60	128	95	1858	2	16
2.1/2"	64	83	144	126	2968	1	1
3"	73	96	159	133	4075	1	1
4"	90	121	187	143	6360	1	1

**Art.305/N** Con maniglia in alluminio nera  
*With black aluminium handle*
**Art.310** Valvola a sfera F.F. passaggio Totale

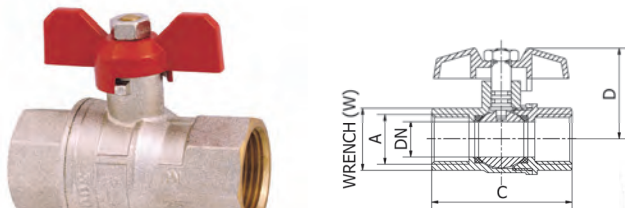
*Fullway ballvalve M.F.*

Misura / A	DN	W	C	D	gr.		
1/2"	15	26	64	45	257	12	96
3/4"	20	32	72	60	407	12	72
1"	25	39	85	64	586	6	48

**Art.310/N** Con farfalla in alluminio nera  
*With black "T" handle*
**Art.315** Valvola a sfera M.F. passaggio Totale

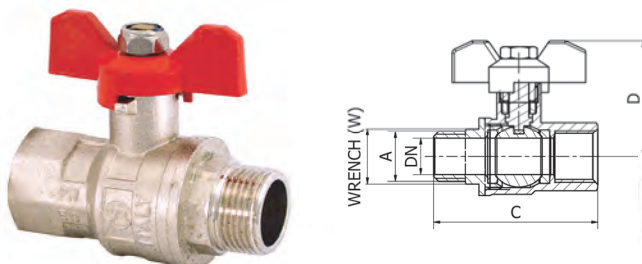
*Fullway ballvalve M.F.*

Misura / A	DN	W	C	D	gr.		
1/2"	15	22	65	45	216	12	96
3/4"	20	28	76	60	360	12	72
1"	25	34	90	64	530	6	48

**Art.315/N** Con farfalla in alluminio nera  
*With black "T" handle*

## VALVOLE A SFERA A PASSAGGIO TOTALE PER GAS A NORMA EN 331

*Ball valves full bore for gas according to EN 331 norm*

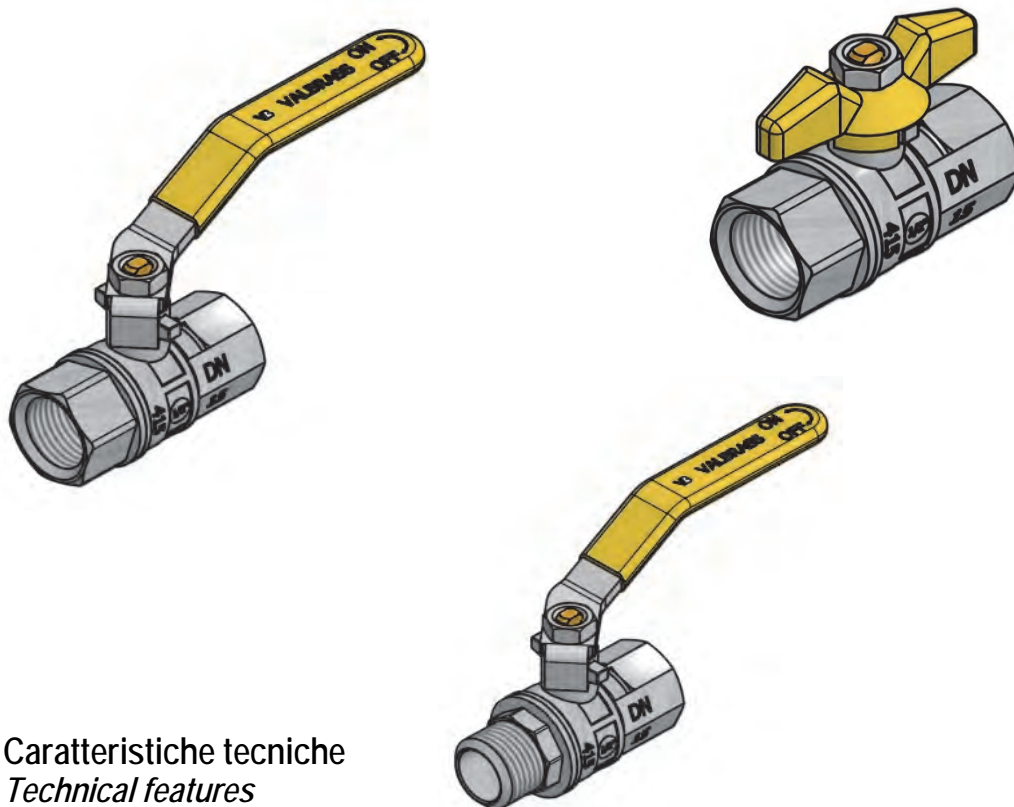

### Caratteristiche tecniche

*Technical features*

---

Corpo e sfera : Ottone CW617N UNI EN 12165  
 Asta e premistoppa : Ottone CW614N UNI EN 12164, montata dall'interno (antiscoppio)  
 Sfera lavorata con utensile al diamante e cromata a spessore  
 Sedi in P.T.F.E. vergine  
 Guarnizioni di tenuta asta : 2 O-Rings in HNBR  
 Finitura superficiale sabbata e nichelata  
 Maniglia : disponibile in acciaio cromato rivestito in gomma (gialla)  
                   o alluminio (farfalla gialla)  
 Temperatura di esercizio : -20° C / +60° C  
 Filettature : ISO 7/1  
 Limiti di pressione : MOP5

---

*Body and Ball : Brass CW617N UNI EN 12165*  
*Stem and stuffing box : Brass CW614N UNI EN 12164 (blow out proof)*  
*Ball diamond machined and chromed*  
*Seats in P.T.F.E., stem with 2 O-Rings in HNBR*  
*Surface sand blasted and nickel plated*  
*Handle : available in chromed steel rubber covered (red) or aluminium (yellow wing handle)*  
*Working temperatures : -20° C / +60° C*  
*Threads : ISO 7/1*  
*Pressure limits : MOP5*

---

**Art.451** Valvole a sfera per gas F.F.

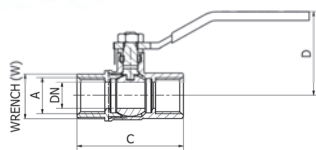
*Fullway ball valve for gas F.F.*

Con leva

*With lever*

Misura	A	DN	W	C	D	gr.		
1/4"	1/4"	10	21	46	42	146	12	192
3/8"	3/8"	10	21	46	42	132	12	192
1/2"	1/2"	15	25	58	50	188	12	120
3/4"	3/4"	20	31	64	54	257	12	96
1"	1"	25	38	80,6	61	426	6	60
1.1/4"	1.1/4"	32	47	92,5	72	658	4	40
1.1/2"	1.1/2"	40	54	102,5	77	910	2	24
2"	2"	50	66	118	92	1477	2	20
2.1/2"	2.1/2"	61	85	140	131	3026	1	1
3"	3"	74	99	159	140	4140	1	1
4"	4"	95	125	195	156	6750	1	1

**Art.452** Valvole a sfera per gas M.F.

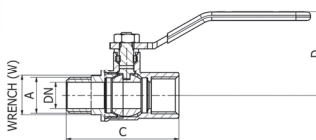
*Fullway ball valve for gas M.F.*

Con leva

*With lever*

Misura	A	DN	W	C	D	gr.		
1/4"	1/4"	10	21	54	41	150	12	192
3/8"	3/8"	10	21	54	41	147	12	192
1/2"	1/2"	15	25	68,5	50	183	12	120
3/4"	3/4"	20	31	64	54	308	12	96
1"	1"	25	38	90	62	443	6	60
1.1/4"	1.1/4"	32	48	102	71	6	40	
1.1/2"	1.1/2"	40	55	117	80	4	24	
2"	2"	50	68	137	88	2	20	

**Art.453** Valvole a sfera per gas F.F.

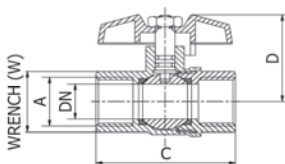
*Fullway ball valve for gas F.F.*

Con farfalla

*With "T" handle*

Misura	A	DN	W	C	D	gr.		
1/4"	10	10	21	46	42	105	12	192
3/8"	10	10	21	46	42	105	12	192
1/2"	15	15	25	58	50	156	12	120
3/4"	20	20	31	64	54	286	12	96
1"	25	25	38	80,6	61	379	6	60

**Art.454** Valvole a sfera per gas M.F.

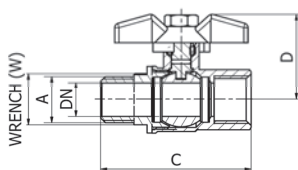
*Fullway ball valve for gas M.F.*

Con farfalla

*With "T" handle*



Misura	A	DN	W	C	D	gr.		
1/4"	1/4"	10	21	54	41	111	12	192
3/8"	3/8"	10	21	54	41	109	12	192
1/2"	1/2"	15	21	62	38	169	12	120
3/4"	3/4"	20	28	68	46	279	12	96
1"	1"	25	34	90	53	402	6	60

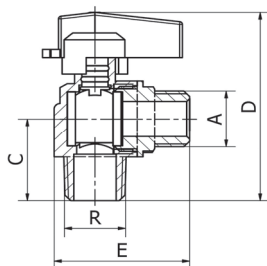

**Art.256**

Rubinetto a sfera a squadra per gas M.M.



*Angle valve for gas M.M.*

Misura / A	DN	R	E	C	D	gr.		
1/2"	12	1/2"	47	30	70	176	30	120

**Art.257**

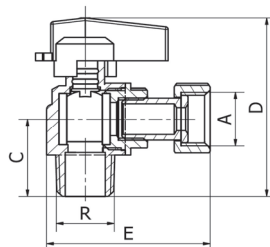
Rubinetto a sfera a squadra per gas M.



*Angle valve for gas M.*

Misura / A	DN	R	E	C	D	gr.		
1/2" x 1/2"	12	1/2"	60	30	70	200	12	144
1/2" x 3/4"	12	1/2"	59	30	70	218	12	144

**Art.258**

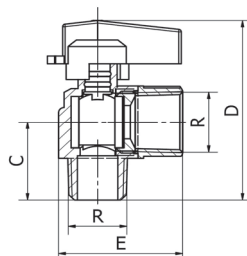
Rubinetto a sfera a squadra per gas M.F.



*Angle valve for gas M.F.*

Misura / A	DN	R	E	C	D	gr.		
1/2" x 1/2"	12	1/2"	45	30	70	168	12	144

**Art.480**

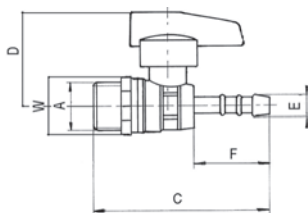
Rubinetto a sfera M. per gas METANO



*Ball valve for gas straight - male*

Misura / A	F	W	E	C	D	gr.		
1/2"	30	24	14	76	40	136	12	12

**Art.485**

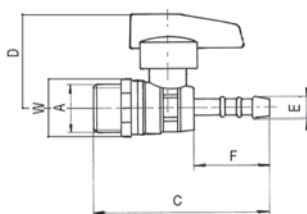
Rubinetto a sfera M. per GPL

*Ball valve for LPG straight - male*

Misura / A	F	W	E	C	D	gr.		
1/2"	24	24	10	73	40	139	12	192

**Art.495** Rubinetto a sfera F. per GPL

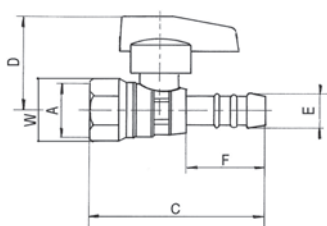
*Ball valve for LPG straight - female*

Misura / A	F	W	E	C	D	gr.		
1/2"	23	25	10	60	40	118	14	224

**Art.500** Rubinetto a sfera M. a squadra per METANO

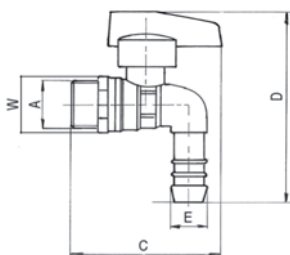
*Curved ball valve for gas - male*

Misura / A	F	W	E	C	D	gr.		
1/2"	30	24	14	67	87	158	16	192

**Art.505** Rubinetto a sfera M. a squadra per GPL

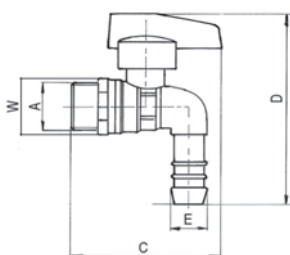
*Curved ball valve for LPG - male*

Misura / A	F	W	E	C	D	gr.		
1/2"	23	24	10	69	80	157	16	192

**Art.510** Rubinetto a sfera F. a squadra per METANO

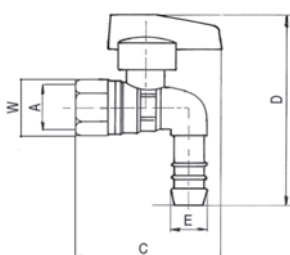
*Curved ball valve for gas - female*

Misura / A	F	W	E	C	D	gr.		
1/2"	30	25	14	56	87	154	12	144

**Art.515** Rubinetto a sfera F. a squadra per GPL

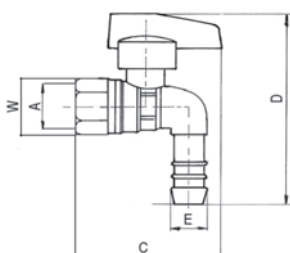
*Curved ball valve for LPG - female*

Misura / A	F	W	E	C	D	gr.		
1/2"	24	24	10	55	87	142	12	144

## VALVOLE DI RITEGNO CHECK VALVES

### Art. 110 - 130 - 150

Valvola di ritegno con perno in NYLON (fibra di vetro 33%) e guarnizione in NBR

*Check valve with NYLON (fiber Glass 33%) shutter and NBR gasket*

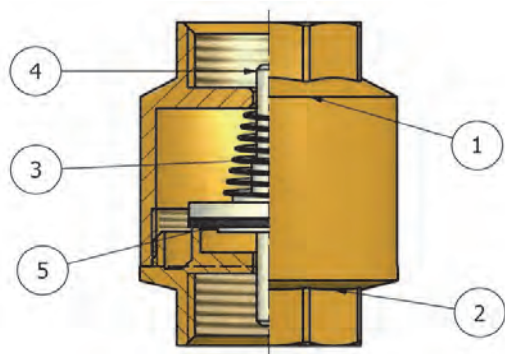

Parti / Parts		
Elemento / Element	Descrizione / Description	Materiale / Material
1	corpo / body	CW 617 N
2	tappo / bonnet	CW 617 N
3	molla / spring	AISI 302
4	perno / shutter	NYLON
5	guarnizione / gasket	NBR

#### Caratteristiche tecniche Technical features

Filettature: ISO228

Disponibile anche nella filettatura americana NPT

Temperatura max di esercizio : 90°C, picco 110°C

Pressione di apertura: 0.02 bar

Può essere installata in qualsiasi posizione

Fluidi compatibili: acqua, olio, gasolio, aria e fluidi non aggressivi

*Threads: ISO 228 and NPT american threads*

*Max temperature of use: 90°C, peak 110°C*

*Opening pressure: 0.02 bar*

*It can be installed in any position*

*Fluids compatibles: water, oil, diesel, air and not aggressive fluids*

### Art. 132 - 151

Valvola di ritegno con perno in OTTONE (100%) e guarnizione in VITON

*Check valve with BRASS shutter and VITON gasket*

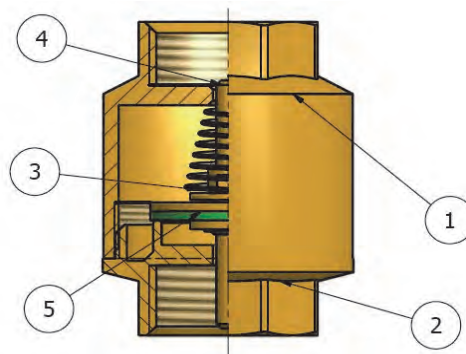

Parti / Parts		
Elemento / Element	Descrizione / Description	Materiale / Material
1	corpo / body	CW 617 N
2	tappo / bonnet	CW 617 N
3	molla / spring	AISI 302
4	perno / shutter	CW 614 N
5	guarnizione / gasket	VITON

#### Caratteristiche tecniche Technical features

Filettature: ISO228

Disponibile anche nella filettatura americana NPT

Temperatura: da -40°C a 200 °C

Pressione di apertura: 0.02 bar

Può essere installata in qualsiasi posizione

Fluidi compatibili: acqua, olii e idrocarburi, aria, agenti chimici, solventi, la maggior parte degli acidi minerali, soluzioni saline e acqua di mare

*Threads: ISO 228 and NPT american threads*

*Temperature of use: from - 40 °C to 200°C*

*Opening pressure: 0.02 bar*

*It can be installed in any position*

*Fluids compatibles: water, oil, hydrocarbons, air and chemical agents, solvents, most of mineral acids, saline solutions and seawater*

**Art.110** Valvola di ritegno "NEW" PN 25

Check valve "NEW" PN 25

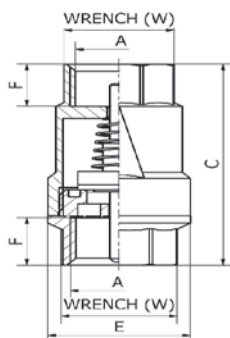

Misura	A	F	W	E	C	gr.	
1/2"	1/2"	13	24	30	56,5	107	25
3/4"	3/4"	12	30	38	59	154	10
1"	1"	13,5	37	46	61,5	222	24
1.1/4"	1.1/4"	13	47	56	64	340	10
1.1/2"	1.1/2"	16,5	51,5	66	76	478	8
2"	2"	17	65	76,5	77	690	4

Valvola di non ritorno con otturatore in Nylon e guarnizione in NBR, adatta alla maggior parte delle applicazioni  
Adatta anche per uso gasolio

*Check valve with shutter in Nylon and NBR gasket, usable for most applications  
Suitable also for diesel use*

**Stesse dimensioni e caratteristiche dell'Art.130**  
(differisce solo l'estetica)

**Same dimensions and features of Art.130**  
(only different aesthetic)

**Art.130** Valvola di ritegno "JUPITER" PN 25

Check valve "JUPITER" PN 25

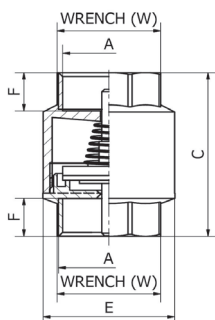

Misura	A	F	W	E	C	gr.	
1/2"	1/2"	13	24	30	57	125	24
3/4"	3/4"	13	30	38	59	181	10
* 1"	1"	14	37	46	63	259	24
1.1/4"	1.1/4"	13	47	56	63,5	360	10
1.1/2"	1.1/2"	16,5	52	65	74,5	529	6
2"	2"	17	65	76,5	78	754	6
2.1/2"	2.1/2"	17	81	106	86	1280	1
3"	3"	18	94,5	120	103	1700	1
4"	4"	18	121	156	112	3000	1

Valvola di non ritorno con otturatore in Nylon e guarnizione in NBR, adatta alla maggior parte delle applicazioni  
Adatta anche per uso gasolio

*Check valve with shutter in Nylon and NBR gasket, usable for most applications  
Suitable also for diesel use*

\* Versioni disponibili :

- con dispositivo di sovrappressione (Art. 131-1") .
- con molla ad alta pressione, apertura 0,7 bar (Art.133-1")

**Art.130/L** Valvola di ritegno F.F. PN 10

Check valve F.F. PN 10

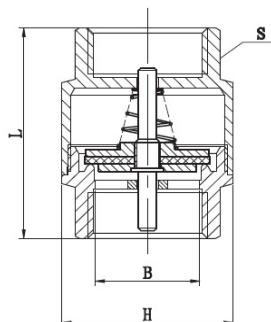

Misura	A	B	H	L	S		
1/2"	1/2"	17,5	35,5	46,8	24,8	45	270
3/4"	3/4"	23	41,7	51,4	30,3	30	180
1"	1"	28,8	47,2	59,5	37,5	20	120
1.1/4"	1.1/4"	37,4	59,3	64,5	46,2	12	72
1.1/2"	1.1/2"	43,2	67,6	73,3	53	5	45
2"	2"	54,8	73,7	80,2	66	4	24
2.1/2"	2.1/2"	71	95	94	82	1	12
3"	3"	84	110	100	95	1	12
4"	4"	108	144	112	121	1	6

Valvola di non ritorno con otturatore in ABS e guarnizione in NBR

*Check valve with shutter in ABS and NBR gasket*

## Art.150

## Valvola di ritegno "JOLLY" PN 40

## Check valve "JOLLY" PN 40



Valvola di non ritorno con otturatore in Nylon e guarnizione in NBR. E' caratterizzata da basse perdite di carico grazie al passaggio maggiorato. Adatta anche per uso gasolio.

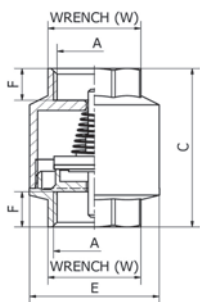

Heavy check valve with shutter in Nylon and NBR gasket. It has low loss of pressure thanks to full bore. Suitable also for diesel use.

Misura	A	F	W	E	C	gr.	
1/4"	1/4"	13	18	30	52	120	25
3/8"	3/8"	13	22	32	61	128	24
1/2"	1/2"	12	26	32	57	161	25
3/4"	3/4"	15,5	31	42,5	64,5	252	16
1"	1"	14	38	52,5	68	350	10
1.1/4"	1.1/4"	13	48	62	74,5	517	8
1.1/2"	1.1/2"	16	55	72	83	713	6
2"	2"	19	67,5	82	90	974	5
* 2.1/2"	2.1/2"	21	88	118	119	2578	1
* 3"	3"	30,5	100	139	138	4170	1
* 4"	4"	34	126	153	157	6210	1

(\*) = Con otturatore in ottone Art.134

(\*) = With brass shutter Art. 134

## Art.134

## Valvola di ritegno "EURO" PN 25

## Check valve "EURO" PN 25



Valvola di non ritorno con otturatore in ottone, guarnizione NBR. Adatta anche per uso gasolio.

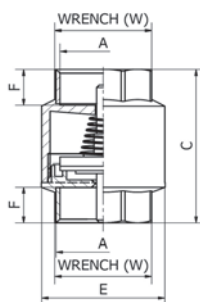

Check valve w/ brass shutter and NBR gasket. Suitable also for diesel use.

Misura	A	F	W	E	C	gr.	
1/4"	1/4"	13,5	20	34	54	169	20
3/8"	3/8"	13,5	21	34	54	169	20
1/2"	1/2"	12	25	34	56	180	20
3/4"	3/4"	14	31	42	64	260	12
1"	1"	15	40	47,5	75	418	15
1.1/4"	1.1/4"	18	50	60,5	83	646	8
1.1/2"	1.1/2"	19	55,5	71	94	865	6
2"	2"	19	67	78	100	1290	3
2.1/2"	2.1/2"	25	88	118	120	2597	1
3"	3"	30	100	139	139	4115	1
4"	4"	31	126	153	158	6240	1

Disponibile con guarnizione in VITON Art.134/V (prezzi +20%)

Available with VITON gasket Art.134/V (prices +20%)



**Art.132** Valvola di ritegno "JUPITER" PN 25

## Check valve "JUPITER" PN 25

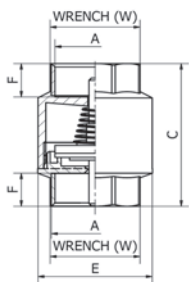

Misura	A	F	W	E	C	gr.	
1/2"	1/2"	13	24	30	57	137	24
3/4"	3/4"	13	30	38	59	209	10
1"	1"	14	37	46	63	291	12
1.1/4"	1.1/4"	13	47	56	63,5	431	12
1.1/2"	1.1/2"	16,5	52	67,5	74,5	585	8
2"	2"	17	65	78	78	855	6

Valvola di non ritorno con otturatore in Ottone e guarnizione in Viton. Stesse caratteristiche dimensionali e meccaniche dell'Art.130  
Adatta anche per uso carburante e acqua salata

*Check valve with shutter in Brass and Viton gasket. It has the same mechanical and dimensional specifications of Art.130  
Suitable also for fuel use and seawater*

**Art.132/LG** Valvola di ritegno F.F. PN 16

## Check valve F.F. PN 16

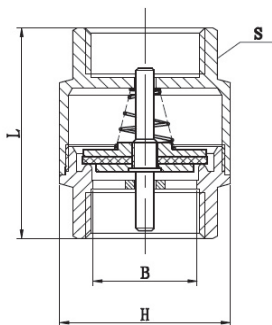

Misura	A	B	H	L	S		
1/2"	1/2"	17,5	35,5	46,8	24,8	45	270
3/4"	3/4"	23	41,7	51,4	30,3	30	180
1"	1"	28,8	47,2	59,5	37,5	20	120
1.1/4"	1.1/4"	37,4	59,3	64,5	46,2	12	72
1.1/2"	1.1/2"	43,2	67,6	73,3	53	5	45
2"	2"	54,8	73,7	80,2	66	4	24
2.1/2"	2.1/2"	71	95	94	82	1	12
3"	3"	84	110	100	95	1	12
4"	4"	108	144	112	121	1	6

Valvola di non ritorno con otturatore in ottone e guarnizione in NBR

*Check valve with shutter in Brass and NBR gasket*

**Art.151** Valvola di ritegno "JOLLY" PN 40

## Check valve "JOLLY" PN 40

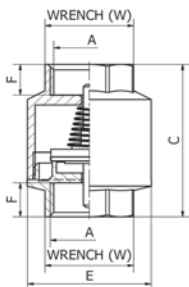

Misura	A	F	W	E	C	gr.	
1/2"	1/2"	12	26	32	57	161	24
3/4"	3/4"	15,5	31	42,5	64,5	252	18
1"	1"	14	38	52,5	68	350	10
1.1/4"	1.1/4"	13	48	62	74,5	517	8
1.1/2"	1.1/2"	16	55	72	83	532	6
2"	2"	19	67,5	82	90	974	5

Valvola di non ritorno con otturatore in Ottone e guarnizione in Viton. E' caratterizzata da basse perdite di carico grazie al passaggio maggiorato  
Adatta anche per uso carburante e acqua salata

*Heavy check valve with shutter in Brass and Viton gasket. It has low loss of pressure thanks to full bore*

*Suitable also for fuel use and seawater*

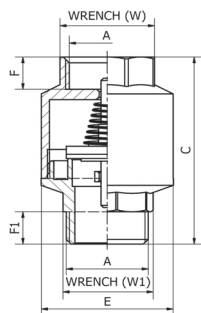

**Art.152/L** Valvola di ritegno "NEW" M → F PN 25

*Check valve "NEW" M→F PN 25*

Valvola di non ritorno F/M,  
con otturatore in  
Nylon e guarnizione  
in NBR. Aspirazione femmina  
Adatta anche per uso gasolio

*Heavy Check valve F/M with  
shutter in Nylon and NBR gasket.  
Female suction  
Suitable also for diesel use*

Misura / A	F	F1	W1	E	C	gr.	
1"	13,5	14	35	46	71	246	12

**Art.152/L/NPT**

Misura / A	F	F1	W1	E	C	gr.	
1"NPT	13,5	17,5	35	46	74,5	265	12

F.F.

**Art.152** Valvola di ritegno "JOLLY" M → F PN 40

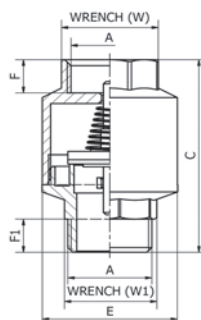
*Check valve "JOLLY" M→F PN 40*

Valvola di non ritorno M/F,  
pesante, con otturatore in  
Nylon e guarnizione  
in NBR. Aspirazione maschio  
Adatta anche per uso gasolio

*Heavy Check valve M/F with  
shutter in Nylon and NBR  
gasket. Male suction  
Suitable also for diesel use*

Misura / A	F	F1	W1	E	C	gr.	
3/4"	12	15,5	31	42,5	83	306	12
1"	14	14	35	52,5	80	357	10
1.1/4"	14	13	42	62	86,5	570	8
1.1/2"	16	16	48	72	97,5	753	6

A richiesta disponibile con otturatore in ottone e guarnizione Viton (Art.156)  
On request it is available with Shutter in Brass and Viton gasket (Art.156)

**Art.153/L** Valvola di ritegno "NEW" F → M PN 25

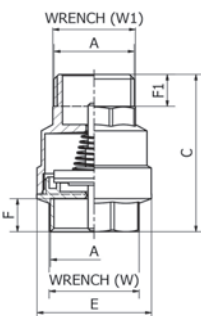
*Check valve "NEW" F→M PN 25*

Valvola di non ritorno F/M,  
pesante, con otturatore in  
Nylon e guarnizione  
in NBR. Aspirazione femmina  
Adatta anche per uso gasolio

*Heavy Check valve F/M with  
shutter in Nylon and NBR gasket.  
Female suction  
Suitable also for diesel use*

Misura / A	F	F1	W1	E	C	gr.	
1"	13,5	14	35	46	71	246	12

**Art.153** Valvola di ritegno "JOLLY" F → M PN 40

Check valve "JOLLY" F → M PN 40

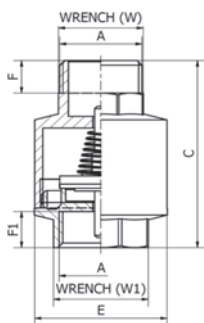

Misura / A	F	F1	W1	E	C	gr.	
3/4"	15,5	12	31	42,5	83	306	12
1"	14	14	35	52,5	80	364	10
1.1/4"	13	14	42	62	82	528	8
1.1/2"	16	16	48	72	93	716	6

Valvola di non ritorno F/M, pesante, con otturatore in Nylon e guarnizione in NBR. Aspirazione femmina. Adatta anche per uso gasolio.

Heavy Check valve F/M with shutter in Nylon and NBR gasket. Female suction. Suitable also for diesel use.

**Art.152/U** Valvola di ritegno PN 25 con bocchettone

Check valve PN 25 with union

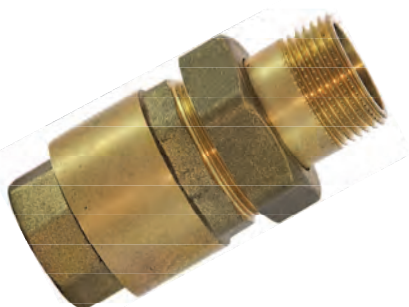

Misura	A	gr.	
1"	1"	445	12

Valvola di non ritorno con otturatore in Ottone e guarnizione in Viton. Stesse caratteristiche dimensionali e meccaniche dell'Art.130. NICHELATA. Adatta anche per uso carburante e acqua salata.

Check valve with shutter in Brass and Viton gasket. It has the same mechanical and dimensional specifications of Art.130. NICKEL PLATED. Suitable also for fuel use and seawater.

**Art.519** Valvola di ritegno a "Y" con molla

Check valve "Y" type with spring

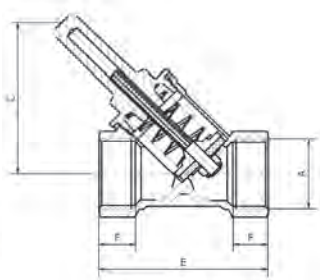

Misura	A	C	D		
1"	1"			6	54



## VALVOLE DI FONDO FOOT VALVES

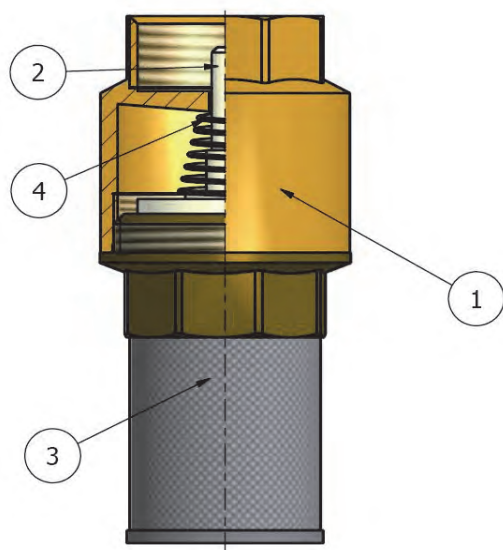

Parti / Parts		
Elemento / Element	Descrizione / Description	Materiale / Material
1	corpo / body	CW 617 N
2	perno / shutter	NYLON (sede NBR seat)
3	filtro / filter	AISI 304L
4	molla / spring	AISI 302

### Caratteristiche tecniche Technical features

Filettature: ISO228

Temperatura max di esercizio : 90°C, picco 110°C

Pressione di apertura: 0.02 bar

Può essere installata in qualsiasi posizione

Fluidi compatibili: acqua, olio, gasolio, aria  
e fluidi non aggressivi

*Threads: ISO 228*

*Max temperature of use: 90°C, peak 110°C*

*Opening pressure: 0.02 bar*

*It can be installed in any position*



*Fluids compatibles: water, oil, diesel, air  
and not aggressive fluids*

### Art.135/L

Valvola di fondo PN 10

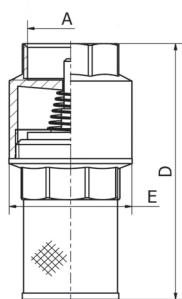
Foot valve PN 10



Misura	A	DN	D	E		
1/2"	1/2"	15	71,2	35,5		
3/4"	3/4"	20	78,3	41,7		
1"	1"	25	91,7	47,2	15	90
1.1/4"	1.1/4"	32	105,9	59,3	12	72
1.1/2"	1.1/2"	40	130,6	67,6	6	36
2"	2"	50	136,9	83,7	3	18
2.1/2"	2.1/2"	65	152,9	95		
3"	3"	80	170,4	110		
4"	4"	100	183,9	144		

Valvola di fondo con  
otturatore in ABS e guarnizione  
in NBR.

*Foot valve with shutter in  
ABS and NBR gasket.*

**Art.115**

Valvola di fondo "NEW" PN 25

Foot valve "NEW" PN 25



Valvola di fondo con otturatore in Nylon e guarnizione in NBR. Filtro Inox integrato nel corpo della valvola.

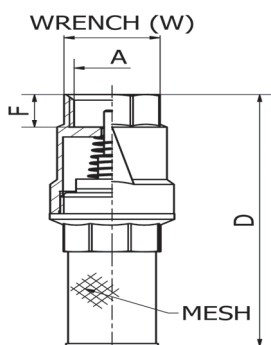

Foot valve with shutter in Nylon and NBR gasket. The S.S. filter is integrated into the valve's body.

Misura	A	F	W	Mesh	D	gr.	
1/2"	1/2"	13	24	1200µm	87,5	78	30
3/4"	3/4"	12	30	1200µm	95	116	20
1"	1"	13,5	37	1200µm	98,5	163	10
1.1/4"	1.1/4"	13	47	1200µm	116	244	7
1.1/2"	1.1/2"	16,5	51,5	1200µm	133	342	6
2"	2"	17	65	1200µm	148	519	3

**Stesse dimensioni, componenti e caratteristiche meccaniche dell'Art.135**

**Same dimensions, parts and mechanical specifics of Art.135**

**Art.135**

Valvola di fondo "JUPITER" PN 25

Foot valve "JUPITER" PN 25



Valvola di fondo con otturatore in Nylon e guarnizione in NBR. Filtro Inox integrato nel corpo della valvola.

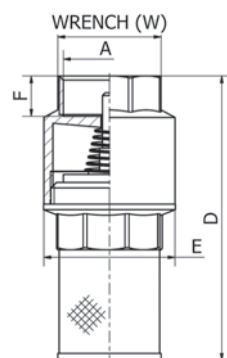

Foot valve with shutter in Nylon and NBR gasket. The S.S. filter is integrated into the valve's body.

Misura	A	F	W	Mesh	D	gr.	
1/2"	1/2"	13	24	1200µm	89	98	25
3/4"	3/4"	13	30	1200µm	96	148	10
1"	1"	14	37	1200µm	100	175	10
1.1/4"	1.1/4"	13	47	1200µm	113	285	7
1.1/2"	1.1/2"	16,5	52	1200µm	133	389	4
2"	2"	17	65	1200µm	147	556	3
2.1/2"	2.1/2"	16	81	1200µm	148	876	1
3"	3"	17	94,5	1200µm	178	1216	1
4"	4"	19,5	121	1200µm	200	1907	1

**Art.285**

Valvola di ritegno Art.150 + inox filter Art.235

Check valve Art.150 + stainless steel filter Art.235



Valvola di fondo con otturatore in Nylon e guarnizione in NBR. Filtro Inox svitabile. E' caratterizzata da basse perdite di carico grazie al passaggio maggiorato.

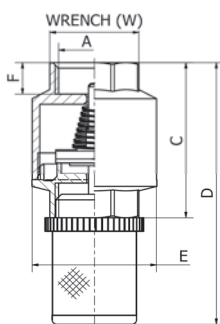

Foot valve with shutter in Nylon and NBR gasket. You can unscrew the S.S. filter. It has low loss of pressure thanks to full bore.

Misura	A	W	Mesh	C	D	gr.	
3/8"	3/8"	22	1200µm	52	104	185	15
1/2"	1/2"	26	1200µm	61	100	170	15
3/4"	3/4"	31	1200µm	57	113	260	15
1"	1"	38	1200µm	64,5	118	365	7
1.1/4"	1.1/4"	48	1200µm	68	132	567	5
1.1/2"	1.1/2"	55	1200µm	83	152	749	3
2"	2"	68	1200µm	90	173	1031	2
* 2.1/2"	2.1/2"	88	1200µm	119	204	2698	1
* 3"	3"	100	1200µm	138	230	4285	1
* 4"	4"	126	1200µm	157	259	6400	1

(\* ) = Con otturatore in ottone

(\* ) = With brass shutter

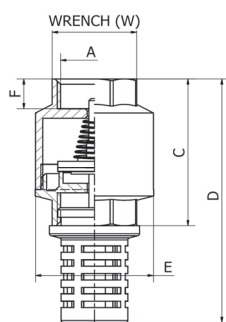
**Art.155**Valvola di ritegno Art.150+filtro Ottone Art.160 *Check valve Art.150 + Brass filter Art.160*

Valvola di fondo con otturatore in Nylon e guarnizione in NBR. Filtro in Ottone svitabile. E' caratterizzata da basse perdite di carico grazie al passaggio maggiorato.

*Foot valve with shutter in Nylon and NBR gasket. You can unscrew the Brass filter. It has low loss of pressure thanks to full bore.*

Misura / A	F	W	E	C	D	gr.	
1/2"	12	26	32	57	89	197	15
3/4"	15,5	31	42,5	64,5	105	302	15
1"	14	38	52,5	68	114	439	7
1.1/4"	13	48	62	74,5	117	647	5
1.1/2"	16	55	72	83	133	855	3
2"	19	67,5	82	90	152	1253	2
* 2.1/2"	21	88	118	119	200	3140	1
* 3"	30,5	100	139	138	235	4878	1
* 4"	34	126	153	157	262	7570	1

(\*) = Con otturatore in ottone

(\*) = With brass shutter

**Art.295**

Valvola di fondo in ottone stampato

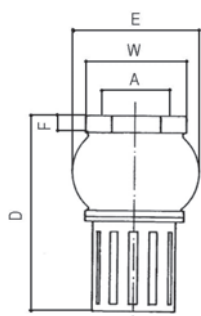
*Hot pressed Brass foot valve*

Valvola di fondo con otturatore in Ottone e guarnizione in gomma 75 SH. Finitura corpo sabbata. Installazione su tubazione verticale. Adatta anche per acque sporche. Filtro in Ottone svitabile.

*Foot valve with shutter in Brass and Rubber gasket 75 SH. Sand-blast finishing body. Fitting up to vertical pipe. It can be usable with dirty water. You can unscrew the Brass filter.*

Misura / A	F	W	E	D	gr.	
3/4"	10	34	45,5	74	247	10
1"	13,5	40	52	81	311	18
1.1/4"	15	49	61	95	400	4
1.1/2"	14	55	70	102	622	3
2"	14,5	69	78	116	1007	3
2.1/2"	11,5	83	103	136	1381	1
3"	15	95	116	150	2168	1
4"	22	123	145	185	3809	1
* 5"			180	239	6570	1
* 6"			201	267	9405	1

\* Valvola in Bronzo

\* Bronze Valve

**Art.296**

Valvola di fondo tubolare

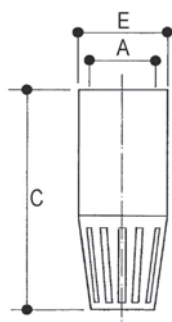
*Tubular foot valve*

Corpo, succheruola e otturatore in ottone DELTA CS. Guarnizione ottura. in gomma 75 SH. Finitura corpo tornita. Installazione su tubazione verticale. T max 80°C

*Brass DELTA CS body, strainer and disk. Rubber 75 SH disk gasket. Smoothly turned finishing. Fitting up to vertical pipe. T max 80 °C*

Misura	A	C	E	PN	gr.	
3/4"	3/4"	101	31	10	181	10
1"	1"	113	38	10	272	10
1.1/4"	1.1/4"	125	47	10	456	4
1.1/2"	1.1/2"	145	54	10	586	3
2"	2"	165	65	10	872	2
2.1/2"	2.1/2"	175	87	6	1510	1
3"	3"	195	99	6	631	1
4"	4"	220	121	6	3521	1

**Art.160** Filtro in Ottone

## Brass filter

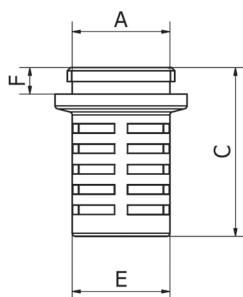

Misura	A	F	C	E	gr.		
1/2"	1/2"	8	39	20	36	30	30
3/4"	3/4"	9	48	25	50	25	25
* 1"	1"	9	54	30	89	15	15
1.1/4"	1.1/4"	9	51	40	127	12	12
1.1/2"	1.1/2"	9,5	57	46	157	15	15
2"	2"	10	71	56	242	8	8
2.1/2"	2.1/2"	15	96	68	566	5	5
3"	3"	16	112	78	651	3	3
4"	4"	17	122	98	1290	1	1

\* disponibile anche in alluminio ottonato giallo (Art. 160/A-1"- € 2,49)

**Art.235** Filtro Inox AISI 304L

## Stainless Steel AISI 304L filter

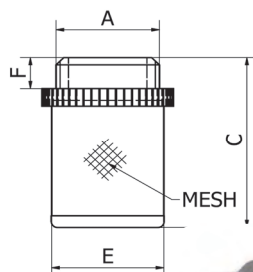

Misura	A	F	C	E	Mesh	gr.		
3/8"	3/8"	7	50	19	1200µm	9	10	1000
1/2"	1/2"	7,5	51	22	1200µm	12	10	320
3/4"	3/4"	8,5	57	28	1200µm	18	40	320
1"	1"	10	58	36	1200µm	31	28	336
1.1/4"	1.1/4"	11	68	43	1200µm	35	5	5
1.1/2"	1.1/2"	11	78	49	1200µm	43	5	5
2"	2"	12	95	61	1200µm	54	6	72
2.1/2"	2.1/2"	13	97	79	1200µm	105	1	36
3"	3"	13	105	90	1200µm	91	1	36
4"	4"	14	116	116	1200µm	212	1	36

**Art.235/A** Filtro Inos AISI 304L con asola

Misura	A	F	C	E	H	Mesh	gr.		
1"	1"	10	64	36	5	1200µm	21	24	240
1.1/4"	1.1/4"	11	75	45	6	1200µm	35	10	10

**Art.522** Filtro a setaccio M.M.

## Sieve filter M.M.



Misura	A	F	W	E	C	filtra	gr.		
3/4"	3/4"	13	23	83	45	400µm	269	15	120

Pressioni di esercizio : 100°C - PN 16 Working pressure : 100°C - PN 16  
120°C - PN 1 120°C - PN 10

**Art.520** Filtro a setaccio

## Sieve filter

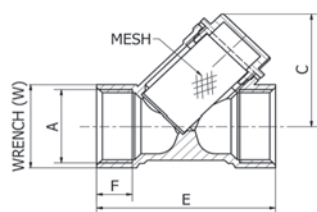

Misura	A	F	W	E	C	filtra	gr.		
1/4"	1/4"	13	21	56	40	400µm	117	36	216
3/8"	3/8"	10	20	46	39	400µm	100	36	216
1/2"	1/2"	10	24	56	38	400µm	123	48	192
3/4"	3/4"	11	30	68	48	400µm	200	24	96
1"	1"	14	38	77	55	400µm	271	18	72
1.1/4"	1.1/4"	18	48	95	67	500µm	527	8	32
1.1/2"	1.1/2"	19	53	105	74	500µm	653	6	24
2"	2"	20	66	125	90	500µm	1127	3	12
2.1/2"	2.1/2"	22	85	145	100	600µm	2064	2	8
3"	3"	24	96	165	118	600µm	2974	1	3
4"	4"	25	125	200	145	600µm	4311	1	3

Pressioni di esercizio :  
da 1/4" a 2": 100°C - PN 16  
120°C - PN 10  
da 2.1/2" a 3": 100°C - PN 10  
120°C - PN 6

Working pressure :  
from 1/4" to 2" : 100°C - PN 16  
120°C - PN 10  
from 2.1/2" to 3" : 100°C - PN 10  
120°C - PN 6

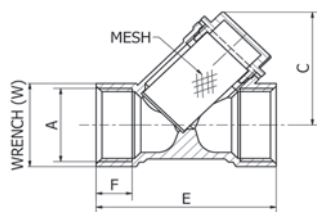
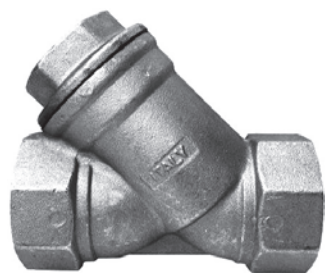

**Art.521**

Filtro a setaccio nichelato

*Sieve nickel plated filter*

Pressioni di esercizio:  
da 1/4" a 2": 100°C - PN 16  
120°C - PN 10  
da 2.1/2" a 3": 100°C - PN 10  
120°C - PN 6



*Working pressure :*  
*from 1/4" to 2" : 100°C - PN 16*  
*120°C - PN 10*  
*from 2.1/2" to 3" : 100°C - PN 10*  
*120°C - PN 6*

Misura	A	F	W	E	C	filtra gr.	gr.		
1/4"	1/4"	13	21	56	40	400µm	117	36	216
3/8"	3/8"	10	20	46	39	400µm	100	36	216
1/2"	1/2"	10	24	56	38	400µm	123	48	192
3/4"	3/4"	11	30	68	48	400µm	200	24	96
1"	1"	14	38	77	55	400µm	280	18	72
1.1/4"	1.1/4"	18	48	95	67	500µm	519	8	32
1.1/2"	1.1/2"	19	53	105	74	500µm	640	6	24
2"	2"	20	66	125	90	500µm	1100	3	12

**Art.520/M**

Filtro a setaccio M.F.

*Sieve filter M.F.*



Misura	A	F	W	E	C	filtra gr.	gr.		
1"	1"	15	38	75	45	400µm	278	13	78

**Art.524**

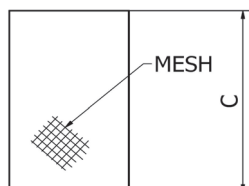
Filtro per Art.520 e Art.521

*Filter for Art.520 and Art.521*

Art.525 filtro per Art.522  
*Art.525 for Art.522*

Misura	filtra	ø	C		
1/4"	400µm	18	30	1	1
3/8"	400µm	18	30	1	1
1/2"	400µm	18	30	1	1
3/4"	400µm	24	40	1	1
1"	400µm	25	40	1	1
1.1/4"	500µm	35	47	1	1
1.1/2"	500µm	40	53	1	1
2"	500µm	42	67	1	1
2.1/2"	600µm	62	88	1	1
3"	600µm	95	115	1	1
4"	600µm			1	1

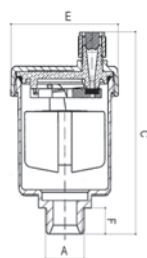

**Art.298**

Valvola automatica sfiato aria STANDARD



*STANDARD Automatic air-discharger valve*

Pressione max.: PN 10  
Temperatura massima: 110°C  
Fluidi compatibili: acqua

*Max pressure : PN 10*  
*Temperature max.: 110°C*  
*Compatible fluids: water*

Misura	A	F	E	C	gr.		
3/8"	3/8"	8,5	37	80	118	25	200
1/2"	1/2"	8,5	37	80	119	25	200

**Art.298/N** Cromata / *Chromium plated*

Misura	A	F	E	C	gr.		
3/8"	3/8"	8,5	37	80	118	25	200
1/2"	1/2"	8,5	37	80	119	25	200

**Art.297**

Valvola automatica sfiato aria MEDIA

MEDIUM Automatic air-discharger valve

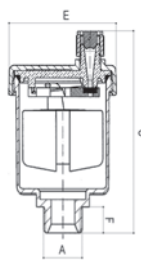

Misura	A	F	E	C	gr.		
3/8"	3/8"	8,5	41	76	139	10	100
1/2"	1/2"	8,5	41	76	140	10	100

Pressione max.: PN 10  
 Temperatura massima: 110°C  
 Fluidi compatibili: acqua

Max pressure : PN 10  
 Temperature max.: 110°C  
 Compatible fluids: water

**Art.286**

Valvola automatica di sfiato aria PESANTE

HEAVY Automatic air-discharger valve

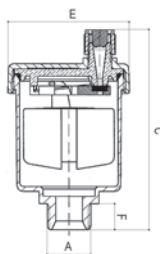

Misura	A	F	E	C	gr.		
3/8"	3/8"	10	50	82	174	10	100
1/2"	1/2"	10	50	82	180	10	100

**Art.286/N** Cromata / Chromium plated

Misura	A	F	E	C	gr.		
3/8"	3/8"	10	50	82	174	10	100
1/2"	1/2"	10	50	82	180	10	100

Pressione max.: PN 12  
 Temperatura massima: 110°C  
 Fluidi compatibili: acqua

Max pressure : PN 12  
 Temperature max.: 110°C  
 Compatible fluids: water

**Art.286/S**

Solar per impianti solari

Solar for solar system

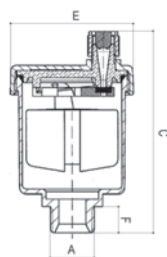

Misura	A	F	E	C	gr.		
3/8"	3/8"	10	50	82	174	10	100
1/2"	1/2"	10	50	82	180	10	100

**Art.286/SN** Cromata / Chromium plated

Misura	A	F	E	C	gr.		
3/8"	3/8"	10	50	82	174	10	100
1/2"	1/2"	10	50	82	180	10	100

Pressione max.: PN 10  
 Temperatura massima: 180°C  
 Fluidi compatibili: acqua

Max pressure : PN 10  
 Temperature max.: 180°C  
 Compatible fluids: water

**Art.220**

Valvola automatica sfiato aria, MAXI

Automatic air-discharger valve, MAXI

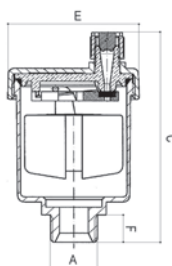

Misura	A	F	E	C	gr.		
1/2"	1/2"	10	50	105	256	10	10
3/4"	3/4"	10	50	105	259	10	10
1"	1"	10	50	105	258	10	10

**Art.220/N** Cromata / Chromium plated

Misura	A	F	E	C	gr.		
1/2"	1/2"	10	50	105	256	10	10
3/4"	3/4"	10	50	105	259	10	10
1"	1"	10	50	105	258	10	10

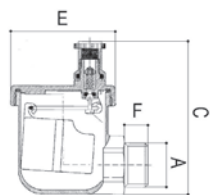

Pressione max.: PN 12  
 Temperatura massima: 110°C  
 Fluidi compatibili: acqua

Max pressure : PN 12  
 Temperature max.: 110°C  
 Compatible fluids: water



**Art.299**Valvola automatica sfiato aria, attacco 90° *Standard Automatic air-discharger valve*

Pressione max.: PN 10  
 Temperatura massima: 110°C  
 Fluidi compatibili: acqua  
 Attacco ad angolo

Max pressure : PN 10  
 Temperature max.: 110°C  
 Compatible fluids: water  
 Lateral attack

Misura	A	F	E	C	gr.		
3/8"	3/8"	8,5	42	61	121	10	10
1/2"	1/2"	8,5	42	61	119	10	10

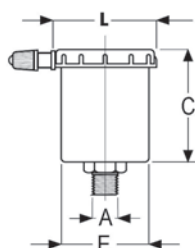

**Art.299/N** Cromata / Chromium plated

Misura	A	F	E	C	gr.		
3/8"	3/8"	8,5	42	61	190	10	10
1/2"	1/2"	8,5	42	61	196	10	10



**Art.221**Valvola automatica sfiato aria laterale *Automatic side air-discharger valve*

Pressione max.: PN 10  
 Temperatura massima: 110°C  
 Fluidi compatibili: acqua

Max pressure : PN 10  
 Temperature max.: 110°C  
 Compatible fluids: water

Misura	A	C	E	L	gr.		
3/8"	3/8"	49	38	44	150	16	160
1/2"	1/2"	49	38	44	157	16	160

**Art.221/N** Cromata / Chromium plated

Misura	A	C	E	L	gr.		
3/8"	3/8"	49	38	44	150	16	160
1/2"	1/2"	49	38	44	157	16	160

**Art.645**Valvola di ritegno per valvola sfiato aria *Check valve for air valve*

Valvola di intercettazione automatica.  
 Temperatura massima : 80°C  
 PN 10

Interception valve.  
 Maximum temperature: 80°C  
 PN 10

Misura	A	A1	F	W	D	gr.		
3/8" x 3/8"	3/8"	3/8"	9	19	32	26	10	10
3/8" x 1/2"	3/8"	1/2"	12	19	32	37	10	10
1/2" x 1/2"	1/2"	1/2"	12	19	32	37	10	10

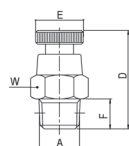

**Art.645/S** prezzi su richiesta / prices on request

Valvola di ritegno per valvola automatica per impianti solari  
 Check valve for automatic valve for solar system

**Art.640**Valvolina sfiato aria con volantino in ottone *Air valve with brass handwheel*

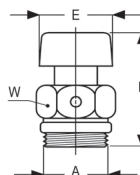
Misura	A	F	W	E	D	gr.		
1/8"	1/8"	7,5	11	13	25	14	100	100
1/4"	1/4"	7,5	14	12	24	21	100	100
3/8"	3/8"	7	17	13	27	34	100	100

**Art.640/T**Valvolina sfiato aria con anello in teflon *Air valve with teflon ring*

Misura	A	W	E	D	gr.		
1/4"	1/4"	13	18	28	21	100	100
3/8"	3/8"	17	18	28	34	100	100
1/2"	1/2"	21	18	28	49	75	75

**Art.642**

Valvolina di scarico orientabile

*Mini drain-off valves*

Misura	A		
1/4"	1/4"	100	100
3/8"	3/8"	100	100

**Art.643**

Rubinetto di scarico

*Drain cock*

Misura	A	gr.		
1/4"	1/4"	43	100	100

**Art.448/S**

Valvola girevole a 90° M.F.

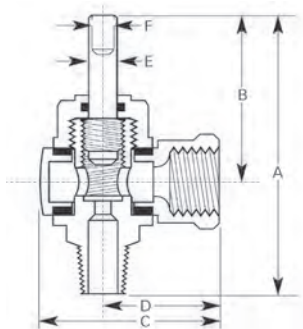
*Swivel Valve 90° M.F.*

Misura	A1	A2	B1	B2	C	D	E	F	
1/2"	108	92	58	42	78	54	11	10	2
3/4"	105	90	58	42	85	68	11	10	2
1"	116	97	65	46	100	45	16	13	2

A1/B1 : OPEN

A2/B2 : CLOSE

**Art.448**

Valvola a 90° M.F. lucchettabile

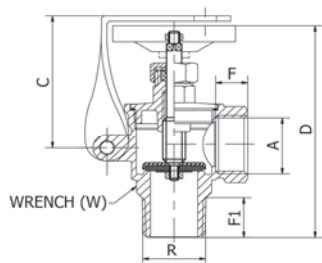
*Valve 90° M/F with lockable wheel handle*

Misura/A	F	R	F1	W	C	D	gr.		
1"	16,5	1"	22	34	78	126	626	2	2



 Volantino a razze  
per una presa migliore

Corpo, disco, tappo in ottone CW617N  
Asta e vitone in ottone CW614N  
Volantino in alluminio plastificato con  
resina epossidica rossa.

*Body, disk, bonnet in CW617N  
Arm and auger in CW614N  
Handwheel in plasticized  
aluminium*

**Art.446**

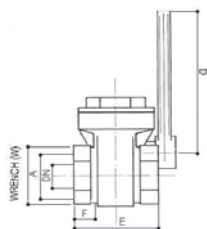
Saracinesca in bronzo

*Quick opening bronze gatevalve*

Misura	A	F	W	E	D	DN	gr.		
3/8"	3/8"	9	24	44	80	15	368	2	2
1/2"	1/2"	10	27	46	80	15	356	2	2
3/4"	3/4"	10	35	51	100	20	550	2	2
1"	1"	12	41	57	100	25	766	1	1
1.1/4"	1.1/4"	14	51	61	120	32	1002	1	1
1.1/2"	1.1/2"	15	57	67	137	37	1432	1	1
2"	2"	16	69	77	165	47	2080	1	1
2.1/2"	2.1/2"	16	88	86	205	58	3507	1	1
3"	3"	18	98	91	205	72	4314	1	1
4"	4"	20	125	102	205	92	7480	1	1

Corpo in bronzo, tappo, disco in ottone  
Leva in alluminio plastificato  
Pressione di esercizio alla max  
temperatura 80°C: PN 10 da 3/8" a 2"  
PN 6 da 2.1/2" a 3"

*Body in bronze, bonnet and disk  
in brass. Lever in Alu. plasticized  
Working pressure at maximum  
temperature 80°C: from 3/8" to 2": PN 10  
from 2.1/2" to 3": PN 6*



**Art.445** Saracinesca PN 12

*Gatevalve PN 12*

Volantino a razze  
per una migliore  
presa

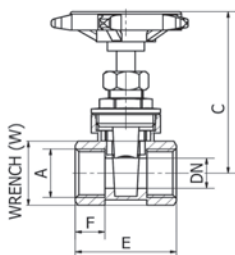

Corpo, disco, tappo in ottone CW617N  
Asta e vitone in ottone CW614N  
Volantino in alluminio plastificato con  
resina epossidica rossa.

*Body, disk, bonnet in CW617N  
Arm and auger in CW614N  
Handwheel in aluminium*

Misura	A	F	W	E	C	DN	gr.		
1/4"	1/4"	13	24	35	66	11	162	25	25
3/8"	3/8"	12	24	36	67	13	164	25	25
1/2"	1/2"	12	24	41	67	13	160	16	160
3/4"	3/4"	13	30	44	72	15	203	12	120
1"	1"	13	37	47	79	20	276	7	84
1.1/4"	1.1/4"	15	44	52	89	27	437	5	50
1.1/2"	1.1/2"	18	53	59	108	33	632	3	36
2"	2"	18	65	63	134	42	1015	2	24

**Art.447** Saracinesca PN 16

*Gatevalve PN 16*

Volantino a razze  
per una migliore  
presa

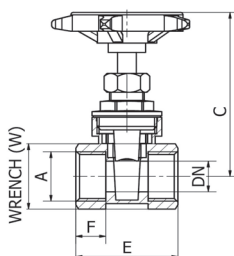

Corpo, disco, tappo in ottone CW617N  
Asta e vitone in ottone CW614N  
Volantino in alluminio plastificato con  
resina epossidica rossa.

*Body, disk, bonnet in CW617N  
Arm and auger in CW614N  
Handwheel in aluminium*

Misura	A	F	W	E	C	DN	gr.		
1/2"	1/2"	10	25	37	69	15	185	10	120
3/4"	3/4"	11	32	41	79	19	255	10	100
1"	1"	12	38	46	93	24	390	6	60
1.1/4"	1.1/4"	14	46	53	106	32	580	4	40
1.1/2"	1.1/2"	14	52	56	119	37	750	3	30
2"	2"	16	65	66	143	49	1280	2	20
2.1/2"	2.1/2"	15	81	62	166	59	1700	2	12
3"	3"	15	93	74	202	71	2250	1	6
3.1/2"	3.1/2"							1	1
4"	4"	20	122	85	230	91	4200	1	4

**Art.450** Saracinesca PN 20, PESANTE

*Gatevalve PN 20, HEAVY*

Volantino a razze  
per una migliore  
presa

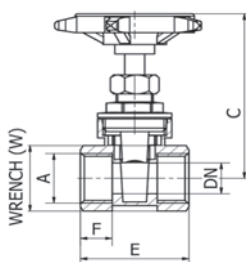

Corpo, disco, tappo in ottone CW617N  
Asta e vitone in ottone CW614N  
Volantino in alluminio plastificato con  
resina epossidica rossa.

*Body, disk, bonnet in CW617N  
Arm and auger in CW614N  
Handwheel in aluminium*

Misura	A	F	W	E	C	DN	gr.		
1/4"	1/4"	13	24	35	66	11	162	25	25
3/8"	3/8"	12	24	36	67	13	164	20	160
1/2"	1/2"	13	26	44	68	15	210	18	108
3/4"	3/4"	15	32	50	79	19	280	10	80
1"	1"	15	40	54	93	25	430	5	50
1.1/4"	1.1/4"	17	48	58	106	32	695	4	40
1.1/2"	1.1/2"	18	52	63	119	37	790	2	24
2"	2"	20	67	70	143	47	1430	2	16
2.1/2"	2.1/2"	20	81	76	177	60	2046	2	8
3"	3"	21	94	83	205	71	3060	1	6
4"	4"	23	122	92	236	91	5000	1	4
5"	5"	25	149	113	306	111	10 kg	1	2
6"	6"	25	175	120	333	135	14 kg	1	2

**Art.447/S** Saracinesca PN16 con rubinetto di spurgo

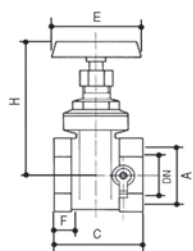
*Gate valve PN 16 with drain cock*

Corpo, disco, tappo in ottone CW617N  
Asta e vitone in ottone CW614N  
Volantino in acciaio plastificato con  
resina epossidica rossa.

*Body, disk, bonnet in CW617N  
Arm and auger in CW614N  
Handwheel in plasticized stainless steel*

Misura	A	DN	F	E	C	H	gr.		
1"	1"	73	82	65	12	60	431	7	7

ALTRE MISURE DISPONIBILI SU RICHIESTA  
OTHER SIZES AVAILABLES ON REQUEST

Doppia uscita laterale (tappo/spurgo)  
Connection at both sides (plug/discharge)

**Art.449** Rubinetto a sfera idrante con portagomma *Ball fireplug cock with hose connector*

 Modello PESANTE  
*HEAVY type*

Misura	A	E	C	D	gr.		
1/2"	1/2"	15	106	76	280	8	80
3/4"	3/4"	20	106	92	401	1	1
1"	1"	26	106	115	611	1	1

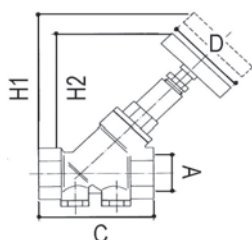
**Art.441** Valvola a flusso avviato in bronzo *Bronze free flow globe valve*

Misura	A	C	D	H1	H2		
1/2"	1/2"	65	50	98	85	1	1
3/4"	3/4"	75	55	112	98	1	1
1"	1"	90	60	130	113	1	1
1.1/4"	1.1/4"	110	70	155	135	1	1
1.1/2"	1.1/2"	120	80	185	155	1	1
2"	2"	150	100	225	190	1	1

 Otturatore in gomma 70 SH  
 Molla in AISI 304  
 Tappo di scarico a monte e a valle 1/4"

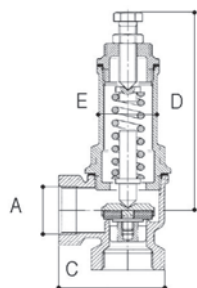
*70 SH rubber disk gasket*  
*Spring in AISI 304*  
*1/4" plug upstream and downstream*
**Art.464** Valvola limitatrice di pressione *Safety valve conveyed discharge*

Misura	A	E	C	D	gr.		
3/8"	3/8"	24	46	91	300	1	1
1/2"	1/2"	25	56	125	375	1	1
3/4"	3/4"	30	64	117	622	1	1
1"	1"	32	76	123	875	1	1
1.1/4"	1.1/4"	40	90	148	1450	1	1
1.1/2"	1.1/2"	43	100	171	1900	1	1
2"	2"	51	124	187	2900	1	1
2.1/2"	2.1/2"	147	230	6000	6000	1	1
3"	3"	155	250	7600	7600	1	1

 Con sede in ottone (max T: 200°C)  
 Tarabile da 0 a 16 bar  
 Scarico convogliato

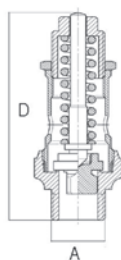
*With brass seat (max T: 200°C)*  
*To set from 0 to 16 bar*
**Disponibile con sede in SBR (gomma Art.464/G max T: 90°C)**  
**o con sede Teflon (Art.464/T max T: 180°C) + 10%**  
*Available also with rubber seat (Art.464/G max T: 90°C)*  
*or teflon seat (Art.464/T max T: 180°C) + 10%*
**Art.469** Valvola limitatrice di pressione *Free discharge safety valve*



Misura	A	D	gr.		
1/4"	1/4"	24	145	1	1
3/8"	3/8"	30	150	1	1
1/2"	1/2"	85	151	1	1
3/4"	3/4"	104	372	1	1
1"	1"	118	550	1	1
1.1/4"	1.1/4"	136	1033	1	1
1.1/2"	1.1/2"	145	1319	1	1
2"	2"	167	1967	1	1

 Con sede in ottone (max 200 °C)  
 Tarabile da 0 a 16 bar  
 Disponibili certificazioni

*With brass seat (max T: 200°C)*  
*To set from 0 to 16 bar*  
**Available certification**
**Disponibile anche con sede in SBR(gomma Art.469/G max T: 90°C)**  
**o con sede Teflon (Art.469/T max T: 180°C) + 10%**  
*Available also with rubber seat (Art.469/G max T: 90°C)*  
*or teflon seat (Art.469/T max T: 180°C) + 10%*

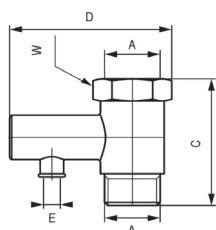
**Art.467** Valvola di sicurezza per scaldabagni



*Safety valve for water heater*

Misura	A	W	E	C	D	gr.		
1/2"	1/2"	25	6	48	40	70	24	240
3/4"	3/4"	32	9	56	70	192	5	5

 Tarate a 8 bar  
 (altre tarature su richiesta)

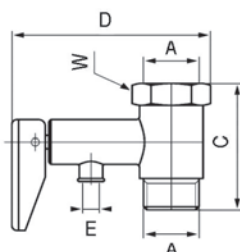
*Setting 8 bar  
 (other settings on request)*
**Art.468** Valvola di sicurezza per scaldabagni



*Safety valve for water heater*

Misura	A	W	E	C	D	gr.		
1/2"	1/2"	25	6	60	40	72	24	240
3/4"	3/4"	32	9	56	70	196	5	5

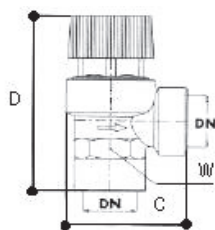

 Con leva  
 Tarate a 8 bar  
 (altre tarature su richiesta)

*With arm  
 Setting 8 bar  
 (other settings on request)*
**Art.820** Valvola di sicurezza F.F. a membrana

*Safety valve F.F. with plastic insert*

**TARATURE DA 1 A 6 BAR**



Misura	A	DN	W	C	D	gr.		
1/2" x 1/2"	1/2"	13	25	42	66	116	10	10
3/4" x 3/4"	3/4"	13	31	47	71	191	10	10
1" x 1"	1"	17	38	53	77	200	6	6

**TARATURE DA 7 A 10 BAR**

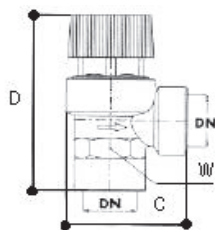
Misura	A	DN	W	C	D	gr.		
1/2" x 1/2"	1/2"	13	25	42	66	116	10	10
3/4" x 3/4"	3/4"	13	31	47	71	191	10	10
1" x 1"	1"	17	38	53	77	200	6	6

**Art.820/S** Valvola di sicurezza F.F. a membrana

*Safety valve F.F. with plastic insert*

**TARATURE DA 2,5 A 10 BAR**

Misura	DN1	DN		
1/2" x 3/4"	3/4"	1/2"	10	10

**USO SOLARE**
**FOR SOLAR USE**

**Art.825**

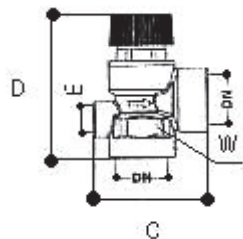
Valvola di sicurezza F.F. a membrana

*Safety valve F.F. with plastic insert*

**TARATURE DA 1 A 6 BAR**

Misura	A	DN	W	C	D	gr.		
1/2" x 1/2"	1/2"	13	25	42	66	142	10	10
3/4" x 3/4"	3/4"	13	31	47	71	180	10	10

**TARATURE DA 7 A 10 BAR**

Misura	A	DN	W	C	D	gr.		
1/2" x 1/2"	1/2"	13	25	42	66	142	10	10
3/4" x 3/4"	3/4"	13	31	47	71	180	10	10

 Con attacco manometro 1/4" *With manometer connection 1/4"*
**Art.830**

Valvola di sicurezza M.F. a membrana

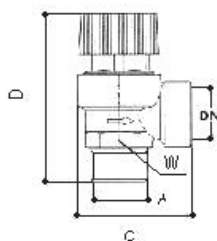
*Safety valve M.F. with plastic insert*

**TARATURE DA 1 A 6 BAR**

Misura	A	DN	W	C	D	gr.		
1/2" x 1/2"	1/2"	13	25	42	66	117	10	10
3/4" x 3/4"	3/4"	13	31	47	71	193	10	10

**TARATURE DA 7 A 10 BAR**

Misura	A	DN	W	C	D	gr.		
1/2" x 1/2"	1/2"	13	25	42	66	117	10	10
3/4" x 3/4"	3/4"	13	31	47	71	193	10	10

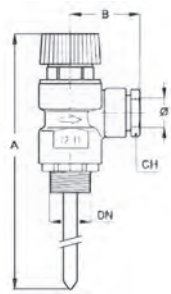
**Art.830/T**

 Valvola di sicurezza M.F. doppia funzione T- *Safety valve M.F. double function T-P*

**TARATURE DA 3 A 8 BAR**

Misura	DN	A	B	CH		
1/2"x1/2"	1/2"	180	35	21	24	
3/4"x1/2"		180	35	21	24	
3/4"x3/4"	3/4"	180	35	21	24	

 Temperatura : 90°C  
 Pressione nominale : PN 10  
 Potenzialità di carico : 1/2" e 3/4" 10 kW  
 Fluido: acqua

*Temperature : 90°C  
 Nominal pressure : PN 10  
 Discharge rating : 1/2" and 3/4" 10 kW  
 Fluid : acqua*
**Art.835**

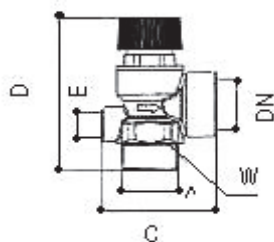
Valvola di sicurezza M.F. a membrana

*Safety valve M.F. with plastic insert*

**TARATURE DA 1 A 6 BAR**

Misura	A	DN	W	C	D	gr.		
1/2" x 1/2"	1/2"	13	25	42	66	137	10	10
3/4" x 3/4"	3/4"	13	31	47	71	182	10	10

**TARATURE DA 7 A 10 BAR**

Misura	A	DN	W	C	D	gr.		
1/2" x 1/2"	1/2"	13	25	42	66	137	10	10
3/4" x 3/4"	3/4"	13	31	47	71	182	10	10

 Con attacco manometro 1/4" *With manometer connection 1/4"*

**Art.475** Rubinetto sfera scarico caldaia M.

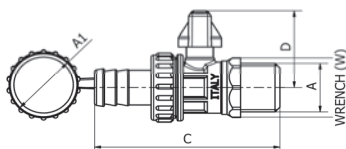

*Ball valve boiler discharge M.*

Misura	A	A1	W	C	D	gr.		
3/8"	3/8"	3/4"				100	10	120
1/2"	1/2"	3/4"	24	76	35	101	10	120
3/4"	3/4"	3/4"	28	67	38	151	10	10

Corpo in ottone CW617N giallo *Body in CW617N, yellow*  
 Leva in Alluminio rossa *Arm in red Aluminium*  
 Girello e portagom. in ottone CW617N *Ring nut and hose connector in CW617N*  
 Catenella in gomma. Guarnizione *Chain in NBR. Gasket*  
 Pressione di esercizio 16 bar *Working pressure : 16 bar*  
 Massima temperatura 90°C *Maximum temperature 90°C*

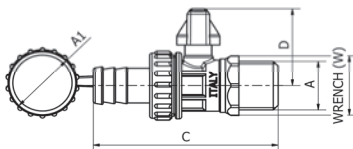
**Art.475/N** Rubinetto sfera scarico caldaia M.

*Ball valve boiler discharge M.*



Misura	A	A1	W	C	D	gr.		
1/2"	1/2"	3/4"	26	67	35	101	10	120

Corpo in ottone CW617N giallo *Body in CW617N, yellow*  
 Leva in Alluminio nera *Arm in black Aluminium*  
 Girello e portagom. in ottone CW617N *Ring nut and hose connector in CW617N*  
 Catenella in NBR. Guarnizione *Chain in NBR. Gasket*  
 Pressione di esercizio 16 bar *Working pressure : 16 bar*  
 Massima temperatura 90°C *Maximum temperature 90°C*

**477/N** rubinetto sfera scarico caldaia nichelata +10%  
*ball valve boiler discharge nickel plated +10%*

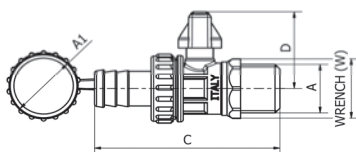
**Art.475/T** Rubin. scarico M. con anello in Teflon



*Ball valve boiler discharge M. with teflon ring*

Misura	A	A1	W	C	D	gr.		
1/2"	1/2"	3/4"	24	76	35	101	10	120

Corpo in ottone CW617N giallo *Body in CW617N, yellow*  
 Leva in Alluminio rossa *Arm in red Aluminium*  
 Girello e portagom. in ottone CW617N *Ring nut and hose connector in CW617N*  
 Catenella in gomma. Guarnizione *Chain in NBR. Gasket*  
 Pressione di esercizio 16 bar *Working pressure : 16 bar*  
 Massima temperatura 90°C *Maximum temperature 90°C*  
 Anello in teflon *Ring in Teflon*

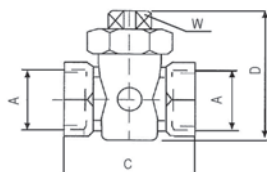
**Art.476** Rubinetto a maschio F.F.

*Plug valve F.F.*

Misura	A	W	C	D	gr.		
3/8"	3/8"	10	40	41	105	10	10
1/2"	1/2"	12	45	46	109	10	10
3/4"	3/4"	14	56	56	190	5	5

**Art.1** Rubinetto a maschio M.F.

Misura	A	W	C	D	gr.		
1.1/4"	1.1/4"	10	40	41	570	6	48

Altre misure su richiesta  
Other sizes on request

**Art.435** Valvola clapet SEDE METALLO PN 25

 Swing check valve **METAL SEAT PN 25**

Misura	A	F	W	E	C	gr.		
3/8"	3/8"	12	25	47	33	155	10	10
1/2"	1/2"	12	25	47	33	143	25	25
3/4"	3/4"	12	30	52	36	217	16	16
1"	1"	13	38	64	40	331	7	42
1.1/4"	1.1/4"	14	47	75	45	448	6	36
1.1/2"	1.1/2"	18	54	86	55	731	3	18
2"	2"	16	67	97	158	1040	4	4
2.1/2"	2.1/2"	19	82	116	62	1480	1	1
3"	3"	20	97	137	74	2410	1	1
4"	4"	21	122	165	95	3950	1	1
5"	5"						1	1
6"	6"						1	1

Corpo, tappo e otturatore in CW617N  
Sede metallica  
Installazione su tubazione orizzontale

Body, bonnet, shutter in CW617N  
Metallic seat  
Installation on horizontal pipe

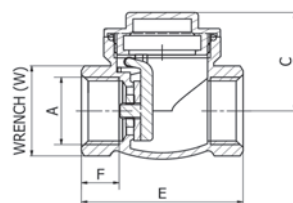

**Art.440** Valvola clapet SEDE GOMMA PN 25

 Swing check valve **RUBBER SEAT PN 25**

Misura	A	F	W	E	C	gr.		
3/8"	3/8"	12	25	47	33	155	10	10
1/2"	1/2"	12	25	47	33	143	20	160
3/4"	3/4"	12	30	52	36	217	10	80
1"	1"	13	38	64	40	331	8	64
1.1/4"	1.1/4"	14	47	75	45	448	6	36
1.1/2"	1.1/2"	18	54	86	55	731	4	24
2"	2"	16	67	97	158	1040	3	18
2.1/2"	2.1/2"	19	82	116	62	1480	2	8
3"	3"	20	97	137	74	2410	1	1
4"	4"	21	122	165	95	3950	1	1

Corpo, tappo e battente in ottone  
Sede gomma NBR  
Installazione su tubazione orizzontale

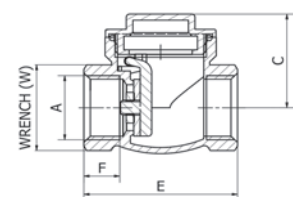
Body, bonnet, shutter in CW617N  
Rubber seat  
Installation on horizontal pipe



**Art.730** Filtro autopulente F.F. PN 25

Self-cleaning filter F.F.

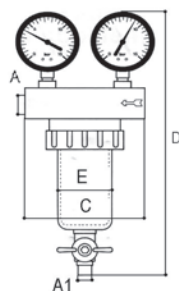



Cartuccia in acciaio inox, filtro **300 µm**  
 2 manometri: uno in ingresso  
 e uno in uscita  
 Rubinetto di scarico, attacchi  
 filettati F.F. Nichelato  
 Temperatura massima: 130°C

*Stainless steel 300µm cartridge*  
*2 manometers: one incoming and*  
*1 outgoing*  
*Drain cock, female attack*  
*Maximum temperature: 130°C*  
*Nickel plated*

Misura	A	A1	E	C	D	bar	gr.		
1/2"	1/2"	3/8"	58	118	198	0-16	1668	1	1
3/4"	3/4"	3/8"	58	118	198	0-16	1627	1	1
1"	1"	3/8"	58	126	217	0-16	2211	1	1
1.1/4"	1.1/4"	3/8"	58	126	217	0-16	2120	1	1
1.1/2"	1.1/2"	3/8"	58	153	255	0-16	3343	1	1
2"	2"	3/8"	58	154	255	0-16	3117	1	1

**Art.725** Disponibile senza manometri  
 Available without pressure gauges

Misura	A	A1	E	C	D	bar	gr.		
1/2"	1/2"	3/8"	58	118	198	0-16	1668	1	1
3/4"	3/4"	3/8"	58	118	198	0-16	1627	1	1
1"	1"	3/8"	58	126	217	0-16	2211	1	1
1.1/4"	1.1/4"	3/8"	58	126	217	0-16	2120	1	1
1.1/2"	1.1/2"	3/8"	58	153	255	0-16	3343	1	1
2"	2"	3/8"	58	154	255	0-16	3117	1	1

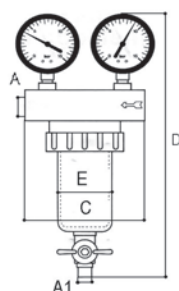

**Art.740** Filtro autopulente F.F. PN 25

Self-cleaning filter F.F.





Cartuccia in acciaio inox, filtro **100 µm**  
 2 manometri: uno in ingresso  
 e uno in uscita  
 Rubinetto di scarico, attacchi  
 filettati F.F. Nichelato  
 Temperatura massima: 130°C

*Stainless steel 100µm cartridge*  
*2 manometers: one incoming and*  
*1 outgoing*  
*Drain cock, female attack*  
*Maximum temperature: 130°C*  
*Nickel plated*

Misura	A	A1	E	C	D	bar	gr.		
1/2"	1/2"	3/8"	58	118	198	0-16	1668	1	1
3/4"	3/4"	3/8"	58	118	198	0-16	1627	1	1
1"	1"	3/8"	58	126	217	0-16	2211	1	1
1.1/4"	1.1/4"	3/8"	58	126	217	0-16	2120	1	1
1.1/2"	1.1/2"	3/8"	58	153	255	0-16	3343	1	1
2"	2"	3/8"	58	154	255	0-16	3117	1	1

**Art.735** Disponibile senza manometri  
 Available without pressure gauges

Misura	A	A1	E	C	D	bar	gr.		
1/2"	1/2"	3/8"	58	118	198	0-16	1668	1	1
3/4"	3/4"	3/8"	58	118	198	0-16	1627	1	1
1"	1"	3/8"	58	126	217	0-16	2211	1	1
1.1/4"	1.1/4"	3/8"	58	126	217	0-16	2120	1	1
1.1/2"	1.1/2"	3/8"	58	153	255	0-16	3343	1	1
2"	2"	3/8"	58	154	255	0-16	3117	1	1

**Art.745** Cartuccia filtro inox

Stainless steel filter cartridge

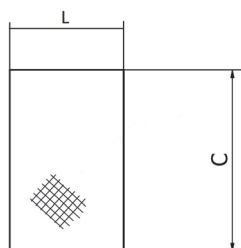

Cartuccia di ricambio per Art.725 -  
 Art.730 - Art.735 - Art.740  
 Filtrazioni : 100 µm e 300 µm

*Stainless steel cartridge*  
*for Art.725 - Art.730 - Art.735*  
*Art.740. Filtering: 100/300 µm*

Misura	µm	C	L		
1/2"	100µm	100	33	1	1
3/4"	100µm	100	33	1	1
1"	100µm	108	40	1	1
1.1/4"	100µm	108	40	1	1
1.1/2"	100µm	123	44	1	1
2"	100µm	123	44	1	1
1/2"	300µm	100	33	1	1
3/4"	300µm	100	33	1	1
1"	300µm	108	40	1	1
1.1/4"	300µm	108	40	1	1
1.1/2"	300µm	123	44	1	1
2"	300µm	123	44	1	1

**Art.726** Filtro con bocchettone M.M.

*Filter with union M.M.*

Misura	A	gr.		
3/4"	3/4"	800	1	1
1"	1"	885	1	1

Con bocchettone M.M.  
With union M.M.

**Art.721** Riduttore di pressione + Filtro laterale

*Side pressure-reducer + filter*

Misura	A	gr.		
3/4"	3/4"	2240	1	1
1"	1"	2450	1	1

Con bocchettone M.M.  
With union M.M.

PN 16

Uscita da 1,5 a 6 bar  
Outlet from 1,5 to 6 bar

**Art.706** Riduttore di pressione PN 16

*Pressure - Reducer PN 16*

Misura	A	gr.		
3/4"	3/4"	1045	1	1
1"	1"	1235	1	1

Con bocchettone M.M.  
With union M.M.

Uscita da 1,5 a 6 bar  
Outlet from 1,5 to 6 bar

**Art.722** Riduttore di pressione + Filtro PN 16

*Pressure reducer + filter PN 16*

Misura	A	gr.		
3/4"	3/4"	1470	1	1
1"	1"	1660	1	1

Con bocchettone M.M.  
With union M.M.

Uscita da 1,5 a 6 bar  
Outlet from 1,5 to 6 bar

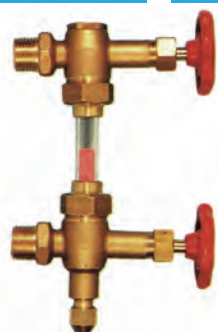

**Art.780** Indicatore di livello tenuta a spillo PN 10 *Level indicator pin seal PN 10*

Misura	gr.		
1/2"x ø13	662	1	1
1/2"x ø16	629	1	1

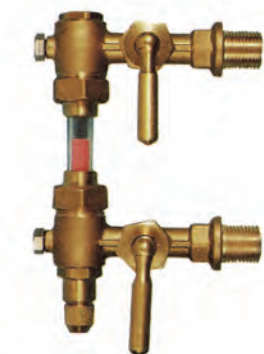
**Art.790** Indicatore di livello tenuta a maschio PN 25 *Level indicator male seal PN 25*

Misura	gr.		
1/2"x ø13	870	1	1

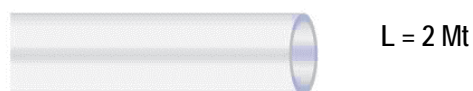
**Art.781** Tubo da 2 Mt per indicatore di livello *Tube of 2 Mt for level indicator*

Misura	Lunghezza / Length		
1/2"x ø13	2 Mt	1	1
1/2"x ø16	2 Mt	1	1

Prezzo al metro

**Art.749** Micro-regolatore

*Micro-regulator*

Misura	A	gr.		
1/4"	1/4"	65	25	400

**Art.772** Valvola a pulsante

*Pushbutton brass valve*

Misura		
3/8"	1	1

## RIDUTTORI DI PRESSIONE

*Water pressure reducers*

**Art.700**

Riduttore di pressione F.F. PN 30

*Water pressure reducer F.F. PN 30*



Riduttore di pressione a pistone in CW617N  
 sede e asta in acciaio inox  
 Attacchi per manometro  
 su i due lati  
 Attacchi con raccordi F.F.  
 Pressione in uscita: 0,5 - 7 bar  
 Temperatura massima  
 di esercizio: 80°C

*Pressure reducer in CW617N  
 Seat and arm in Stainless Steel  
 Manometer attack on 2 sides  
 Attack with female connector  
 Outgoing pressure: 0,5 - 7 bar  
 Maximum temperature: 80°C*

Misura	A	C1	C	D	PN	gr.		
1/2"	1/2"	75	115	147	30	1045	1	1
3/4"	3/4"	88	132	172	30	1660	1	1
1"	1"	93	143	178	30	1974	1	1
1.1/4"	1.1/4"	110	170	220	25	2872	1	1
1.1/2"	1.1/2"	110	175	220	25	3345	1	1
2"	2"	130	200	250	25	4810	1	1

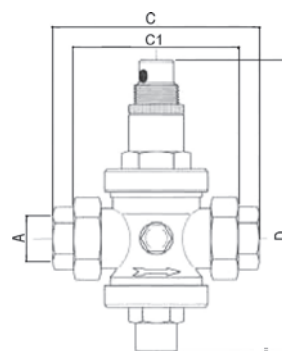

Misure per alta pressione :  
 1/2", 3/4", 1"

*Sizes for high pressure :*  
 1/2", 3/4", 1"

**Art.705**

Riduttore di pressione M.M. PN 25

*Water pressure reducer M.M. PN 25*



Riduttore di pressione a pistone in CW617N  
 sede e asta in acciaio inox  
 Attacchi per manometro su due lati  
 Attacchi con raccordi M.M.  
 Pressione in uscita: 0,5 - 6 bar  
 Temp. max di esercizio: 80°C

*Pressure reducer in CW617N  
 Seat and arm in Stainless Steel  
 Manometer attack on 2 sides  
 Attack with male connector  
 Outgoing pressure: 0,5 - 6 bar  
 Maximum temperature: 80°C*

Misura	A	C1	C	D	PN	gr.		
1/2"	1/2"	75	112	120	25	900	1	1
3/4"	3/4"	88	137	120	25	950	1	1
1"	1"	93	157	160	25	1663	1	1
1.1/4"	1.1/4"	131	200	220	25	2808	1	1
1.1/2"	1.1/2"	131	190	220	25	3000	1	1
2"	2"	140	256	250	25	5024	1	1

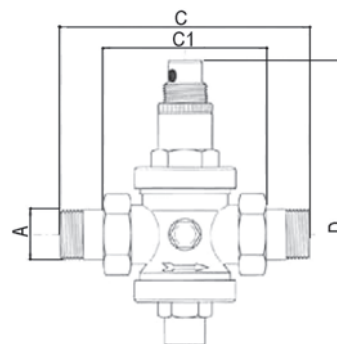



**Art.710** Riduttore di pressione F.F. PN 25

*Water pressure reducer F.F. PN 25*

Riduttore di pressione a pistone in CW617N  
sede e asta in acciaio inox  
Attacchi per manometro su i due lati  
Attacchi filettati F.F.  
Pressione in uscita: 0,5 - 6 bar  
Temp. max.di esercizio: 80°C  
Nichelato

*Pressure reducer in CW617N  
Seat and arm in Stainless Steel  
Manometer attack on 2 sides  
Female attack  
Outgoing pressure: 0,5 - 6 bar  
Maximum temperature: 80°C  
Nickel plated*

Misura	A	C	D	PN	gr.		
3/8"	3/8"	75	120	25	759	1	1
1/2"	1/2"	75	120	25	713	1	1
3/4"	3/4"	85	150	25	1127	1	1
1"	1"	89	160	25	1340	1	1
1.1/4"	1.1/4"	125	220	25	2270	1	1
1.1/2"	1.1/2"	130	220	25	2400	1	1
2"	2"	138	250	25	3563	1	1
2.1/2"	2.1/2"	145	260	25	4000	1	1
3"	3"	177	285	25	5530	1	1
4"	4"	190	310	25	6900	1	1

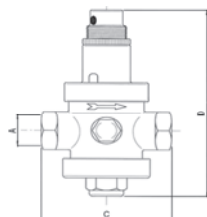

**Disponibile giallo : Art. 710/G**

Available yellow : Art.710/G

**Disponibile giallo con guarniz. Viton : Art. 710/GV**



Available yellow with viton gasket : Art.710/GV

**Art.715** Riduttore di pressione F.F. PN 15

*Water pressure reducer F.F. PN 15*



Riduttore di pressione a pistone in CW617N  
sede e asta in acciaio inox  
Attacchi per manometro  
Attacchi filettati F.F.  
Pressione in uscita: 1 - 4 bar  
Temp. max di esercizio: 80°C  
Nichelato



*Pressure reducer in CW617N  
Seat and arm in Stainless Steel  
Manometer attack on 2 sides  
Female attack  
Outgoing pressure: 1 - 4 bar  
Maximum temperature: 80°C  
Nickel plated*

Misura	A	F	W	C	D	gr.		
3/8"	3/8"	12	26	60	106	457	1	1
1/2"	1/2"	11	26	60	106	421	1	1
3/4"	3/4"	12	31	60	106	423	1	1

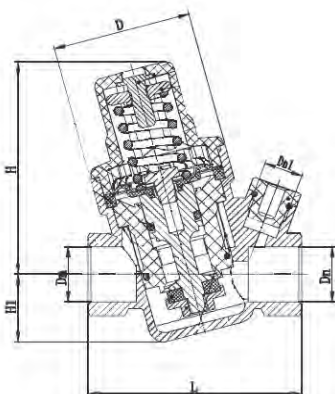
**CON ATTACCO MANOMETRO**

**WITH MANOMETER CONNECTION**

**Art.715/F** Riduttore F.F. **CON FILTRO**
*Water pressure reducer WITH FILTER*

Misura	DN	DN1	L	H	H1	D	gr.		
1/2"	1/2"	1/4"	70,5	72,5	23	46	363	1	1
3/4"	3/4"	1/4"	76,5	72,5	23	46	410	1	1

**CON FILTRO E ATTACCO MANOMETRO**

**WITH FILTER AND MANOMETER CONNECTION**

Fluidi : Acqua  
Range temperatura : 0-80°C  
Range di pressione : 1,5 - 6 bar

*Fluids : water  
Range temperature : 0 ~ 80 °C  
Range pressure : 1,5 - 6 bar*

**Art.716** Ammortizzatore anti-colpo d'ariete

*Shock absorber anti-water hammer*

Valvola anti-colpo d'ariete per impianti idraulici. Assorbe eventuali ritorni violenti di acqua generati dall'impianto a valle. Temperatura massima : 100°C PN 10

*Anti-water hammering for hydraulic system. It absorbs violent reversal of water generated from downstream system*  
Maximum temperature : 100°C  
PN 10

Misura	A	E	C	D	gr.		
1/2"	1/2"	52	45	92	480	1	1

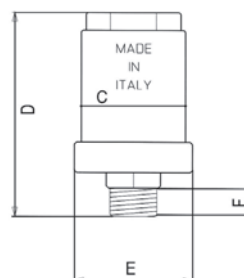

Versione nichelata su richiesta (Art.716/N), minimo 15 pz  
Available also nickel plated (Art.716/N), minimum 15 pcs

**Art.746** Gruppo di alimentazione F.M.

*Filling units F.M.*

Gruppo di alimentazione automatico per impianti di riscaldamento a circuito chiuso, con filtro, valvola di non ritorno e rubinetto di arresto. Attacco F.M. Pressione max in : 10 bar Pressione in uscita : 0,5 - 4 bar Temperatura max. di funzionamento : 80°C Nichelato Manometro

*Automatic filling unit for heating system*  
Built-in filter, non return valve, stopcock and adjustable outlet pressure  
Male fitting outlet  
Maximum pressure inlet : 10 bar  
Outlet pressure range : 0,5-4 bar .Factory setting : 1,5 bar  
Maximum working temperature : 80°C  
Nickel plated  
With manometer

Misura	A		
1/2"	1/2"	1	1

**Art.747** Gruppo di alimentazione con portagomma

*Filling units with hose connector*

Gruppo di alimentazione automatico per impianti di riscaldamento a circuito chiuso, con filtro, valvola di non ritorno, rubinetto di arresto e portagomma. Pressione : PN 10 Pressione in uscita : 0,5 - 4 bar Temperatura max. di funzionamento : 80°C

*Automatic filling unit for heating system*  
Built-in filter, non return valve, stopcock and adjustable outlet pressure  
Male fitting outlet  
Maximum pressure inlet : 10 bar  
Outlet pressure range : 0,5-4 bar  
Maximum working temperature : 80°C  
Nickel plated  
With manometer

Misura	A		
1/2"	1/2"	1	1

**Art.748** Gruppo di alimentazione M.F.

*Filling units M.F.*

Gruppo di alimentazione automatico per impianti di riscaldamento a circuito chiuso, con filtro, valvola di non ritorno e rubinetto di arresto. Attacco M.F. Manometro Pressione : PN 10 Pressione in uscita : 1 - 4 bar Temperatura max. di funzionamento : 80°C

*Automatic filling unit for heating system*  
Built-in filter, non return valve, stopcock and adjustable outlet pressure  
Male fitting outlet  
Maximum pressure inlet : 10 bar  
Outlet pressure range : 1-4 bar  
Maximum working temperature : 80°C

Misura	A		
1/2"	1/2"	1	1

## Art.720



## Riduttore di pressione M.M. PN 25

## Water pressure reducer M.M.



Riduttore di pressione  
con funzionamento  
a membrana, filtro in entrata,  
manometro  $\varnothing$  50 in entrata e in uscita  
Attacchi con raccordo M.M.  
Pressione in uscita: 0,5 - 6 bar  
Temperatura massima: 80°C  
Nichelata

*Pressure reducer in CW617N  
Membrane working, incoming filter  
Manometer  $\varnothing$  50 incoming and outgoing  
Attack with male connector  
Outlet pressure: 0,5 - 6 bar  
Maximum temperature: 80°C  
Nickel plated*

Misura	A	F	C	D	bar in	bar ou	gr.		
1/2"	1/2"	12	165	149	0-25	0-10	1400	1	1
3/4"	3/4"	11	200	160	0-25	0-10	1640	1	1



## Art.2710

## Riduttore F.F. in AISI 316

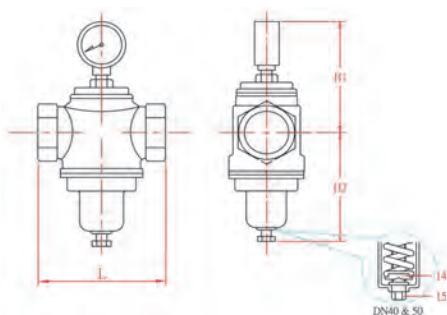
## Pressure reducer F.F. in AISI 316



**INOX AISI 316**

Misura	A	L	H1	H2	gr		
1/2"	1/2"	70	110	80		1	1
3/4"	3/4"	85	115	105		1	1
1"	1"	90	120	105		1	1
1.1/2"	1.1/2"	115	130	130		1	1
2"	2"	120	130	130		1	1
* DN 65	DN65	210	145	195		1	1
* DN 80	DN80	225	145	195		1	1
* DN 100	DN100	250	160	235		1	1
* DN 150	DN150	310	180	300		1	1

\* FLANGIATO  
\* FLANGED

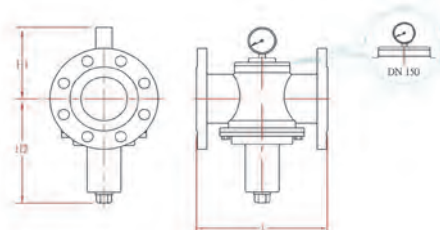

Utilizzo : acqua e aria  
Range temperatura : -15 ~ 80°C  
Range pressione : 1 ~ 6 bar  
4 ~ 10 bar

*Fluids : water and air  
Temperature range : -15 ~ 80 °C  
Pressure range : 1 ~ 6 bar  
4 ~ 10 bar*



## Art.2715

## Riduttore F.F. in AISI 304

## Pressure reducer F.F. in AISI 304



**INOX AISI 304**

Misura	A	L	H	bar (OUT)	gr		
1/2"	1/2"	60	70	1 ÷ 5	400	1	1
3/4"	3/4"	70	70	1 ÷ 5	500	1	1
1"	1"	80	80	1 ÷ 5	800	1	1
1.1/4"	1.1/4"	90	85	1 ÷ 5	1500	1	1
1.1/2"	1.1/2"	110	110	1 ÷ 5	2500	1	1
2"	2"	115	115	1 ÷ 5	3000	1	1
1/2"	1/2"	60	70	4 ÷ 9	400	1	1
3/4"	3/4"	70	70	4 ÷ 9	500	1	1
1"	1"	80	80	4 ÷ 9	800	1	1
1.1/4"	1.1/4"	90	85	4 ÷ 9	1500	1	1
1.1/2"	1.1/2"	110	110	4 ÷ 9	2500	1	1
2"	2"	115	115	4 ÷ 9	3000	1	1

Utilizzo : acqua e aria  
Range temperatura : -15 ~ 80°C  
Range pressione : 1 ~ 5 bar

*Fluids : water and air  
Temperature range : -15 ~ 80 °C  
Pressure range : 1 ~ 5 bar*

## VALVOLE A GALLEGGIANTE E SFERE

*Float valves and balls*



### Caratteristiche tecniche

*Technical features*

---

Corpo : Ottone CW617N UNI EN 12165

Asta : Ottone CW614N UNI EN 12164

Acciaio Inox AISI 304

Guarnizioni di tenuta : EPDM 65 SH

Finitura superficiale sabbata

Filettature : ISO 228

Si raccomanda a tutti gli utilizzatori dei rubinetti a galleggiante di inserire nelle vasche e nei cassoni un'adeguato troppo pieno che deve garantire la fuoriuscita dell'acqua in caso di rottura del rubinetto.

---

*Body : Brass CW617N UNI EN 12165*

*Stem: Brass CW614N UNI EN 12164*

*STAINLESS STEEL AISI 304*

*Gasket : EPDM 65 SH*

*Surface sand blasted*

*Threads : ISO 228*

*We beg all plumbers that use float valves to put into the tank an adequate too full that must guarantee the exit of the liquid in the case must happned a breakage of the tap.*

---

**Art.586** Valvola galleggiante a 5 copiglie

*Float valve*



\* asta tonda con filetto per sfera da 1/4"  
\* 1/2" round stem for ball with thread 1/4"

Misura		
* 1/2"-T		1
1/2"		1
3/4"		1
1"		1
1.1/4"		1
1.1/2"		1
2"		1
2.1/2"		1
3"		1
4"		1

**Art.589** Valvola galleggiante con asta tonda

*Float valve with round arm*



Asta con filetto da 1/4", sede di tenuta in ottone

*Stem with 1/4" thread, brass seat*

Misura	gr.	
1/2"	256	1
3/4"	282	1
1"	380	1

Filetto da 5/16" su richiesta

*Stem with 5/16" thread on request*

**Art.588** Valvola galleggiante PESANTE, asta piatta

*HEAVY Float valve with flat arm*



USO INDUSTRIALE

Sede di tenuta in ottone, asta piatta INOX

\* Per il 1/2" si deve assemblare la sfera ø120

INDUSTRIAL USE

Brass seat, flat Stainless Steel arm

\* For 1/2" size you must use the ball ø120

Misura	gr.	
1/2"	410	1
3/4"	438	1
1"	566	1
1.1/4"	1405	1
1.1/2"	1860	1
2"	2420	1

**Art.585** Tubo silenziatore in PVC per Art.588

*PVC silencer pipe for Art.588*

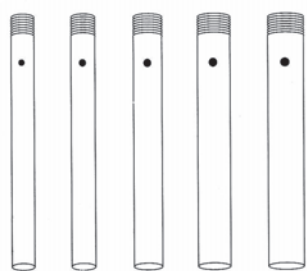

Art.585/B : tubo silenziatore per Art.589

Art.585/B : PVC silencer pipe for Art.589

Misura		
1/2"	---> Art.588 - 1/2" & Art.588 - 3/4"	1
3/4"	---> Art.588 - 1"	1
1"	---> Art.588 - 1.1/4"	1
1.1/4"	---> Art.588 - 1.1/2"	1
1.1/2"	---> Art.588 - 2"	1

**Art.585/B**

Misura		
M14x1	---> Art.589 - 1/2" & Art.589 - 3/4"	1
M18x1	---> Art.589 - 1"	1

**Art.587**

Sfera in plastica per Art.586 e Art.588

*Plastic ball for Art.586 and Art.588*

CON FILETTO / WITH THREAD



Misura	A	FILETTO/THREAD	
* ø 90-P	1/2"	1/4"W	1
ø 90	1/2"	5/16"W	1
ø 120	1/2" e 3/4"	5/16"W	1
ø 150	1"	5/16"W	1
ø 180	1.1/4"	5/16"W	1
ø 220	1.1/2" e 2"	5/16"W	1
ø 300	2.1/2" - 3" - 4"	5/16"W	1

 Tutte le misure con reggisfera scorrevole e nottolino fil.  
*All sizes with sliding ball-holder and threaded pawl*

 \* sfera piatta (solo per sfera ø 90-P)  
*flat ball (only for ball ø 90-P)*
**Art.587/F**

Sfera in plastica con nottolino ed asola

*Plastic ball with threaded pawl and ring*

Misura	A	
ø 150	1"	1

**Art.587/FG**

Gancio inox per sfera

*SS hook for ball*



Misura	A	
		1

**Art.589/B**

Sfera in plastica tonda per Art.589

*Plastic ball for Art.589*

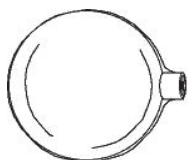
FILETTO / THREAD



Misura	A	FILETTO/THREAD	
ø 90	1/2"	1/4" W	1
ø 120	3/4"	1/4" W	1
ø 150	1"	1/4" W	1

 Filetto 5/16" su richiesta  
*Thread 5/16" on request*



**Art.587/R** Sfera in rame tonda per Art.586 e Art.588 *Round Copper ball for Art.586 and Art.588*



Misura	A	FILETTO/THREAD	
* ø 90	1/2"	1/4" W	1
* ø 100	1/2" & 3/4"	1/4" W	1
ø 120	1/2" e 3/4" per asta piatta		1
ø 150	1"		1
ø 180	1.1/4"		1
ø 220	1.1/2" e 2"		1
ø 300	2.1/2" - 3" - 4"		1

\* solo con attacco filettato 1/4" ( sfere ø 90 e ø 100)  
*only with 1/4" thread (balls ø 90 and ø 100)*

Le altre misure hanno reggisfera scorrevole  
*The other sizes have sliding ball-holder*

**Art.584** Reggisfera scorrevole per asta piatta *Sliding ball-holder for flat arm*



Misura	
4 x 18 mm	1
6 x 20 mm	1

**Art.2588** Valvola a galleggiante AISI 316 *Float valve S.S. AISI 316*



INOX AISI 316

Misura	
1/2"	1
3/4"	1
1"	1
1.1/4"	1
1.1/2"	1
2"	1
2.1/2"	1

Disponibile anche in INOX 304 : Art.2588/L (prezzi su richiesta)

*Available also in SS AISI 304 : Art.2588/L (prices on request)*

**Art.2587** Sfera AISI 316 per galleggiante Art.2588 *Ball AISI 316 for Art.2588*



INOX AISI 316

Misura	Artt.2588 - 2588/L	
110	1/2"	1
160	3/4" - 1" - 1.1/4"	1
200	1.1/2" - 2" - 2.1/2"	1

Disponibile anche in INOX 304 : Art.2587/L (prezzi su richiesta)

*Available also in SS AISI 304 : Art.2587/L (prices on request)*

**Art.750** Portamanometro con flangia PN 16

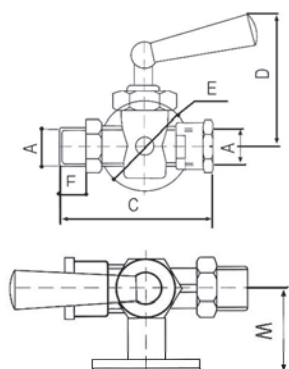
*Manometer holder with flange PN 16*

Misura	A	F	W	E	C	D	gr.	
1/4"	1/4"	10	31,5	40	60	60	217	10
3/8"	3/8"	12	31,5	40	68	60	245	10
1/2"	1/2"	14	31,5	40	74	60	287	10

**Art.755** Portamanometro M.F. PN 16

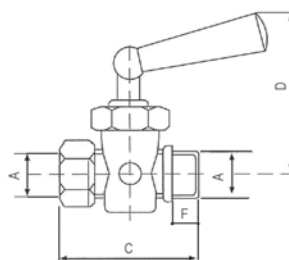
*Manometer holder M.F. PN 16*

Misura	A	F	C	D	gr.	
1/4"	1/4"	8	46	60	131	10
3/8"	3/8"	10	50	60	142	10
1/2"	1/2"	12	56	60	173	10

**Art.760** Portamanometro F.F. PN 16

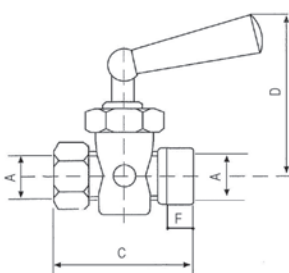
*Manometer holder F.F. PN 16*

Misura	A	F	C	D	gr.	
1/4"	1/4"	8	46	60	134	10
3/8"	3/8"	10	50	60	145	10
1/2"	1/2"	12	56	60	176	10

**Art.765** Ricciolo per manometro PN 16

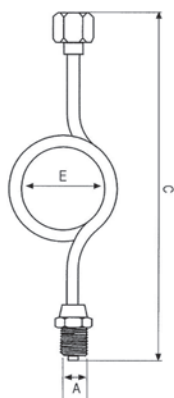
*Manometer curls PN 16*

Misura	A	C	E	gr.	
1/4"	1/4"	157	162	86	10
3/8"	3/8"	158	162	106	10
1/2"	1/2"	160	162	141	10

Tubo in rame ø8 x 1 nichelato

*Copper pipe ø8 x 1 nickel plated*

Manometri a secco attacco posteriore

Dry manometers back attack



Con bordo e staffa per montaggio a pannello  
With rim and U-clamp for panel mounting



\* (AS) = SENZA INDICATORE ROSSO  
WITHOUT RED POINTER



Altre scale e modelli  
 disponibili su richiesta  

---

 Other scales and models  
 available on request

ARTICOLO	DN	CASSA	ATT.	CODICE	Bar + Psi	
Art.836	40	ABS	R 1/8"	836/10	0-1	1
				836/09	0-2,5	1
				836/01	0-4	1
				836/04	0-6	1
				836/07	0-10	1
				836/02	0-12	1
			R 1/4"	836/05	0-6	1
				836/06	0-10	1
Art.836/B	INOX (SS)		G 1/8"	836/B/01	0-12	1
			R 1/8"	838/01	0-12	1
Art.838			R 1/4"	838/02	0-12	1
Art.837	50	ABS	R 1/8"	837/07	0-10	1
				837/01	0-12	1
			R 1/4"	837/03	0-2,5	1
				837/04	0-6	1
				837/06	0-10	1
				837/02	0-12	1
				837/05	0-16	1
Art.839	INOX (SS)		R 1/8"	839/01	0-12	1
			G 1/4"	839/02	0-12	1
Art.850/A	63	ABS	G 1/4"	850/A/09	-1-0	1
				850/A/07	0-4	1
				850/A/01	0-6	1
				850/A/02	0-10	1
				850/A/03	0-16	1
				850/A/08	0-20	1
				850/A/04	0-25	1
				850/A/05	0-40	1
Art.850/AS	ABS	G 1/4"	850/AS/02	-1-0	1	
			850/AS/03	0-2,5	1	
			850/AS/04	0-4	1	
			850/AS/01	0-12	1	
Art.850	INOX (SS)	G 1/4"	850/05	0-0,6	1	
			850/01	0-6	1	
			850/02	0-10	1	
			850/03	0-16	1	
			850/04	0-25	1	
Art.848	80	ABS	G 3/8"	848/01	0-1	1
				848/02	0-1,6	1
				848/03	0-2,5	1
				848/04	0-4	1
				848/05	0-6	1
				848/06	0-10	1
				848/07	0-16	1
				848/08	0-25	1
				848/09	0-40	1



ATTACCO a 180°  
Connection at 180°

ARTICOLO	DN	CASSA	ATT.	CODICE	Bar + Psi	
Art.836/R	40	ABS	R 1/8"	836/R/05	-1-0	1
				836/R/03	0-4	1
				836/R/04	0-6	1
				836/R/06	0-12	1
				836/R/07	0-10	1
			R 1/4"	836/R/02	0-6	1
				836/R/01	0-10	1
G 1/4"	836/R/O/01	0-6	1			

840/V : cassa acciaio verniciato su richiesta

steel painted case on request



Art.840/A	50	ABS	R 1/8"	840/A/07	0-6	1
				840/A/08	0-10	1
				840/A/09	0-12	1
				840/A/10	0-16	1
			R 1/4"	840/A/05	0-2,5	1
				840/A/06	0-6	1
				840/A/01	0-10	1
				840/A/02	0-12	1
				840/A/03	0-16	1
				840/A/04	0-25	1
Art.840		INOX (SS)	G 1/4"	840/01	0-10	1
				840/02	0-16	1
				840/03	0-25	1
Art.842		INOX (SS)	R 1/8"	842/02	0-6	1
			G 1/4"	842/01	0-1	1

CASSA INOX, TENUTA STAGNA  
Riempibile di glicerina  
Proof SS case

845/V : cassa acciaio verniciato su richiesta

steel painted case on request

Altre scale e modelli disponibili su richiesta  
Other scales and models available on request

(AS) = SENZA INDICATORE ROSSO  
(AS) = WITHOUT RED POINTER



Art.845/A	63	ABS	G 1/4"	845/A/12	-1-0	1				
				845/A/09	0-1	1				
				845/A/08	0-2,5	1				
				845/A/07	0-4	1				
				845/A/01	0-6	1				
				845/A/02	0-10	1				
				845/A/10	0-12	1				
				845/A/03	0-16	1				
				845/A/11	0-20	1				
				845/A/04	0-25	1				
				845/A/05	0-40	1				
				845/A/06	0-60	1				
				Art.845/AS		ABS	G 1/4"	845/AS/04	-1-0	1
								845/AS/03	0-2,5	1
845/AS/01	0-4	1								
845/AS/05	0-6	1								
845/AS/06	0-10	1								
845/AS/02	0-12	1								
845/AS/07	0-16	1								
Art.845		INOX (SS)	G 1/4"	845/04	-1+3	1				
				845/01	0-6	1				
				845/02	0-10	1				
				845/03	0-16	1				
				845/05	0-25	1				

Manometri a secco attacco radiale

Dry manometer radial attack



ARTICOLO	DN	CASSA	ATT.	CODICE	Bar + Psi	
Art.847	80	ABS	G 3/8"	847/01	0-1	1
				847/02	0-1,6	1
				847/03	0-2,5	1
				847/04	0-4	1
				847/05	0-6	1
				847/06	0-10	1
				847/07	0-16	1
				847/08	0-25	1
				847/09	0-40	1

Manometri con OLIO DI SILICONE att.posteriore

Manometer with SILICON OIL back attack



ARTICOLO	DN	CASSA	ATT.	CODICE	Bar + Psi	
Art.865	40	INOX (SS)	R 1/8"	865/01	0-16	1
				865/02	0-160	1

Art.841	50	INOX (SS)	G 1/4"	841/01	0-6	1
---------	----	-----------	--------	--------	-----	---

Art.851	63	INOX (SS)	G 1/4"	851/13	-1-0	1
				851/08	0-1	1
				851/16	0-2,5	1
				851/14	0-4	1
				851/01	0-6	1
				851/02	0-10	1
				851/15	0-12	1
				851/03	0-16	1
				851/19	0-20	1
				851/04	0-25	1
				851/05	0-40	1
				851/06	0-60	1
				851/07	0-100	1
				851/09	0-160	1
				851/10	0-250	1
				851/11	0-315	1
				851/12	0-400	1
				851/17	0-600	1
851/18	0-1000	1				

Art.860		TUTTO INOX ALL SS	G 1/4"	860/05	-1-0	1
				860/06	0-4	1
				860/01	0-6	1
				860/02	0-10	1
				860/03	0-16	1
				860/04	0-25	1

Art.861	100	INOX (SS)	G 1/2"	861/09	0-1	1
				861/10	0-1,6	1
				861/08	0-2,5	1
				861/07	0-4	1
				861/01	0-6	1
				861/02	0-10	1
				861/03	0-16	1
				861/04	0-25	1
				861/05	0-60	1
				861/06	0-100	1
				861/11	0-160	1
				861/12	0-250	1
				861/13	0-315	1
				861/14	0-400	1
				861/15	0-600	1

Altre scale e modelli  
disponibili su richiesta

Other scales and models  
available on request

Manometro con OLIO DI SILICONE attacco radiale *Manometers with SILICON OIL radial attack*



ARTICOLO	DN	CASSA	ATT.	CODICE	Bar + Psi	
Art.844	50	INOX (SS)	G 1/8"	844/01	0-6	1
Art.846	63	INOX (SS)	G 1/4"	846/05	-1-0	1
				846/07	-1+1,5	1
				846/06	-1+3	1
				846/19	0-0,6	1
				846/10	0-1	1
				846/08	0-2,5	1
				846/09	0-4	1
				846/01	0-6	1
				846/02	0-10	1
				846/20	0-12	1
				846/03	0-16	1
				846/22	0-20	1
				846/04	0-25	1
				846/11	0-40	1
				846/12	0-60	1
				846/13	0-100	1
				846/17	0-160	1
				846/14	0-250	1
				846/15	0-315	1
				846/16	0-400	1
				846/18	0-600	1
846/21	0-1000	1				
Art.855		TUTTO INOX ALL SS	G 1/4"	855/08	0-4	1
				855/01	0-6	1
				855/02	0-10	1
				855/03	0-16	1
				855/04	0-25	1
				855/07	0-40	1
				855/05	0-60	1
855/06	0-100	1				
Art.856	100	INOX (SS)	G 1/2"	856/10	-1-0	1
				856/23	-1-1,5	1
				856/24	-1-3	1
				856/08	0-1	1
				856/22	0-1,6	1
				856/09	0-2,5	1
				856/07	0-4	1
				856/01	0-6	1
				856/02	0-10	1
				856/25	0-12	1
				856/03	0-16	1
				856/26	0-20	1
				856/04	0-25	1
				856/27	0-40	1
				856/05	0-60	1
				856/06	0-100	1
				856/19	0-160	1
				856/20	0-250	1
				856/28	0-315	1
				856/17	0-400	1
				856/18	0-600	1
856/21	0-1000	1				

Altre scale e modelli disponibili su richiesta  
 Other scales and models available on request

Manometro a membrana per gas / bassa pressione *Capsule pressure gauge for gas / low pressure*

Cassa acciaio cromato

*Case in Chromed steel*

 Attacco : radiale in ottone  
 Elemento manometrico :  
 Membrana in lega di rame  
 precisione Cl.2,5

*Back connection in brass  
 Sensing element :  
 copper alloy capsule  
 accuracy Cl. 2,5*

ARTICOLO	DN	CODICE	mbar / mmH <sub>2</sub> O	ATT.	
Art.845/PM	63	845/PM/03	0-60 mbar/mmH <sub>2</sub> O	G1/4"	1
		845/PM/04	0-100 mbar/mmH <sub>2</sub> O		1
		845/PM/05	0-150 mbar/mmH <sub>2</sub> O		1
		845/PM/06	0-250 mbar/mmH <sub>2</sub> O		1
		845/PM/07	0-400 mbar/mmH <sub>2</sub> O		1
		845/PM/08	0-600 mbar/mmH <sub>2</sub> O		1
Art.847/PM	80	847/PM/01	0-60 mbar/mmH <sub>2</sub> O	G3/8"	1
		847/PM/02	0-100 mbar/mmH <sub>2</sub> O		1
		847/PM/03	0-150 mbar/mmH <sub>2</sub> O		1
		847/PM/04	0-250 mbar/mmH <sub>2</sub> O		1
		847/PM/05	0-400 mbar/mmH <sub>2</sub> O		1
		847/PM/06	0-600 mbar/mmH <sub>2</sub> O		1
Art.857/PM	100	857/PM/01	0-60 mbar/mmH <sub>2</sub> O	G1/2"	1
		857/PM/02	0-100 mbar/mmH <sub>2</sub> O		1
		857/PM/03	0-150 mbar/mmH <sub>2</sub> O		1
		857/PM/04	0-250 mbar/mmH <sub>2</sub> O		1
		857/PM/05	0-400 mbar/mmH <sub>2</sub> O		1
		857/PM/06	0-600 mbar/mmH <sub>2</sub> O		1

**Art.890**

Termo-manometro ø80, cassa INOX

*Thermo-manometer ø80, stainless steel case*

**Cassa acciaio**

Attacco radiale in ottone 1/4"

Valvola di ritegno attacco 1/2"

Scala (bar)	psi	Temp.	A	
0-2,5	36	0-120°C	1/2"	1
0-4	58	0-120°C	1/2"	1
0-6	87	0-120°C	1/2"	1

*Steel case*
*Brass radial connection 1/4"*
*Check valve with connection 1/2"*
**Art.891**

Termo-manometro ø80, cassa INOX

*Thermo-manometer ø80, stainless steel case*

**Cassa acciaio**

Att. posteriore in ottone 1/4"

Valvola di ritegno attacco 1/2"

Scala (bar)	psi	Temp.	A	
0-2,5	36	0-120°C	1/2"	1
0-4	58	0-120°C	1/2"	1
0-6	87	0-120°C	1/2"	1

*Steel case*
*Brass back connection 1/4"*
*Check valve with connection 1/2"*
**Art.896**

Termometro ø 40 con clips

*Thermometer ø40 with clips*

Misura L	Temperatura	C	D	
34 mm	0-120°C	50	63	10

**Cassa Inox**
*Stainless Steel case*

**Art.895**

Termometro con pozzetto in ottone

*Thermometer with brass pocket*

**Cassa e gambo Inox**

 Pozzetto in ottone  
Filetto 1/2"

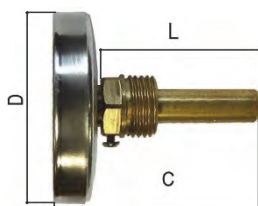
*Stainless Steel case  
Stainless Steel stem  
Brass pocket  
Thread 1/2"*

DN	CODICE	Temperatura	L=mm	
63	895/01	0-120°C	34	1
	895/02	0-120°C	50	1

80	895/03	-30-50°C	50	1
	895/04	-30-50°C	75	1
	895/05	-30-50°C	100	1
	895/06	-30-50°C	150	1
	895/07	-30-50°C	200	1
	895/08	0-60°C	50	1
	895/09	0-60°C	75	1
	895/10	0-60°C	100	1
	895/11	0-60°C	150	1
	895/12	0-60°C	200	1
	895/13	0-120°C	50	1
	895/14	0-120°C	75	1
	895/15	0-120°C	100	1
	895/16	0-120°C	150	1
895/17	0-120°C	200	1	

100	895/18	-30-50°C	50	1
	895/19	-30-50°C	75	1
	895/20	-30-50°C	100	1
	895/21	-30-50°C	150	1
	895/22	-30-50°C	200	1
	895/23	0-60°C	50	1
	895/24	0-60°C	75	1
	895/25	0-60°C	100	1
	895/26	0-60°C	150	1
	895/27	0-60°C	200	1
	895/28	0-120°C	50	1
	895/29	0-120°C	75	1
	895/30	0-120°C	100	1
	895/31	0-120°C	150	1
	895/32	0-120°C	200	1

Altre scale e modelli  
disponibili su richiesta

*Other scales and models  
available on request*

**Art.897**

Termometro con pozzetto in ottone

*Thermometer with brass pocket*

**Cassa Inox**

 Gambo radiale INOX  
Pozzetto in ottone  
Filetto 1/2"

*Stainless Steel case  
Stainless Steel stem  
Brass pocket  
Thread 1/2"*

DN	CODICE	Temperatura	L=mm	
80	897/06	-35-50	75	1
	897/07	-35-50	100	1
	897/04	0-60°C	75	1
	897/01	0-60°C	100	1
	897/05	0-120°C	50	1
	897/02	0-120°C	100	1
	897/03	0-200°C	100	1

**Manometro isometrico**
*Thermometer with brass pocket*

- CASSA : INOX (SS)
- ATTACCO : G 1/4"

ARTICOLO	DN	COD.	Bar + Psi	
889	63	889/01	20/40/60	1
		889/02	5/20/25	1
		889/03	8/20/25	1
		889/04	15/25/60	1
889/DN100	100	889/DN100/01	5/20/25	1
		889/DN100/02	15/20/60	1



**Art.895/P** Pozzetto per Art.895

*Brass pocket for Art.895*



Altre misure su richiesta

Misura L	A		
34 mm	1/2"		1
50 mm	1/2"		1
75 mm	1/2"		1
100 mm	1/2"		1
150 mm	1/2"	IN RAME / COPPER	1
200 mm	1/2"	IN RAME / COPPER	1
300 mm	1/2"	IN RAME / COPPER	1

**Art.867** Cuffia di protezione per manometri

*Rubber cover*



Misura		
R 63	per manometro con attacco radiale DN63	1
P 63	per manometro con attacco posteriore DN100	1
R 100	per manometro con attacco posteriore DN64	

Disponibili in tre colori : *Available in 3 colors*  
 • 867 : nero *• 867 : black*  
 • 867/B : blu *• 867/B : blue*  
 • 867/R : rosso *• 867/R : red*

**Art.866** Flangia per manometri

*Flange for pressure gauges*



Flangia per articoli :  
 Art.846 - Art.851 - Art.855 -  
 Art.860 - Art.865

*Flange for articles :*  
 Art.846 - Art.851 - Art.855 -  
 Art.860 - Art.865

Misura		
ø 40 P	per manometro ø 40 con attacco posteriore	1
ø 63 P	per manometro ø 63 con attacco posteriore	1
ø 63 R	per manometro ø 63 con attacco radiale	1
ø 100 P	per manometro ø 100 con attacco posteriore	1

**Art.868** Staffa

*U-CLAMP*

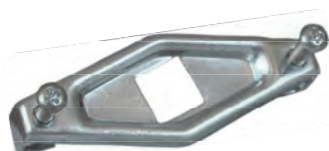

Misura	
ø 40	1
ø 50	1
ø 63	1
ø 100	1

**Art.869** Ammortizzatore anti colpo di ariete

*Shock absorber*



Misura	scala	
1/4"	0-20 bar	1
1/4"	20-300 bar	1
3/8"	0-20 bar	1
3/8"	20-300 bar	1
1/2"	0-20 bar	1
1/2"	20-300 bar	1

**Art.875** Pistola per aria compressa

*Air gun*

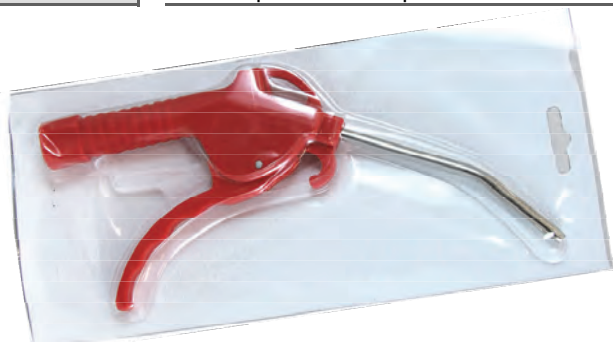

Misura	
1/4"	1

In Blister

**Art.870** Manometro prova vasi

*Tire pressure gauge*

Cassa Inox  
 Attacco con tubo in gomma  
 con valvola.  
 Per pneumatici e  
 vasi di espansione

*Stainless Steel case  
 Connection with rubber pipe  
 and valve.  
 For tire and expansion tank*

**Art.871** Manometro provavasi + valvola di scarico

*Manometer expansion tank with discharge valve*

Cassa Inox  
 Attacco con tubo in gomma  
 con valvola e valvola di  
 scarico  
 Per pneumatici e  
 vasi di espansione

*Stainless Steel case  
 Connection with rubber pipe  
 valve and exhaust valve  
 For tire and expansion tank*

**Art.872** Pistola con manometro, tubo e attacco

*Tire gun with gauge, pipe and connector*

Manometro, tubo e valvola  
 Per pneumatici e  
 vasi di espansione

*Manometer, pipe and valve  
 For tire and expansion tank*



**Art.876** Pistola aria in alluminio con attacco rapido

*Aluminium air gun with quick joint*

In Blister

**Art.249/B** Rubinetto sottolavabo a sfera c/filtro

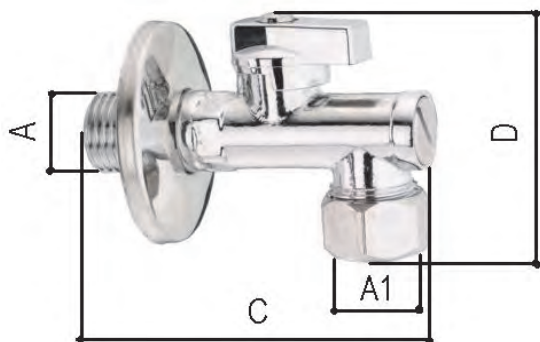
*Under washbasin bibcock w/filter*



Misura	A	A1	C	D	gr.		
1/2"x10	1/2"	10	72	51	148	10	100

Completo di filtro, dado, ogiva e rosone

*With ball, filter, nut and washer*

**Art.250/B** Rubinetto sottolavabo a sfera c/filtro

*Under washbasin bibcock w/filter*

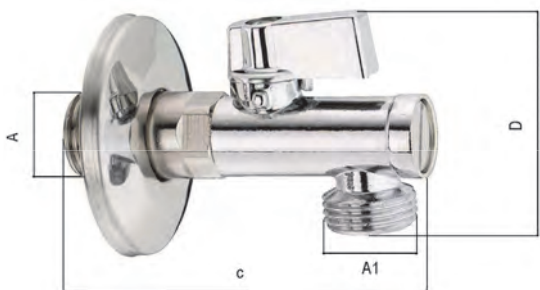

Misura	A	A1	C	D	gr.		
1/2" x 3/8"	1/2"	3/8"	72	48	128	15	150
1/2" x 1/2"	1/2"	1/2"	72	48	130	15	150

Completo di filtro e rosone, SEDE PIANA

*With filter and washer, FLAT SEAT*

**Art.250** Rubinetto sottolavabo a sfera c/filtro

*Under washbasin bibcock w/filter*



Misura	A	A1	C	D	gr.		
1/2" x 1/2"	1/2"	1/2"	82	48	130	10	100

Completo di filtro e rosone, SEDE PIANA

*With filter and washer, FLAT SEAT*

**Lunghezza 82 mm**

**Lenght 82 mm**

**Art.251/B** Rubinetto sottolavabo a sfera

*Under washbasin bibcock*



Misura	A	ø	C	D	gr.		
1/2" x 10	1/2"	10	72	80	184	10	100

Completo di filtro, snodo e rosone

*With filter, joint and washer*

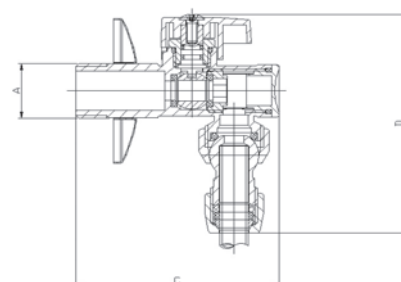

**Art.251** Rubinetto sottolavabo a sfera

*Under washbasin bibcock w/filter*

Misura	A	ø	C	D	gr.		
1/2" x 10	1/2"	10	82	84	221	10	100

**MODELLO PESANTE**  
Completo di filtro, snodo e rosone  
**MANIGLIA METALLICA CROMATA**

**HEAVY MODEL**  
With filter, joint and washer  
**CHROME METAL HANDLE**

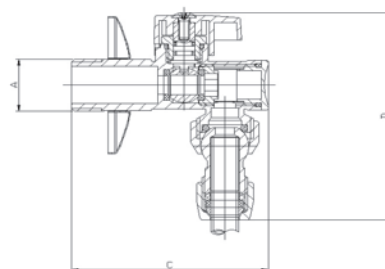
**Art.576/R** Rubinetto sottolavabo lungo

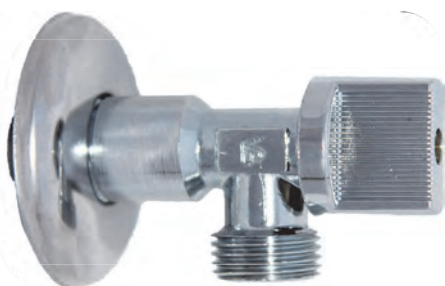
*Under washbasin long type*

Misura	A	A1	C	gr.		
1/2" x 1/2"	1/2"	1/2"	79,5	107	2	150

A chiusura rapida 90°

*Rapid closing 90°*

**Art.575** Rubinetto ad angolo

*Angle tap*

Misura	A	A1	C	D	gr.		
1/2" x 1/2"	1/2"	1/2"	36	77	160	1	150

Con maniglia tricorno in zama

*With zinc alloy tricorno handle*

**Art.671** Rubinetto sottolavabo Quadrato

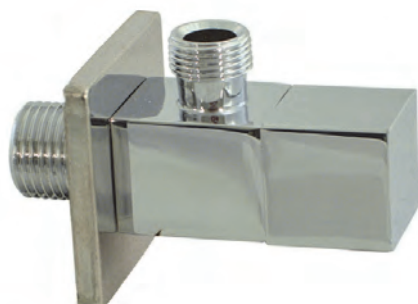
*Square underwashbasin*

Misura	A	A1	gr.		
1/2" x 3/8"	1/2"	3/8"	238	20	20

Con cartuccia ceramica

*With ceramic cartridge*

**Art.672** Rubinetto sottolavabo Triangolare

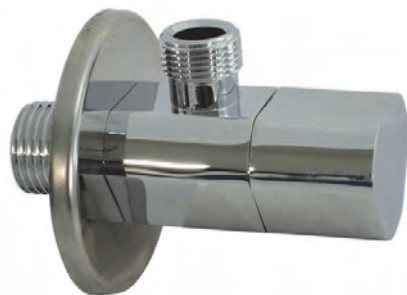
*Triangular underwashbasin*

Misura	A	A1	gr.		
1/2" x 3/8"	1/2"	3/8"	242	10	10

Con cartuccia ceramica

*With ceramic cartridge*
**Art.673** Rubinetto sottolavabo Tondo

*Round underwashbasin*

Misura	A	A1	gr.		
1/2" x 3/8"	1/2"	3/8"	225	10	10

**Art.673/L** Modello leggero  
*Light model*

Misura	A	A1	gr.		
1/2" x 3/8"	1/2"	3/8"	180	10	10
1/2" x 1/2"	1/2"	1/2"	185	10	10

Con cartuccia ceramica

*With ceramic cartridge*
**Art.666** Distanziatore per gruppi con att.lavatrice *Washing machine bibcock with connection*

Misura	A	C	gr.		
3/4" x 4 cm	3/4"	4 cm	252	1	20

**Art.667** Rubinetto tre vie per lavatrice

*3 ways bibcock for washing machine*

Misura	gr.		
1/2" x 3/4"	160	1	20

**Art.663** Rubinetto att.lavatrice

*Double bibcock with washing machine connection*

Misura	A	A1	gr.		
1/2" x 3/4"	1/2"	3/4"	286	1	10

**Art.664** Rubinetto doppio attacco lavatrice

*Double underwasbasin bibcock with washing machine connect.*

Misura	A	A1	A2	gr.		
1/2"x3/4"x3/4"	1/2"	3/4"	3/4"	277	1	5

**Art.254/S** Rubinetto doppio attacco lavatrice

*Double underwasbasin bibcock with washing machine connect.*

Misura	A	A1	ø	gr.		
1/2"x3/4"x10	1/2"	3/4"	10	262	1	5

**Art.254/S/PG** CON PORTAGOMMA

Misura	A	A1	ø	gr.		
1/2"x3/4"x10	1/2"	3/4"	10	281	1	5

**Art.255/P** Rubinetto lavatrice Lux

*Angle ball valve for washing machine, Lux type*

Misura	A	A1	C	D	gr.		
1/2" x 3/4"	1/2"	3/4"	75	60	195	15	150

**Art.255/PA** CON MANIGLIA IN PLASTICA

Misura	A	A1	C	D	gr.		
1/2" x 3/4"	1/2"	3/4"	75	60	160	15	150

**Art.255** Rubinetto a squadra per lavatrice

*Angle ball valve for washing machine*

Misura	A	A1	C	D	gr.		
1/2" x 3/4"	3/4"	1/2"	59	66	133	15	150

**Art.255/G** Rubinetto a sfera a squadra

*Right angle ball valve*

Misura	A	A1	C	D	gr.		
1/2" x 1/2"	1/2"	1/2"	54	66	130	15	150

**Art.618/S** Curvetta 90° in ottone stampato

*Chrome plated elbow 90°*

Misura	A	ø	gr.		
3/8" x 10	1/2"	10	130	20	20
1/2" x 10	1/2"	10	130	16	112

Completo di prolunga e ogiva

*With extension and ogive*
**Art.619/S** Curvetta 90° in rame cromato

*Chrome plated copper Elbow 90°*

Misura	A	ø	gr.		
1/2" x 10	1/2"	10	94	2	20

Completo di prolunga e ogiva

*With extension and ogive*
**Art.617** Prolunga ridotta cromata

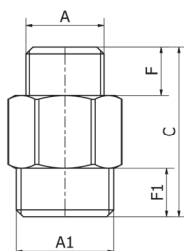
*Chromium plated reduced extension*

Misura	A	A1	F	F1	C	gr.		
3/8" x 1/2"	3/8"	1/2"	10	12	37	49	10	480

**Art.617/S** Prolunga ridotta cromata con dado

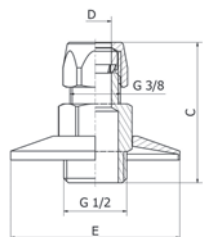
*Chromium plated reduced extension with nut*

Misura	A	D	E	C	gr.		
1/2" x 10	1/2"	10	42	38	73	20	400

Con dado e rosone

*With nut and rosette*
**Art.618** Prolunga cromata

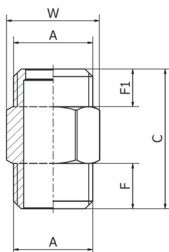
*Chromium plated extension*

Misura	A	A1	F	F1	C	W	gr.		
1/2" x 1/2"	1/2"	1/2"	10	12	37	21	48	10	400

**Art.624** Curvetta 90° M.M.

*Elbow 90° M.M.*

Misura	A	gr.		
1/2"x1/2"	1/2"	82	20	200

Completo di rosone

*With rosette*
**Art.252** Rosetta

*Rosette*

			20	20

**Art.252/E** Rosetta con foro esagonale

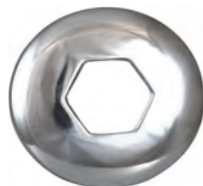
*Rosette with hexagonal hole*

			10	10

**Art.252/T** Tappo con rosette e vite

*Rosette with hexagonal hole*

Misura		
1/2"	10	10



**Art.7000** Rubinetto per lavello a parete canna U *Wall sink tap with U spout*



Su richiesta / on request



Art.7001 con 2 manopole

Art.7001 with 2 handles



Art.7000/T con maniglia a triangolo

Art.7000/T with zinc alloy tricorn handle



Art.7001/T con 2 maniglie a triangolo

Art.7001/T with 2 zinc alloy tricorn handles

**Art.7005** Monoforo mono lavello canna alta *Single tap with high swivel spout*



Su richiesta / on request



Art.7006 con 2 manopole

Art.7006 with 2 handles



Art.7006/T con 2 maniglie a triangolo

Art.7006/T with 2 zinc alloy tricorn handles

**Art.7010** Miscelatore canna alta per lavello *Sink mixer high swivel spout*



**Art.7015** Miscelatore a parete per lavello *Wall sink mixer*



**Art.7020** Miscelatore per lavello

*Sink mixer*



**Art.7021** Miscelatore per lavello con doccia

*Sink mixer with hand shower*



Art.7021/D doccetta di ricambio

Art.7021/D hand shower for Art.7021

Art.7021/F Flessibile di ricambio

Art.7021/F Flexible for Art.7021

Con doccia estraibile  
*With extractable hand shower*

**Art.7022** Miscelatore flessibile per lavello

*Flexible sink mixer*



**Art.7025** Miscelatore per lavabo con piletta 1.1/4" *Washbasin mixer with waste 1.1/4"*

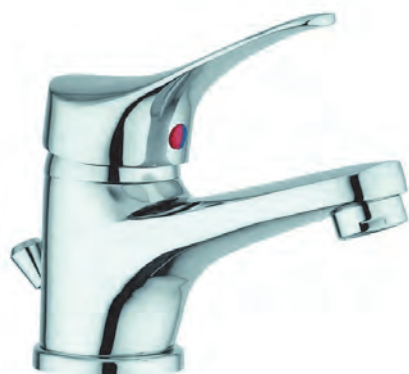

**Art.7030** Miscelatore per bidet con piletta 1.1/4" *Bidet mixer with waste 1.1/4"*



	
1	10

**Art.7035** Miscelatore vasca *External bath mixer*



	
1	10

Con flessibile e doccia  
*With flexible and hand shower*



**Art.7040** Miscelatore incasso doccia *Built-in shower mixer*



	
1	10

**Art.7045** Saliscendi completo *Sliding rail*



				
Standard	Attacchi fissi	8 funzioni	1	10
Luxury	Attacchi mobili	3 funzioni	1	10

Con portasapone  
*With soap holder*

**Art.248** Rubinetto a squadra

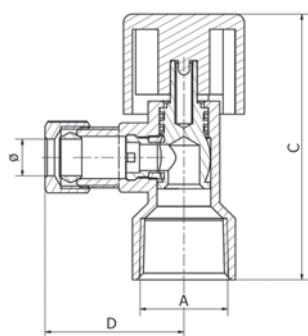
*Valvula escuadra*

Misura	A	C	D	Ø	gr.		
1/2" x 10	1/2"	61	31	10	82	15	240

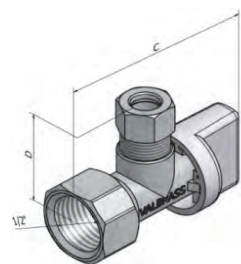

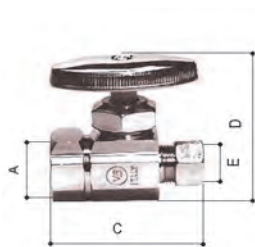
**Art.578** Rubinetto diritto

*Valvula de control al piso*

Misura	A	E	C	D	gr.		
1/2"	1/2"	10	53	53	149	40	160

Confezionati in blister

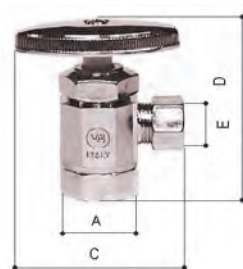
*Blister packing*
**Art.579** Rubinetto a squadra

*Valvula de control a la pared*

Misura	A	E	C	D	gr.		
1/2"	1/2"	10	40	56	120	40	160

Confezionati in blister

*Blister packing*
**Art.580** Rubinetto doppio

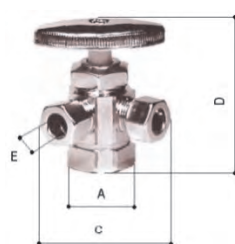
*Valvula de control doble*

Misura	A	E	C	D	gr.		
1/2"	1/2"	10	40	56	129	40	120

Confezionati in blister

*Blister packing*

# FLESSIBILE ESTENSIBILI PER ACQUA E GAS

*Flexible Extensible for water and gas*



## FLESSIBILE ESTENSIBILE INOX PER ACQUA

### INOX EXTENSIBLE FLEXIBLE WATER CONNECTION

**Art.6500**

Flessibile estensibile M.F. **senza** rivestimento

*Extensible flexible connection M.F. **without** coating*



UNI CIG 7129

- Pressione in ingresso max : 10 bar
  - Temperatura max : 200 °C
  - Soffietto : AISI 304
  - Dado : ottone nichelato
  - Raccordo : AISI 304
  - Guarnizione : EPDM
- *Pressure in : 10 bar*
  - *Max temperature : 200 °C*
  - *Hose : AISI 304*
  - *Nut : Nickel plated brass*
  - *Fitting : AISI 304*
  - *Gasket : EPDM*

Utilizzo :

Applicazione sanitaria, serbatoi  
boiler, caldaia

Use :

*Sanitary applications, tank  
boiler and heater*



Misura	M.F.	L min / L max	s	
1/2"x1/2"		75 / 130	0,2	10
1/2"x1/2"		100 / 200	0,2	10
1/2"x1/2"		200 / 400	0,2	10
1/2"x1/2"		260 / 520	0,2	10
1/2"x1/2"		500 / 1000	0,2	10
1/2"x1/2"		750 / 1500	0,2	10
1/2"x1/2"		1000 / 2000	0,2	10
1/2"x3/4"		75 / 130	0,2	10
1/2"x3/4"		100 / 200	0,2	10
1/2"x3/4"		200 / 400	0,2	10
1/2"x3/4"		260 / 520	0,2	10
3/4"x3/4"		75 / 130	0,2	10
3/4"x3/4"		100 / 200	0,2	10
3/4"x3/4"		200 / 400	0,2	10
3/4"x3/4"		260 / 520	0,2	10
3/4"x3/4"		500 / 1000	0,2	10
3/4"x3/4"		750 / 1500	0,2	10
3/4"x3/4"		1000 / 2000	0,2	10
1"x1"		75 / 130	0,25	10
1"x1"		100 / 200	0,25	10
1"x1"		200 / 400	0,25	10
1"x1"		260 / 520	0,25	10
1"x1"		500 / 1000	0,25	10
1"x1"		750 / 1500	0,25	10
1"x1"		1000 / 2000	0,25	10
1.1/4"x1.1/4"		100 / 200	0,25	10
1.1/4"x1.1/4"		200 / 400	0,25	10
1.1/2"x1.1/2"		200 / 400	0,25	10

**Art.6505**

Flessibile estensibile M.F. **con** rivestimento bianco

*Extensible flexible connection M.F. **with** white coating*



UNI CIG 7129

- Pressione in ingresso max : 10 bar
  - Temperatura max : 125 °C
  - Soffietto : AISI 304
  - Dado : ottone nichelato
  - Raccordo : AISI 304
  - Guarnizione : NBR
- *Pressure in : 10 bar*
  - *Max temperature : 125 °C*
  - *Hose : AISI 304*
  - *Nut : Nickel plated brass*
  - *Fitting : AISI 304*
  - *Gasket : NBR*

Misura	M.F.	L min / L max	s	
1/2"x1/2"		100 / 200	0,2	10
1/2"x1/2"		200 / 400	0,2	10
1/2"x3/4"		100 / 200	0,2	10
1/2"x3/4"		200 / 400	0,2	10
3/4"x3/4"		100 / 200	0,2	10
3/4"x3/4"		200 / 400	0,2	10
1"x1"		100 / 200	0,25	10
1"x1"		200 / 400	0,25	10

**Art.6510**

Flessibile estensibile F.F. **senza** rivestimento

*Extensible flexible connection F.F. **without** coating*



Misura	M.F.	L min / L max	s	
1/2"x1/2"		100 / 200	0,2	10
1/2"x1/2"		200 / 400	0,2	10
1/2"x3/4"		100 / 200	0,2	10
1/2"x3/4"		200 / 400	0,2	10
3/4"x3/4"		100 / 200	0,2	10
3/4"x3/4"		200 / 400	0,2	10
1"x1"		75 / 130	0,25	10
1"x1"		100 / 200	0,25	10
1"x1"		200 / 400	0,25	10

## FLESSIBILE ESTENSIBILE INOX PER GAS

### INOX EXTENSIBLE FLEXIBLE GAS CONNECTION

**Art.6520**Flessibile estensibile M.F. con rivestimento GIALLC *Extensible flexible connection M.F. with YELLOW coating*UNI CIG 9891  
UNI 11353

- Con rivestimento giallo
  - Pressione in ingresso max : 0,5 bar
  - Temperatura max : 125 °C
  - Soffietto : AISI 304
  - Dado : ottone nichelato
  - Rivestimento quaina : PE
  - Raccordo : AISI 304
  - Guarnizione : NBR
- *With yellow coating*
  - *Pressure in : 0,5 bar*
  - *Max temperature : 125 °C*
  - *Hose : AISI 304*
  - *Nut : Nickel plated brass*
  - *Cover : PE coating*
  - *Fitting : AISI 304*
  - *Gasket : NBR*

La copertura in PE è non infiammabile e retraibile. Protegge il flessibile contro la corrosione il fuoco e il danneggiamento meccanico

*The cover in PE is non-flammable and shrinkable. It protects the hose against corrosion, fire and mechanical damages*

Utilizzo :  
GPL, gas, boiler  
caldaia, cucina

*Use :*  
*LPG, natural gas, boiler  
heater, kitchen*

Misura M.F.	L min / L max	s	
1/2"x1/2"	75 / 130	0,2	10
1/2"x1/2"	100 / 200	0,2	10
1/2"x1/2"	200 / 400	0,2	10
1/2"x1/2"	260 / 480	0,2	10
1/2"x3/4"	75 / 130	0,2	10
1/2"x3/4"	100 / 200	0,2	10
1/2"x3/4"	200 / 400	0,2	10
1/2"x3/4"	260 / 480	0,2	10
3/4"x3/4"	75 / 130	0,2	10
3/4"x3/4"	100 / 200	0,2	10
3/4"x3/4"	200 / 400	0,2	10
3/4"x3/4"	260 / 480	0,2	10
3/4"x3/4"	500 / 1000	0,2	10
3/4"x3/4"	750 / 1500	0,2	10
3/4"x3/4"	1000 / 2000	0,2	10
1"x1"	75 / 130	0,25	10
1"x1"	100 / 200	0,25	10
1"x1"	200 / 400	0,25	10
1"x1"	260 / 520	0,25	10
1"x1"	500 / 1000	0,25	10
1"x1"	750 / 1500	0,25	10
1"x1"	1000 / 2000	0,25	10

**Art.6525**Flessibile estensibile F.F. con rivestimento giallo *Extensible flexible connection F.F. with yellow coating*

Misura F.F.	L min / L max	s	
1/2"x1/2"	100 / 200	0,2	10
1/2"x1/2"	200 / 400	0,2	10
1/2"x3/4"	100 / 200	0,2	10
1/2"x3/4"	200 / 400	0,2	10
3/4"x3/4"	100 / 200	0,2	10
3/4"x3/4"	200 / 400	0,2	10
1"x1"	100 / 200	0,25	10
1"x1"	200 / 400	0,25	10

## FLESSIBILE PER ALLACCIAMENTO CUCINA

### FLEXIBLE FOR KITCHEN CONNECTION

**Art.6530**

Flessibile per allacciamento cucina M.F.

*Flexible for kitchen connection M.F.*



Misura M.F.	L (mm)	
1/2" X 500	500	10
1/2" X 750	750	10
1/2" X 1000	1000	10
1/2" X 1250	1250	10
1/2" X 1500	1500	10
1/2" X 2000	2000	10

EN 14800

- Pressione in ingresso max : 10 bar
- Range temperatura : -40°C + 125 °C
- Soffietto : AISI 304
- Dado : ottone nichelato
- Raccordo : AISI 304
- Guarnizione : NBR
- Copertura : PVC giallo
- Ø int : 12 mm
- Ø ext : 16 mm

- *Max inlet pressure : 10 bar*
- *Range temperature : -40°C + 125 °C*
- *Hose : AISI 304*
- *Nut : Nickel plated brass*
- *Fitting : AISI 304*
- *Gasket : NBR*
- *Cover : yellow PVC*
- *Ø int : 12 mm*
- *Ø ext : 16 mm*

Utilizzo :  
GAS e GPL

*Use :*  
*Gas and LPG*

**Art.6535**

Flessibile per allacciamento cucina F.F.

*Flexible for kitchen connection F.F.*



Misura F.F.	L (mm)	
1/2" X 500	500	10
1/2" X 750	750	10
1/2" X 1000	1000	10
1/2" X 1250	1250	10
1/2" X 1500	1500	10
1/2" X 2000	2000	10

EN 14800

- Pressione in ingresso max : 10 bar
- Range temperatura : -40°C + 125 °C
- Soffietto : AISI 304
- Dado : ottone nichelato
- Raccordo : AISI 304
- Guarnizione : NBR
- Copertura : PVC giallo
- Ø int : 12 mm
- Ø ext : 16 mm

- *Max inlet pressure : 10 bar*
- *Range temperature : -40°C + 125 °C*
- *Hose : AISI 304*
- *Nut : Nickel plated brass*
- *Fitting : AISI 304*
- *Gasket : NBR*
- *Cover : yellow PVC*
- *Ø int : 12 mm*
- *Ø ext : 16 mm*

Utilizzo :  
GAS e GPL

*Use :*  
*Gas and LPG*





## TUBO CORRUGATO PER ACQUA E GAS

### CORRUGATED TUBE FOR WATER AND GAS

**Art.6550**

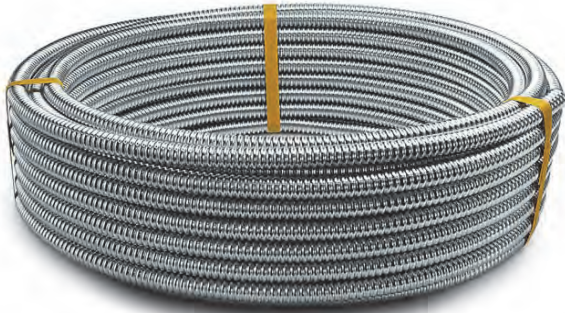
Tubo per acqua pieghevole corrugato

*Corrugated stainless steel tubing for water*

Misura	DN	s	Ø INT	Ø EXT	
1/2" X 5 Mt	12	0,2	13,5	17	5m
1/2" X 10 Mt	12	0,2	13,5	17	10m
1/2" X 25 Mt	12	0,2	13,5	17	25m
1/2" X 50 Mt	12	0,2	13,5	17	50m
3/4" X 5 Mt	18	0,25	17,6	21	5m
3/4" X 10 Mt	18	0,25	17,6	21	10m
3/4" X 25 Mt	18	0,25	17,6	21	25m
3/4" x 50 Mt	18	0,25	17,6	21	50m
1" X 5 Mt	20	0,25	20	24	5m
1" X 10 Mt	20	0,25	20	24	10m
1" X 25 Mt	20	0,25	20	24	25m
1" X 50 Mt	20	0,25	20	24	50m

- Pressione di esercizio : 10 bar
- Range temperatura : -40°C + 125°C
- Soffietto : AISI 304
- Working pressure : 10 bar
- Range temperature : -40°C + 125 °C
- Hose : AISI 304

Utilizzo :

*Use :*Applicazione sanitaria, serbatoi  
boiler e caldaie*Sanitary applications, tank  
boiler and heater***Art.6555**

Tubo gas pieghevole corrugato EN 15266

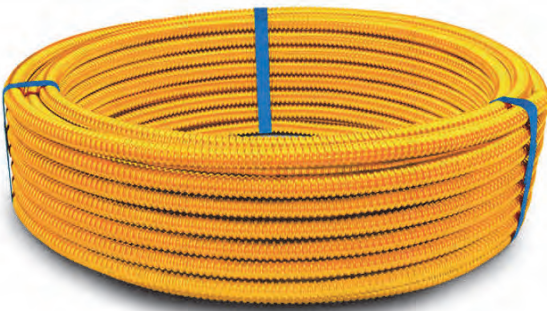
*Corrugated stainless steel tubing for gas EN 15266*

Misura	DN	s	Ø INT	Ø EXT	
1/2" X 5 Mt	13	0,2	13	16,8	5m
1/2" X 10 Mt	13	0,2	13	16,8	10m
1/2" X 25 Mt	13	0,2	13	16,8	25m
1/2" X 50 Mt	13	0,2	13	16,8	50m
3/4" X 5 Mt	15	0,2	14,5	20	5m
3/4" X 10 Mt	15	0,2	14,5	20	10m
3/4" X 25 Mt	15	0,2	14,5	20	25m
3/4" x 50 Mt	15	0,2	14,5	20	50m

**EN 15266**

- Con rivestimento giallo
- Pressione in ingresso max : 0,5 bar
- Range temperatura : -40°C + 125°C
- Copertura : PVC resistente ai raggi UV
- With yellow coating
- Pressure in : 0,5 bar
- Range temperature : -40°C + 125 °C
- Cover : PVC with UV resistance

Utilizzo :

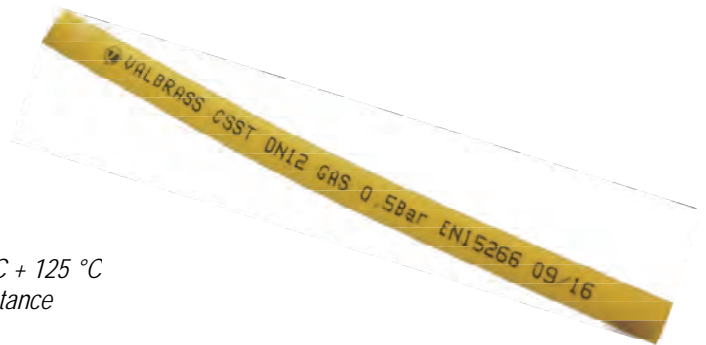
*Use :*impianto domestico distribuzione gas,  
boiler, caldaia , piano di cottura*Domestic gas distribution system,  
boiler, stove*

**Art.6570**

Niplo cilindrico, SEDE PIANA

*Cylindrical nipple, FLAT SEAT*

 In ottone nichelato  
*In nickel plated brass*
**PER ACQUA**
**FOR WATER**

Misura	
1/2"	10
3/4"	10
1"	10

**Art.6571**

Niplo conico da un lato, SEDE PIANA

*Conical nipple one side, FLAT SEAT*

 In ottone nichelato  
*In nickel plated brass*
**PER GAS / ACQUA**
**FOR GAS / WATER**

Misura	
1/2"	10
3/4"	10
1"	10

**Art.6575**

Dado con guarnizione NBR

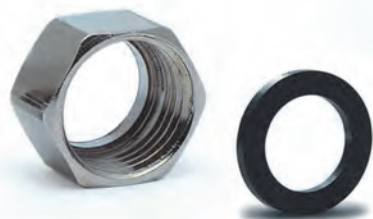
*Nut with NBR gasket*

 In ottone nichelato  
*In nickel plated brass*
**PER GAS**
**FOR GAS**

Misura	
1/2"	10
3/4"	10
1"	10

**Art.6576**

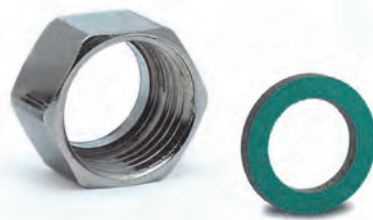
Dado con guarnizione KLINGERSIL

*Nut with KLINGERSIL gasket*

 In ottone nichelato  
*In nickel plated brass*
**PER ACQUA / SOLARE**
**FOR WATER / SOLAR USE**

Misura	
1/2"	10
3/4"	10
1"	10

**Art.6000**

Flessibile Treccia 7 fili inox M.F.

*Flexible M.F., 7 wires in stainless steel*

Misura M.F.	
3/8"x3/8"x15	10
3/8"x3/8"x20	10
3/8"x3/8"x25	10
3/8"x3/8"x30	10
3/8"x3/8"x35	10
3/8"x3/8"x40	10
3/8"x3/8"x45	10
3/8"x3/8"x50	10
3/8"x3/8"x55	10
3/8"x3/8"x60	10
3/8"x3/8"x65	10
3/8"x3/8"x70	10
3/8"x3/8"x100	10
3/8"x1/2"x15	10
3/8"x1/2"x20	10
3/8"x1/2"x25	10
3/8"x1/2"x30	10
3/8"x1/2"x35	10
3/8"x1/2"x40	10
3/8"x1/2"x45	10
3/8"x1/2"x50	10
3/8"x1/2"x55	10
3/8"x1/2"x60	10
3/8"x1/2"x65	10
3/8"x1/2"x70	10
3/8"x1/2"x100	10
1/2"x3/8"x15	10
1/2"x3/8"x20	10
1/2"x3/8"x25	10
1/2"x3/8"x30	10
1/2"x3/8"x35	10
1/2"x3/8"x40	10
1/2"x3/8"x45	10
1/2"x3/8"x50	10
1/2"x3/8"x55	10
1/2"x3/8"x60	10
1/2"x3/8"x65	10
1/2"x3/8"x70	10
1/2"x3/8"x100	10
1/2"x1/2"x15	10
1/2"x1/2"x20	10
1/2"x1/2"x25	10
1/2"x1/2"x30	10
1/2"x1/2"x35	10
1/2"x1/2"x40	10
1/2"x1/2"x45	10
1/2"x1/2"x50	10
1/2"x1/2"x55	10
1/2"x1/2"x60	10
1/2"x1/2"x65	10
1/2"x1/2"x70	10
1/2"x1/2"x100	10

Misura M.F.	
1/2"x3/4"x15	10
1/2"x3/4"x20	10
1/2"x3/4"x25	10
1/2"x3/4"x30	10
1/2"x3/4"x35	10
1/2"x3/4"x40	10
1/2"x3/4"x45	10
1/2"x3/4"x50	10
1/2"x3/4"x55	10
1/2"x3/4"x60	10
1/2"x3/4"x65	10
1/2"x3/4"x70	10
1/2"x3/4"x100	10
3/4"x1/2"x15	10
3/4"x1/2"x20	10
3/4"x1/2"x25	10
3/4"x1/2"x30	10
3/4"x1/2"x35	10
3/4"x1/2"x40	10
3/4"x1/2"x45	10
3/4"x1/2"x50	10
3/4"x1/2"x55	10
3/4"x1/2"x60	10
3/4"x1/2"x65	10
3/4"x1/2"x70	10
3/4"x1/2"x100	10
3/4"x3/4"x15	10
3/4"x3/4"x20	10
3/4"x3/4"x25	10
3/4"x3/4"x30	10
3/4"x3/4"x35	10
3/4"x3/4"x40	10
3/4"x3/4"x45	10
3/4"x3/4"x50	10
3/4"x3/4"x55	10
3/4"x3/4"x60	10
3/4"x3/4"x65	10
3/4"x3/4"x70	10
3/4"x3/4"x100	10



**Art.6005**

Flessibile Treccia 7 fili inox F.F.

*Flexible F.F. , 7 wires in stainless steel*

Misura F.F.	
3/8"x3/8"x15	10
3/8"x3/8"x20	10
3/8"x3/8"x25	10
3/8"x3/8"x30	10
3/8"x3/8"x35	10
3/8"x3/8"x40	10
3/8"x3/8"x45	10
3/8"x3/8"x50	10
3/8"x3/8"x55	10
3/8"x3/8"x60	10
3/8"x3/8"x65	10
3/8"x3/8"x70	10
3/8"x3/8"x100	10
3/8"x1/2"x15	10
3/8"x1/2"x20	10
3/8"x1/2"x25	10
3/8"x1/2"x30	10
3/8"x1/2"x35	10
3/8"x1/2"x40	10
3/8"x1/2"x45	10
3/8"x1/2"x50	10
3/8"x1/2"x55	10
3/8"x1/2"x60	10
3/8"x1/2"x65	10
3/8"x1/2"x70	10
3/8"x1/2"x100	10
1/2"x1/2"x15	10
1/2"x1/2"x20	10
1/2"x1/2"x25	10
1/2"x1/2"x30	10
1/2"x1/2"x35	10
1/2"x1/2"x40	10
1/2"x1/2"x45	10
1/2"x1/2"x50	10
1/2"x1/2"x55	10
1/2"x1/2"x60	10
1/2"x1/2"x65	10
1/2"x1/2"x70	10
1/2"x1/2"x100	10

**Art.6010**

Flessibile Treccia 7 fili inox M.M.

*Flexible M.M. , 7 wires in stainless steel*

Misura M.M.	
3/8"x3/8"x10	10
3/8"x3/8"x12	10
3/8"x3/8"x15	10
3/8"x3/8"x20	10
3/8"x3/8"x25	10
1/2"x3/8"x10	10
1/2"x3/8"x12	10
1/2"x3/8"x15	10
1/2"x3/8"x20	10
1/2"x3/8"x25	10
1/2"x1/2"x10	10
1/2"x1/2"x12	10
1/2"x1/2"x15	10
1/2"x1/2"x20	10
1/2"x1/2"x25	10



**Art.6100**

Antivibrante per autoclave in gomma EPDM

*Big flexible with EPDM rubber*T : acqua fredda max 50°C / *cold water max 50°C*

Misura M.F.	
1/2"x25	10
1/2"x30	10
1/2"x35	10
1/2"x40	10
1/2"x45	10
1/2"x50	10
1/2"x60	10
1/2"x70	10
1/2"x80	10
1/2"x90	10
1/2"x100	10
3/4"x25	10
3/4"x30	10
3/4"x35	10
3/4"x40	10
3/4"x45	10
3/4"x50	10
3/4"x60	10
3/4"x70	10
3/4"x80	10
3/4"x90	10
3/4"x100	10
1"x25	10
1"x30	10
1"x35	10
1"x40	10
1"x45	10
1"x50	10
1"x60	10
1"x70	10
1"x80	10
1"x90	10
1"x100	10

Misura M.F.	
1.1/4"x25	10
1.1/4"x30	10
1.1/4"x35	10
1.1/4"x40	10
1.1/4"x45	10
1.1/4"x50	10
1.1/4"x60	10
1.1/4"x70	10
1.1/4"x80	10
1.1/4"x90	10
1.1/4"x100	10
1.1/2"x25	10
1.1/2"x30	10
1.1/2"x35	10
1.1/2"x40	10
1.1/2"x45	10
1.1/2"x50	10
1.1/2"x60	10
1.1/2"x70	10
1.1/2"x80	10
1.1/2"x90	10
1.1/2"x100	10
2"x25	10
2"x30	10
2"x35	10
2"x40	10
2"x45	10
2"x50	10
2"x60	10
2"x70	10
2"x80	10
2"x90	10
2"x100	10





**Art.6105**

Antivibrante per autoclave in gomma EPDM

*Big flexible with EPDM rubber*

T : acqua calda max 100°C / hot water max 100°C

Misura M.F.	
1/2"x25	10
1/2"x30	10
1/2"x35	10
1/2"x40	10
1/2"x45	10
1/2"x50	10
1/2"x60	10
1/2"x70	10
1/2"x80	10
1/2"x90	10
1/2"x100	10
3/4"x25	10
3/4"x30	10
3/4"x35	10
3/4"x40	10
3/4"x45	10
3/4"x50	10
3/4"x60	10
3/4"x70	10
3/4"x80	10
3/4"x90	10
3/4"x100	10
1"x25	10
1"x30	10
1"x35	10
1"x40	10
1"x45	10
1"x50	10
1"x60	10
1"x70	10
1"x80	10
1"x90	10
1"x100	10

Misura M.F.	
1.1/4"x25	10
1.1/4"x30	10
1.1/4"x35	10
1.1/4"x40	10
1.1/4"x45	10
1.1/4"x50	10
1.1/4"x60	10
1.1/4"x70	10
1.1/4"x80	10
1.1/4"x90	10
1.1/4"x100	10
1.1/2"x25	10
1.1/2"x30	10
1.1/2"x35	10
1.1/2"x40	10
1.1/2"x45	10
1.1/2"x50	10
1.1/2"x60	10
1.1/2"x70	10
1.1/2"x80	10
1.1/2"x90	10
1.1/2"x100	10
2"x25	10
2"x30	10
2"x35	10
2"x40	10
2"x45	10
2"x50	10
2"x60	10
2"x70	10
2"x80	10
2"x90	10
2"x100	10

**Art.6110**

Antivibrante con curva in ottone

*Big flexible with elbow, EPDM rubber*

T : acqua fredda max 50°C / cold water max 50°C

Misura	
3/4"x40	10
3/4"x50	10
3/4"x60	10
3/4"x80	10
3/4"x100	10
1"x40	10
1"x50	10
1"x60	10
1"x80	10
1"x100	10

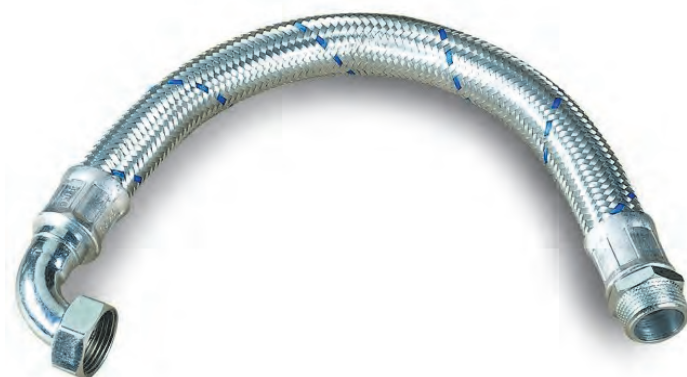

**Art.6115** Antivibrante con curva in ottone

*Big flexible with elbow, EPDM rubber*

T : acqua calda max 100°C / hot water max 100°C

Misura	
3/4"x40	10
3/4"x50	10
3/4"x60	10
3/4"x80	10
3/4"x100	10
1"x40	10
1"x50	10
1"x60	10
1"x80	10
1"x100	10



**Art.6130** Tubo lavatrice treccia INOX 304

*Washing machine pipe in stainless steel AISI 304*



	Misura	
	F.F. 3/4"x100	10
	F.F. 3/4"x150	10
	F.F. 3/4"x200	10
	F.F. 3/4"x250	10
	F.F. 3/4"x300	10
con curva with elbow	F.C 3/4"x100	10
	F.C 3/4"x150	10
	F.C 3/4"x200	10
	F.C 3/4"x250	10
	F.C 3/4"x300	10

**Art.6135** Tubo lavatrice in gomma, racc. in plastica

*Washing machine rubber pipe, plastic fittings*



	Misura	
	F.F. 3/4"x100	10
	F.F. 3/4"x150	10
	F.F. 3/4"x200	10
	F.F. 3/4"x250	10
	F.F. 3/4"x300	10
con curva with elbow	F.C 3/4"x100	10
	F.C 3/4"x150	10
	F.C 3/4"x200	10
	F.C 3/4"x250	10
	F.C 3/4"x300	10
	M.F. 3/4"x100	10
	M.F. 3/4"x150	10
	M.F. 3/4"x200	10
	M.F. 3/4"x250	10
	M.F. 3/4"x300	10

**PER ALTRI FLESSIBILI NON A CATALOGO CONTATTATECI, LI REALIZZIAMO SU MISURA !**

**FOR OTHER FLEXIBLES NOT IN THE CATALOGUE PLEASE CONTACT US, WE MAKE AS YOU REQUIRE !**

**Art.410/F** Rubinetto portag. a sfera curvo

*Curved ball tap with handle*

Misura	A	C	E	D	gr.		
1/2"	1/2"	134	15	85	150	22	88

Con farfalla in Alluminio rossa  
 With aluminium red T handle

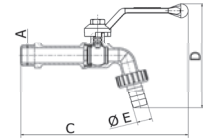

**Art.410** Rubinetto portagomma a sfera curvo

*Curved ball tap with handle*

Misura	A	C	E	D	gr.		
1/2"	1/2"	143	15	89	191	18	72
3/4"	3/4"	150	20	102	282	6	72
1"	1"	160	25	111	434	6	48

Con maniglia in Acciaio cromato  
 rivestita in gomma rossa

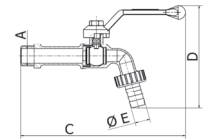
*With steel handle red rubber covered*



**Art.410/A** Disponibile anche con attacco rapido  
 Available also with rapid attack



**Art.410/N** con maniglia in alluminio nera  
 with black aluminium handle

**Art.410/N/A** Disponibile con attacco rapido  
 Available also with rapid attack



**Art.410/B** con maniglia in alluminio blu  
 with blue aluminium handle

**Art.410/B/A** Disponibile con attacco rapido  
 Available also with rapid attack



**Art.410/R** con maniglia in alluminio rossa  
 with red aluminium handle



**Art.410/R/A** Disponibile con attacco rapido  
 Available also with rapid attack





**Art.320** Rubinetto portag. a sfera curvo PESANTE *HEAVY curved ball tap with hose ring*



Misura	A	C	E	D	gr.		
3/8"	3/8"	138	15	90	218	8	90
1/2"	1/2"	148	15	90	261	8	96
3/4"	3/4"	149	20	102	338	6	72
1"	1"	160	25	111	434	6	48

Con maniglia in Acciaio cromato rivestita in gomma rossa

*With steel handle red rubber covered*

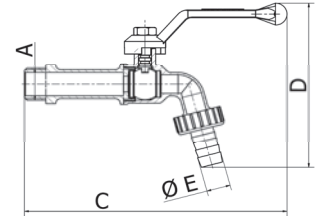

↳ **Art.320/A** Disponibile anche con attacco rapido  
*Available also with rapid attack*



**Art.320/N** con maniglia in alluminio nera  
*with black aluminium handle*

**Art.320/N/A** Disponibile con attacco rapido  
*Available also with rapid attack*



**Art.320/B** con maniglia in alluminio blu  
*with blue aluminium handle*

**Art.320/B/A** Disponibile con attacco rapido  
*Available also with rapid attack*



**Art.320/B/V** con maniglia in alluminio verde  
*with green aluminium handle*

**Art.320/B/V/A** Disponibile con attacco rapido  
*Available also with rapid attack*



**Art.320/B/R** con maniglia in alluminio rossa  
*with red aluminium handle*

**Art.320/B/R/A** Disponibile con attacco rapido  
*Available also with rapid attack*



**Art.321** Rubinetto portag. a sfera curvo PESANTE *HEAVY curved ball tap with hose ring*

Misura	A	B	C	E	D	gr.		
1/2"	1/2"	3/4"	155	15	90	352	5	60

Con maniglia in Acciaio cromato rivestita in gomma rossa

*With steel handle red rubber covered*

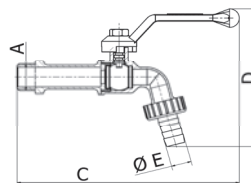

Art.321/A Disponibile anche con attacco rapido  
*Available also with rapid attack*



Art.321/N con maniglia in alluminio nera  
*with black aluminium handle*

Art.321/N/A Disponibile con attacco rapido  
*Available also with rapid attack*



Art.321/B con maniglia in alluminio blu  
*with blue aluminium handle*

Art.321/B/A Disponibile con attacco rapido  
*Available also with rapid attack*



Art.321/C con maniglia in alluminio cromata  
*with chrome plated aluminium handle*

Art.321/C/A Disponibile con attacco rapido  
*Available also with rapid attack*

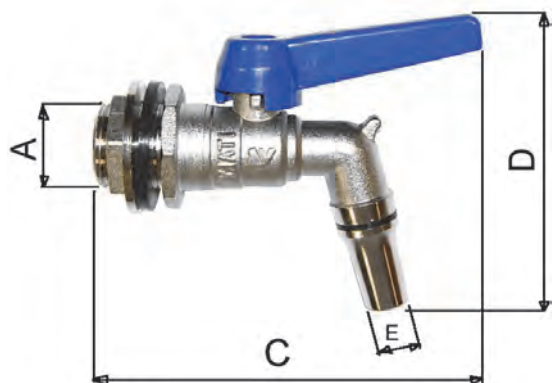
**Art.330** Rubinetto a sfera curvo per botti *Tank bibcock*

Misura	A	C	E	D	gr.		
1/2"	1/2"	109	11	87	206	10	120
3/4"	3/4"	109	14	87	316	10	72

Adatto per botti sia in cemento che in vetroresina, con controdamo e guarnizione

*With nut and gasket, for wine cask*

Disponibile versione in INOX AISI 316 Art.2331

**AVAILABLE IN STAINLESS STEEL AISI 316 Art.2331**

**Art.412** Rubinetto portagomma a sfera lucchettabile *Padlock-bibcock*



Misura	A	C	E	D	gr.		
1/2"	1/2"	121	15	92	190	10	100
3/4"	3/4"	120	15	92	206	10	100

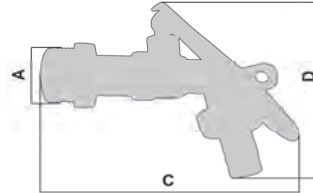

**Art.478** Rubinetto a sfera curvo

*Curved ball tap*

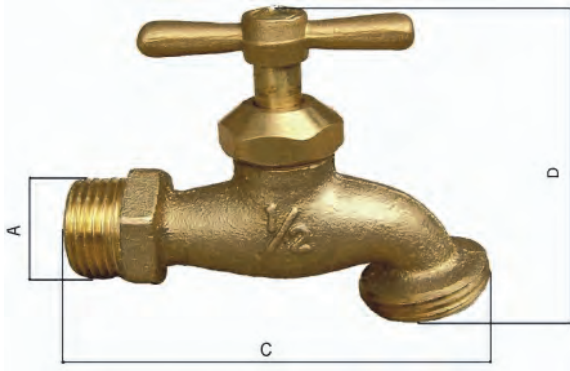

Misura	A	C	D	gr.		
1/2"	1/2"	81	62	158	12	120

**Art.351/A**

Misura	gr.		
3/4" NH	20	12	120



**Art.775** Rubinetto d'arresto piombabile

*Lockable stop valve*



Con chiave di manovra  
*With key handle*

Misura	A	C	D	W	gr.		
1/2"	1/2"	51	55	25	190	12	12

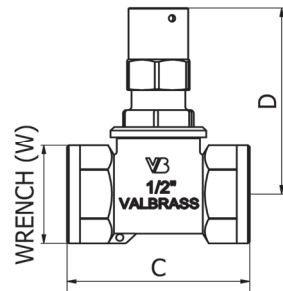

**Art.776** Rubinetto d'arresto con maniglia

*Stop valve with lever*

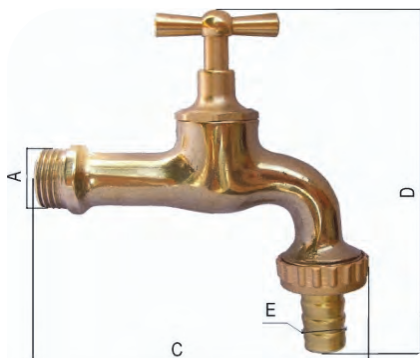

Misura	A	gr.		
1/2"	1/2"	180	12	12

**Art.570** Rubinetto portagomma in ottone lucidato *Curved polished tap*

Misura	A	C	E	D	gr.		
1/2"	1/2"	113	15	111	214	6	72
3/4"	3/4"	118	20	116	289	5	5



Disponibile versione con chiave di manovra  
**Art.570/K**

Available also with key handle  
**Art.570/K**

**Art.567** Rubinetto portagomma lucidato **PESANTE** *HEAVY curved polished tap*

Misura	A	C	E	D	gr.		
3/8"	3/8"	115	15	116	300	10	10
1/2"	1/2"	112	15	115	250	6	72
3/4"	3/4"	126	20	149	457	5	5
1"	1"	160	25	157	675	1	1

**Art.567/S** Rubinetto portagomma sabbiato **PESANTE** *Heavy Curved sandblasted tap*

Misura	A	C	E	D	gr.		
3/8"	3/8"	115	15	116	300	10	10
1/2"	1/2"	112	15	115	250	6	72
3/4"	3/4"	126	20	149	457	5	5
1"	1"	160	25	157	675	1	1

**Art.567/C** Rubin. portag. in ottone lucidato e cromato *Curved chromium plated polished tap*



Misura	A	C	E	D	gr.		
1/2"	1/2"	112	15	115	250	6	72

**Art.1800**

Rubinetto esagonale, maniglia a croce

*Hexagonal bibcock with cross handle*

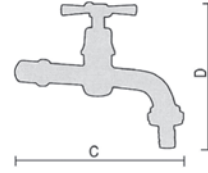
Misura	C	D	gr.	
1/2"	140	120	607	1

**Art.1801**

Rubin. esagonale, maniglia "Pompeana"

*Hexagonal bibcock with "Pompeana" handle*

Misura	C	D	gr.	
1/2"	140	140	553	1

**Art.1802**

Rubinetto maniglia "Galletto"

*Bibcock with "Chicken" handle*

Misura	C	D	gr.	
1/2"	107	140	336	1

**Art.1805**

Rubinetto antico brunito con volantino

*Bronzed bibcock with handwheel*

Misura	C	D	gr.	
1/2"	160	100	689	1

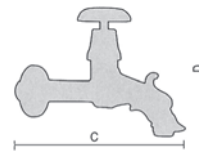
**Art.1806**

Rubinetto con volantino antico

*Antiqued bibcock with handwheel*

Misura	C	D	gr.	
1/2"	160	100	643	1

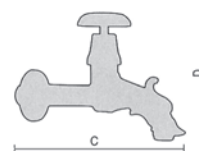

**Art.569/G** Rubinetto a cartuccia ceramica

*Bibcock with cartridge*

Misura	C	D	gr.	
1/2"	160	100	563	1

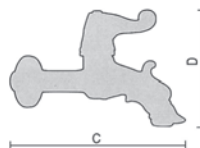
**Art.569/B** Rubinetto pesante anticato

*Heavy antiqued bibcock*

Misura	C	D	gr.	
1/2"	160	100	598	1

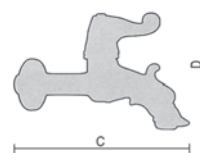
**Art.569/BC** Rubinetto pesante anticato corto

*Heavy antiqued bibcock*

Misura	C	D	gr.	
1/2"	123	100	485	1

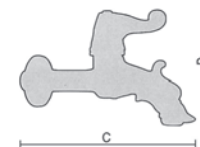
**Art.572** Rubinetto lucido con reggi-secchio

*Polished Bibcock with support bucket*

Misura	A	B	C	D	gr.	
1/2"	133	120	78	27	621	1

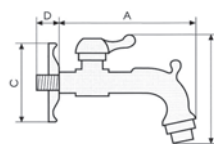
**Art.568** Rubinetto temporeggiato (15 secondi)

*Stall bibcock (15 seconds)*

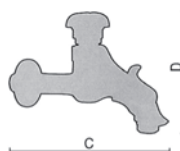

Misura	C	D	gr.	
1/2"	16	10	688	1



**Art.573** Rubinetto a pulsante semplice

*Bibcock with push button*

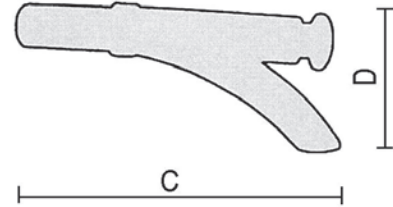
Misura	C	D	gr.	
1/2"	14	6	454	1

**Art.1826** Rubinetto a pulsante temporizzato

*Temporised tap*

Misura	gr.	
1/2"	528	1

Con anti-colpo d'ariete  
Regolabile in lunghezza

*Shock resistant system  
Adjustable length*

**Art.1827** Rubinetto a pulsante

*Bibcock with push button*

Misura	gr.	
1/2"	394	1

**Art.1855** Bocca

*Orifice*

Misura	C	D	gr.	
1/2"	148	70	296	1

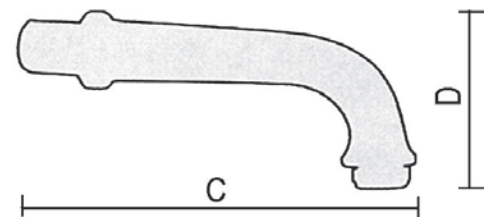

**Art.1901** Rosetta ø 54 anticata

*Antiqued rosette ø54*

Misura	gr.	
	50	1

**Art.1902** Rosetta ø 54 spazzolata

*Polished rosette ø 54*

Misura	gr.	
	53	1

**Art.1903** Rosetta ø 54 bronzata

*Bronzed rosette ø 54*

Misura	gr.	
	50	1

**Art.1904** Rosetta ø 59,5

*Rosette ø 59,5*

Misura	gr.	
	65	1

**Art.1906** Rosetta dorata ø 72

*Gilded rosette ø 72*

Misura	gr.	
	94	1

**Art.1907** Rosetta fiore anticata ø 84

*Antiqued flower rosette ø 84*

Misura	gr.	
	90	1



## ISTRUZIONI PER IL CORRETTO MONTAGGIO

### *Assembling instructions*

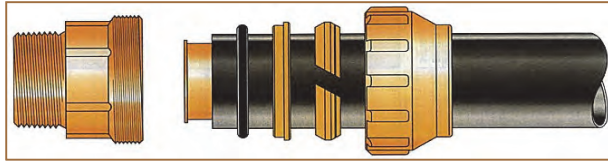

- Il taglio del tubo deve essere perpendicolare ed effettuato con apposito utensile verificando che la lama si presenti sempre con filo tagliente
- Eliminare eventuali residui di bava sul tubo che possano danneggiare la guarnizione
- Pulire accuratamente il tubo ed eventuali elementi che possano pregiudicare la tenuta
- Senza smontare gli elementi assemblati del raccordo infilare il tubo nella propria sede. Fare in modo che il tubo non penetri fino in battuta sul raccordo, ma lasciare sempre qualche millimetro di agio per assestamento del tubo. Infine serrare la ghiera come da tabella
- Riverificare la coppia di montaggio dopo 24 H dall'installazione per compensare la deformazione del tubo e della guarnizione

- 
- *Cut the pipe perpendicular with the proper tool by checking that the blade is always sharp.*
  - *Eliminate any burrs on the pipe which could cut the o-rings.*
  - *Clean carefully the pipe from any elements which could compromise the hydraulic resistance*
  - *Without disassembling the fitting insert the pipe in its place*
- Do not insert the pipe up to the end of the inner part of the fitting, leave always some millimeters for the pipe settling. Tighten the nut according to the table*
- Check the assembling after 24 hours from installation in order to compensate pipe and O-Ring deformation*

$\varnothing$ Tubo <i><math>\varnothing</math> pipe</i>	Coppia Nm
20	25
25	34
32	44
40	55
50	60
63	130

---

**Art.1000** Raccordo giunzione maschio

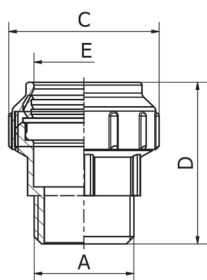
*Straight male fitting*

\* Flangiate  
\* Flanged

Misura	A	C	E	D	gr.		
1/2" x 20	1/2"	34	20	46	90	20	200
3/4" x 25	3/4"	40	25	52	116	30	150
1" x 32	1"	47	32	58	202	10	100
1.1/4" x 40	1.1/4"	57	40	75	295	10	50
1.1/2" x 50	1.1/2"	69	50	82	495	6	30
2" x 63	2"	86	63	92	757	6	20
* 2.1/2" x 75	2.1/2"	98	75	102	1672	1	1
* 3" x 90	3"		90		1	1	
* 4" x 110	4"		110		1	1	

**Art.1005** Raccordo giunzione femmina

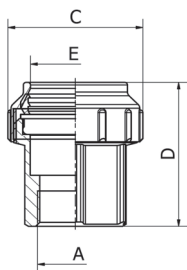
*Straight female fitting*

\* Flangiate  
\* Flanged

Misura	A	C	E	D	gr.		
1/2" x 20	1/2"	34	20	50	89	20	200
3/4" x 25	3/4"	40	25	57	122	30	150
1" x 32	1"	47	32	65	216	20	100
1.1/4" x 40	1.1/4"	57	40	81	324	10	50
1.1/2" x 50	1.1/2"	69	50	82	531	2	30
2" x 63	2"	86	63	96	810	1	20
* 2.1/2" x 75	2.1/2"	98	75		1	1	
* 3" x 90	3"		90		1	1	
* 4" x 110	4"		110		1	1	

**Art.1010** Raccordo giunzione curvo maschio

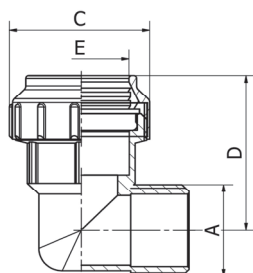
*Male elbow fitting*

\* Flangiate  
\* Flanged

Misura	A	C	E	D	gr.		
1/2" x 20	1/2"	34	20	45	95	15	150
3/4" x 25	3/4"	40	25	55	175	10	100
1" x 32	1"	47	32	61	323	10	50
1.1/4" x 40	1.1/4"	57	40	79	466	3	30
1.1/2" x 50	1.1/2"	69	50	83	746	2	18
2" x 63	2"	86	63	95	1440	1	10
* 2.1/2" x 75	2.1/2"	98	75		1	1	
* 3" x 90	3"		90		1	1	

**Art.1015** Raccordo giunzione curvo femmina

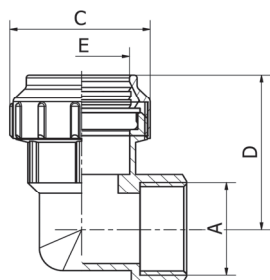
*Female elbow fitting*

\* Flangiate  
\* Flanged

Misura	A	C	E	D	gr.		
1/2" x 20	1/2"	34	20	44	107	15	150
3/4" x 25	3/4"	40	25	50	199	20	100
1" x 32	1"	47	32	55	344	10	50
1.1/4" x 40	1.1/4"	57	40	74	492	5	30
1.1/2" x 50	1.1/2"	69	50	85	845	2	18
2" x 63	2"	86	63	96	1471	1	10
* 2.1/2" x 75	2.1/2"	98	75		1	1	
* 3" x 90	3"		90		1	1	
* 4" x 110	4"		110		1	1	

**Art.1020**

Raccordo giunzione

*Double straight fitting*

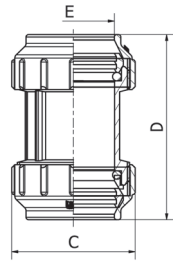

\* Flangiate  
\* Flanged

Misura	E	C	D	gr.		
ø 20	ø 20	33	69	122	30	150
ø 25	ø 25	40	73	192	10	100
ø 32	ø 32	47	84	283	10	60
ø 40	ø 40	57	100	462	4	40
ø 50	ø 50	69	118	797	2	20
ø 63	ø 63	86	130	1101	1	14
* ø 75	ø 75				1	1
* ø 90	ø 90				1	1
* ø 110	ø 110				1	1

**Art.1025**

Raccordo giunzione curvo 90°

*Double elbow fitting*

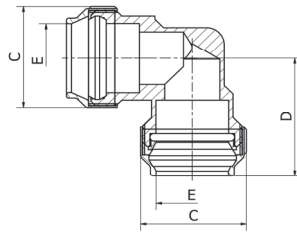

\* Flangiate  
\* Flanged

Misura	E	C	D	gr.		
ø 20	ø 20	33	45	138	30	150
ø 25	ø 25	40	50	277	20	100
ø 32	ø 32	47	64	392	5	50
ø 40	ø 40	57	79	690	5	25
ø 50	ø 50	69	84	996	2	16
ø 63	ø 63	86	94	1673	5	5
* ø 75	ø 75	98			1	1
* ø 90	ø 90				1	1
* ø 110	ø 110				1	1

**Art.1030**

Raccordo giunzione a "T"

*Tee fitting*

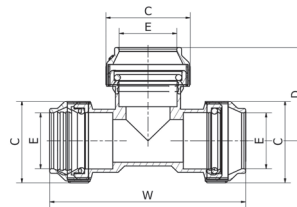

\* Flangiate  
\* Flanged

Misura	E	C	D	W	gr.		
ø 20	ø 20	33	44	86	206	20	100
ø 25	ø 25	40	52	94	370	10	60
ø 32	ø 32	47	60	115	504	3	30
ø 40	ø 40	57	82	145	816	2	18
ø 50	ø 50	69	85	153	1410	1	12
ø 63	ø 63	86	86	185	2243	1	5
* ø 75	ø 75	98				1	1
* ø 90	ø 90					1	1
* ø 110	ø 110					1	1

**Art.1035**

Raccordo giunzione a "T" femmina

*Female tee fitting*

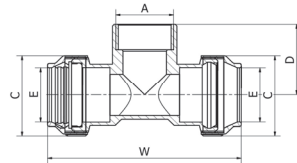

\* Flangiate  
\* Flanged

Misura	A	W	C	E	D	gr.		
1/2" x 20	1/2"	73	35	20	17	156	20	100
3/4" x 25	3/4"	97	41	25	35	316	10	60
1" x 32	1"	109	50	32	40	439	3	30
1.1/4" x 40	1.1/4"	127	59	40	45	832	2	18
1.1/2" x 50	1.1/2"	145	73	50	53	1227	2	12
2" x 63	2"	175	89	63	66	2125	1	6
* 2.1/2" x 75	2.1/2"	98	75	75			1	1
* 3" x 90	3"		90	90			1	1
* 4" x 110	4"		110	110			1	1

**Art.1040**

Raccordo a giunzione a "T"

*Male tee fitting*

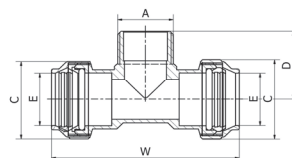

\* Flangiate  
\* Flanged

Misura	A	W	C	E	gr.		
1/2" x 20	1/2"	81	35	20	204	15	15
3/4" x 25	3/4"	95	42	25	328	10	10
1" x 32	1"	118	50	32	430	10	10
1.1/4" x 40	1.1/4"	150	61	40	815	5	5
1.1/2" x 50	1.1/2"	160	74	50	1169	5	5
2" x 63	2"		92	63	1981	5	5

**Art.1050** Raccordo curvo F. con staffa

*Female elbow with wallplate*

Misura	A	C	E	D	gr.		
1/2" x ø 20	1/2"	51	20	66	157	10	100
3/4" x ø 25	3/4"	64	25	77	252	6	60
1" x ø 32	1"	74	32	87	395	3	30

**Art.1055** Bussola di rinforzo per tubi PE classe S5

*Sleeve for PE GAS pipes S5*

**OBBLIGATORIO PER USO GAS**
*OBLIGATORY FOR GAS USE*

Misura	gr.		
ø 20	13	10	50
ø 25	22	10	50
ø 32	25	10	50
ø 40	55	10	30
ø 50	77	10	30
ø 63	119	10	30

**Art.1060** Anello elastico in ottone

*elastic ring in brass*

Misura		
ø 20	25	25
ø 25	25	25
ø 32	25	25
ø 40	10	10
ø 50	10	10
ø 63	10	10

**Art.1060/P** Anello elastico in teflon

*Elastic ring in PTFE*

Misura		
ø 20	25	25
ø 25	25	25
ø 32	25	25
ø 40	10	10
ø 50	10	10
ø 63	10	10

**Art.1065** Anello premi-OR

*Ring in brass*

Misura		
ø 20	25	25
ø 25	25	25
ø 32	25	25
ø 40	10	10
ø 50	10	10
ø 63	10	10

**Art.1070** O-Ring in NBR

*O-Ring in NBR*

Misura		
ø 20	25	25
ø 25	25	25
ø 32	25	25
ø 40	10	10
ø 50	10	10
ø 63	10	10

## RACCORDERIA GENERICA

*Generic fittings*



### Caratteristiche tecniche

*Technical features*

Materiale utilizzato : Ottone CW614N UNI EN 12164  
Ottone CW617N UNI EN 12164

Filettature : ISO 228 / ISO 7

La sezione di raccorderia si suddivide in tre gruppi principali:

- 1) girevoli : utilizzati in campi industriali dove è presente : acqua, olio, gasolio e carburanti in genere
- 2) raccorderia generica : utilizzata in impiantistica e manutenzione industriale, ricambistica generale per l'industria
- 3) raccordi tubo ferro
- 4) camlock : utilizzati per ottenere un collegamento rapido e sicuro tra due tubazioni

*Material used : Brass CW614N UNI EN 12164  
Brass CW617N UNI EN 12164*

*Threads : ISO 228 / ISO 7*

*The fittings section is subdivided in three parts:*

- 1) *swivel connector : utilized with fluids like: water, oil, gasoline and fuel*
- 2) *general fittings: utilized in industrial*
- 3) *fittings for iron tube*
- 4) *camlock couplings: utilized to obtain a quick and safe connection between two lines*

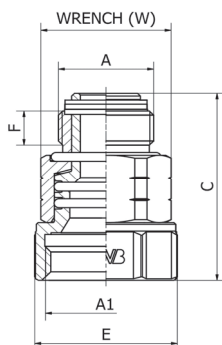
**Art.800**
**Raccordo girevole giallo M.F.**
*Swivel connector M.F.*

Misura	A	A1	F	W	E	C	gr.		
1/2" x 1/2"	1/2"	1/2"	14	25	28	50	111	16	250
3/4" x 3/4"	3/4"	3/4"	14	34	37	52	188	12	120
3/4" x 1"	3/4"	1"	15	33	41	56	200	10	100
1" x 1"	1"	1"	15	33	42	53	251	10	100
3/4" x 1" NPT									
1" x 1" NPT									

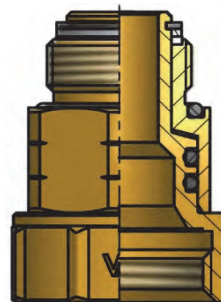

Adatti ad uso gasolio e acqua

*Use: water and diesel fuel*

Su richiesta con guarnizioni in Viton per uso benzina, Art.800/V

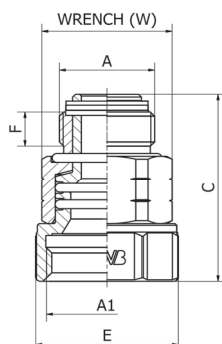
*On request with Viton OR for petrol, Art.800/V*
**Art.801**
**Raccordo girevole cromato M.F.**
*Chromium plated swivel connector M.F.*

Misura	A	A1	F	W	E	C	gr.		
1/2" x 1/2"	1/2"	1/2"	14	25	28	50	111	16	250
3/4" x 3/4"	3/4"	3/4"	14	34	37	52	188	12	120
3/4" x 1"	3/4"	1"	15	33	41	56	200	10	100
1" x 1"	1"	1"	15	33	42	53	251	10	100

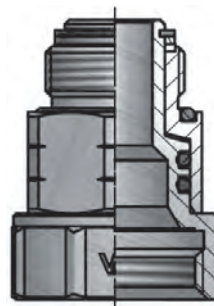

Adatti ad uso gasolio e acqua

*Use: water and diesel fuel*

Su richiesta con guarnizioni in Viton per uso benzina, Art.801/V

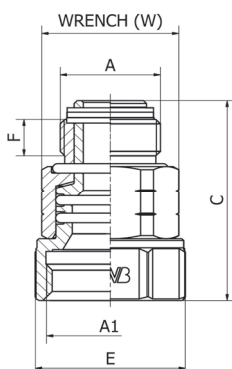
*On request with Viton OR for petrol, Art.801/V*
**Art.2800**
**Raccordo girevole INOX M.F.**
*Stainless steel swivel connector M.F.*

Misura	A	A1	F	W	E	C	gr.		
3/4" x 1"	3/4"	1"	15	33	41	56	195	10	10
1" x 1"	1"	1"	15	33	42	53	245	10	10

**INOX (guarnizioni VITON)**
**STAINLESS STEEL (VITON gaskets)**

**Art.802**

Raccordo girevole giallo M.M.

*Swivel connector M.M.*

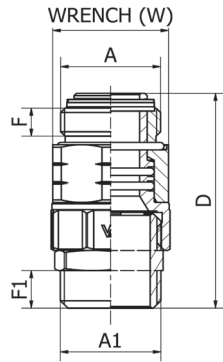

Misura	A	A1	F	F1	W	D	gr.		
3/4" x 1"	3/4"	1"	15	14	33	75	279	50	10
1" x 1"	1"	1"	15	14	33	72	329	20	10

Adatti ad uso gasolio e acqua  
 Con filtro inox 304, mesh 400 µm  
 Su richiesta con guarnizioni in Viton per uso benzina, Art.802/V

*Use: water and diesel fuel  
 With stainless steel 304 filter mesh 400 µm  
 On request with Viton OR for petrol, Art.802/V*

**Art.803**

Raccordo girevole cromato M.M.

*Chromium plated swivel connector M.M.*

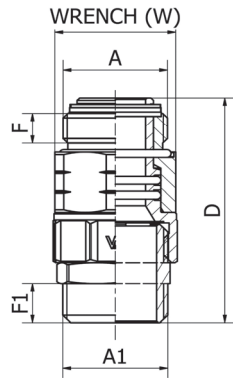

Misura	A	A1	F	F1	W	D	gr.		
3/4" x 1"	3/4"	1"	15	14	33	75	279	50	10
1" x 1"	1"	1"	15	14	33	72	329	20	10

Adatti ad uso gasolio e acqua  
 Con filtro inox 304, mesh 400 µm  
 Su richiesta con guarnizioni in Viton per uso benzina, Art.803/V

*Use: water and diesel fuel  
 With stainless steel 304 filter mesh 400 µm  
 On request with Viton OR for petrol, Art.803/V*

**Art.810**

Raccordo stringitubo maschio

*Male pipe wrench connector*

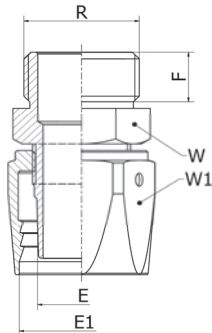

Misura	R	F	E	E1	W	W1	gr.		
3/4"x19x27	3/4"	17	19	28	32	32	197	16	16
1"x19x27	1"	17	19	28	34	32	213	12	12
1"x25x35	1"	17	25	36	34	38	224	10	10

Filetto maschio conico  
*Conic male thread*

**Art.811**

Raccordo stringitubo femmina

*Female pipe wrench connector*

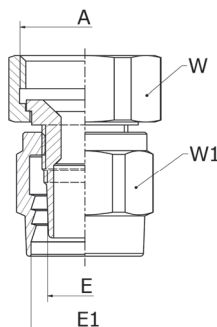

Misura	A	E	E1	W	W1	gr.		
1"x19x27	1"	19	28	36	32	104	10	10
1"x25x35	1"	25	28	36	28	198	10	10

**Art.147** Portagomma maschio con OR

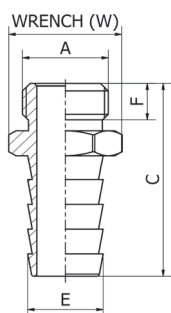
*Male hose connector with OR*

Misura	A	E	F	W	C	gr.		
1/2" x 20	1/2"	20	9	26	40	32	12	576
3/4" x 20	3/4"	20	9	29	39	43	40	480
3/4" x 25	3/4"	25	9	29	46	48	60	240
1" x 20	1"	20	11	34	42	54	28	280
1" x 25	1"	25	11	34	47	63	50	300

**Art.146** Portagomma maschio con OR, PESANTE

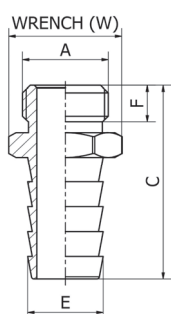
*Male hose connector with OR, HEAVY model*

Misura	A	E	F	W	C	gr.		
3/8" x 14,5	3/8"	14,5	7,5	19	39	27	50	50
3/4" x 19	3/4"	19	11	32	44	65	70	280
3/4" x 25	3/4"	25	11	32	50	84	60	240
1" x 19	1"	19	12	37	46	80	60	240
1" x 25	1"	25	12	37	51	100	45	270
1" x 30	1"	30	12	37	52	100	40	240

**Art.149** Portagomma M. con OR EXTRA pesante

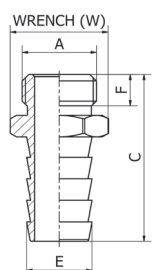
*Male hose connector with OR, EXTRA heavy model*

Con gola di aggrappaggio

*With clamping groove*

Misura	A	E	C	gr.		
3/4" x 19	3/4"	19	51	80	70	280
3/4" x 25	3/4"	25	51	98	60	240
1" x 19	1"	19	52	102	60	240
1" x 25	1"	25	58	122	40	240

**Art.149/NPT**

Misura	A	E	C	gr.		
3/4"NPT x 19	3/4" NPT	19	57	80	70	280
1"NPT x 19	1" NPT	19	58	102	60	240
1"NPT x 25	1" NPT	25	58	122	40	240

**Art.144/AL** Boccola in alluminio

*Aluminium bush*

Misura	FORO		
ø13,5 x ø15	9,5	10	500
ø16 x ø18	42	10	500
ø20 x ø22	14,7	10	500
ø28 x ø30	20	10	500
ø30 x ø32	20	10	500
ø33 x ø35	26	10	500
ø36 x ø38	26	10	500

Altre misure su richiesta

*Ather sizes on request*



**Art.166**

Raccordo a 3 vie **PESANTE**, 72 mm

*Three ways connector **HEAVY**, 72 mm*

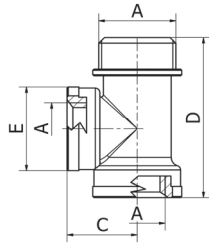

Misura	A	E	C	D	gr.		
1"	1"	38	30	72	181	20	80

**Art.168**

Raccordo 4 vie

*Four way connector*

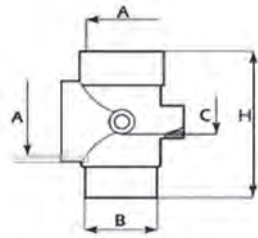

Misura	A	B	C	H	gr.		
1"x 1/4"	1"	1"	1/4"	78	235	10	100

**Art.170**

Raccordo 5 vie

*Five ways connector*

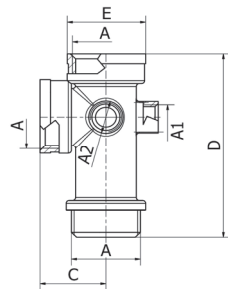

Misura	A	A1	E	C	D	gr.		
1" x 71	1"	1/4"	37	28	71	174	10	80
1" x 80	1"	1/4"	37	28	80	200	15	60
1" x 90	1"	1/4"	37	28	90	230	18	72

**Art.171**

Raccordo 5 vie **PESANTE**, 93 mm

*Five ways connector, **HEAVY** model, 93 mm*

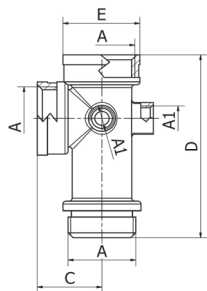

Misura	A	A1	E	C	D	gr.		
1" x 93	1"	1/4"	38	32	93	261	10	60

Con attacco 1/4" F. disassato  
per un migliore alloggiamento del pressostato

**Art.174**

Raccordo 5 vie, 80 mm

*Five way connector, 80 mm*



Misura	A	A1	gr.		
1" x 80	1"	1/4"	204	15	60

**Art.145** Portagomma maschio tipo "Roma"

*One piece Male hose connector*

Portagomma maschio filettato tipo "Roma" con flangia di battuta

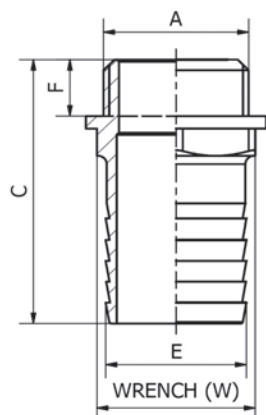

*Male hose connector with flange*

Misura	A	E	F	W	C	gr.		
1/4" x 6	1/4"	6	8	15	32	11	100	3000
1/4" x 8	1/4"	8	8	15	34	14	200	2000
1/4" x 10	1/4"	10	9	15	37	16	10	1600
1/4" x 13	1/4"	13	9	15	37	23	100	1000
1/4" x 14	1/4"	14	9	15	37	24	10	1000
3/8" x 10	3/8"	10	8,5	19	38	22	100	1000
3/8" x 12	3/8"	12	8,5	19	38	26	100	1000
3/8" x 13	3/8"	13	8,5	19	38	22	10	1000
3/8" x 14	3/8"	14	9	17	38	30	84	672
3/8" x 15	3/8"	15	8,5	19	38	25	77	1078
3/8" x 16	3/8"	16	9,5	19	40	32	77	770
3/8" x 18	3/8"	18	11	19	40	32	54	648
3/8" x 20	3/8"	20	11	22	41	35	54	648
1/2" x 6	1/2"	6	9,5	15	38	35	100	1000
1/2" x 8	1/2"	8	9,5	15	40	36	60	600
1/2" x 10	1/2"	10	9,5	16	43	36	60	720
1/2" x 12	1/2"	12	9,5	16	43	38	60	720
1/2" x 13	1/2"	13	9,5	16	43	30	54	756
1/2" x 14	1/2"	14	9,5	18	45	35	10	480
1/2" x 15	1/2"	15	9,5	18	45	38	10	600
1/2" x 16	1/2"	16	9,5	18	44	31	112	672
1/2" x 17	1/2"	17	9,5	20	46	39	112	672
1/2" x 18	1/2"	18	9,5	20	46	40	104	624
1/2" x 20	1/2"	20	9,5	22	50	49	84	504
3/4" x 13	3/4"	13	10	22	45	49	45	630
3/4" x 14	3/4"	14	10	22	45	49	48	672
3/4" x 16	3/4"	16	10	22	48	58	42	504
3/4" x 18	3/4"	18	10	23	53	58	42	504
3/4" x 19	3/4"	19	10	23	53	53	66	528
3/4" x 20	3/4"	20	10	23	53	59	84	336
3/4" x 22	3/4"	22	10	23	48	61	66	396
3/4" x 25	3/4"	25	10	27	52,5	68	30	360
1" x 20	1"	20	13	28	55	99	45	270
1" x 25	1"	25	13	28	58	94	40	240
1" x 27	1"	27	15	34	58	115	50	300
1" x 30	1"	30	13	32	60	81	35	210
1" x 32	1"	32	14	36	63	109	10	120
1" x 35	1"	35	14	36	63	147	20	200
1.1/4" x 30	1.1/4"	30	16	38	69	120	15	150
1.1/4" x 32	1.1/4"	32	16	38	67	119	5	100
1.1/4" x 35	1.1/4"	35	16	38	67	113	15	150
1.1/4" x 38	1.1/4"	38	16	38	70	155	18	144
1.1/4" x 39	1.1/4"	39	16	38	70	156	18	144
1.1/4" x 40	1.1/4"	40	16	42	70	164	18	144
1.1/2" x 35	1.1/2"	35	16	40	70	205	15	150
1.1/2" x 38	1.1/2"	38	16	44	76	190	15	150
1.1/2" x 40	1.1/2"	40	15	44	72	179	15	150
1.1/2" x 45	1.1/2"	45	12,5	47	73	213	15	120
1.1/2" x 50	1.1/2"	50	14,5	52	75	278	8	80
1.1/2" x 51	1.1/2"	51	14,5	52	75	278	8	80
2" x 50	2"	50	14,5	52	73	236	8	80
2" x 60	2"	60	14,5	62	82	350	2	32
2.1/2" x 60	2.1/2"	60	16	65	94	533	6	48
2.1/2" x 63.5	2.1/2"	63,5	16	70	96	618	1	40
2.1/2" x 65	2.1/2"	65	16	70	96	618	5	40
2.1/2" x 70	2.1/2"	70	16	77	98	640	5	40
2.1/2" x 75	2.1/2"	75	16	77	98	663	1	40
3" x 80	3"	80	19	85	108	839	1	24
3" x 90	3"	90	19	92	110	942	1	16
4" x 100	4"	100	18	105	120	1374	1	18

**Art.245**

Portagomma femmina

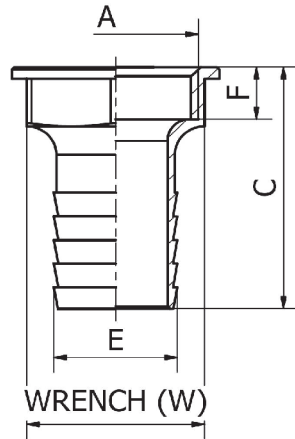
One piece female hose connector



Misura	A	E	F	W	C	gr.		
1/8" x 10	1/8"	10	11	14	32	17	100	1000
1/4" x 10	1/4"	10	11	17	35	22	10	1000
1/4" x 14	1/4"	14	11	17	35	23	10	1000
3/8" x 10	3/8"	10	11	19	36	21	125	1000
3/8" x 12	3/8"	12	11	19	36	23	84	1008
3/8" x 13	3/8"	13	10	19	36	24	84	1008
3/8" x 14	3/8"	14	10	19	36	25	125	1000
3/8" x 15	3/8"	15	10	19	36	26	88	880
1/2" x 10	1/2"	10	10	24	39	32	66	792
1/2" x 12	1/2"	12	10	24	39	30	66	792
1/2" x 13	1/2"	13	10	24	39	32	50	50
1/2" x 14	1/2"	14	10	24	38	34	40	640
1/2" x 15	1/2"	15	10	24	43	36	60	720
1/2" x 16	1/2"	16	10	24	43	44	60	720
1/2" x 18	1/2"	18	10	24	43	44	40	640
1/2" x 20	1/2"	20	10	24	44	40	40	640
3/4" x 20	3/4"	20	10	28	45	50	66	792
3/4" x 25	3/4"	25	10	29	51	57	45	450
1" x 25	1"	25	11	36	51	86	40	320
1" x 30	1"	30	11	36	57	101	32	256
1.1/4" x 30	1.1/4"	30	12	46	57	140	24	192
1.1/4" x 32	1.1/4"	32	12	46	57	144	24	192
1.1/4" x 35	1.1/4"	35	12	46	57	163	15	150
1.1/4" x 40	1.1/4"	40	12	46	63	171	5	150
1.1/2" x 38	1.1/2"	38	12	51	64	167	12	120
1.1/2" x 40	1.1/2"	40	12	51	64	170	11	110
2" x 50	2"	50	12	62	70	296	8	80

Disponibile con dado girevole Art.245/S  
Available with swivel nut Art.245/S



Misura	€
1/2"x15	3,09
3/4"x20	5,36
1"x25	5,93
1.1/4"x30	10,31
1.1/2"x40	18,80

**Art.148**

Portagomma maschio doppio

Double Male hose connector



Con guarnizione

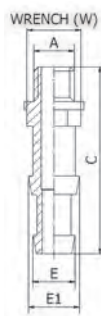

With flat gasket

Misura	A	W	E	E1	C	gr.		
1/8"x12x10	1/8"	11	10	12	46	18	30	30
3/8"x12x10	3/8"	11	10	12	46	26	30	30

**Art.205**

Portagomma curvo doppio con ghiera

Double curved hose connector

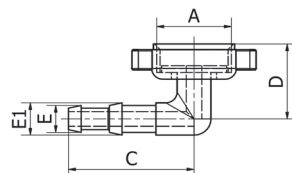

Misura	A	E	E1	C	D	gr.		
3/4" x 12 x 10	3/4"	10	12	45	28	68	15	15

**Art.180** Portagomma 3 pezzi diritto sede conica

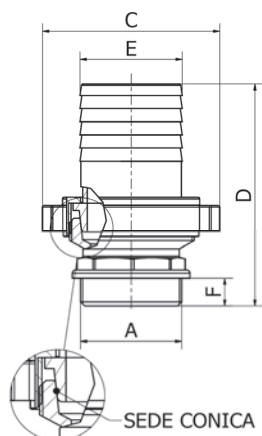
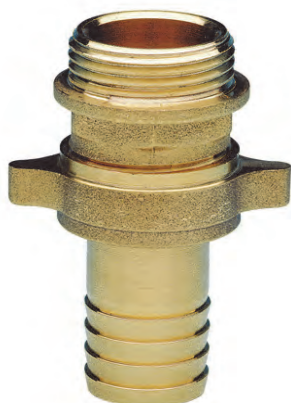
*3-pieces hose connector with conical metal seat*

Misura	A	F	E	C	D	gr.		
1/2" x 15	1/2"	10	15	37	59	74	8	360
1/2" x 18	1/2"	10	18	45	65	94	20	20
1/2" x 20	1/2"	10	20	45	64	94	20	20
3/4" x 18	3/4"	10	18	44	60	92	20	20
3/4" x 20	3/4"	10	20	44	66	94	35	210
3/4" x 25	3/4"	10	25	52	74	162	10	180
1" x 25	1"	13	25	52	78	186	54	162
1" x 30	1"	12	30	68	84	267	8	96
1.1/4" x 30	1.1/4"	12	30	68	89	259	8	96
1.1/4" x 35	1.1/4"	12	35	68	87	288	8	96
1.1/4" x 40	1.1/4"	12	40	82	93	384	1	84
1.1/2" x 40	1.1/2"	13	40	82	96	427	5	70
1.1/2" x 45	1.1/2"	13	45	98	101	583	5	70
1.1/2" x 50	1.1/2"	13	50	98	109	592	5	40
2" x 50	2"	14	50	98	110	583	4	40
2" x 60	2"	17	60	104	134	1090	1	24
2.1/2" x 60	2.1/2"	17	60	104	133	1107	1	24

**Art.200** Portagomma 3 pezzi curvo sede conica

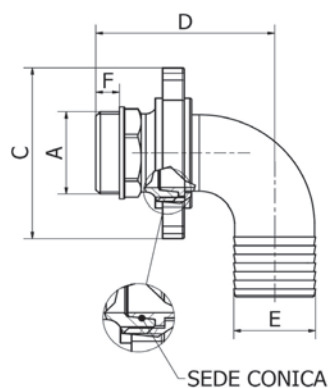
*3-pieces hose connector with conical metal seat*

Misura	A	F	E	C	D	gr.		
1/2" x 15	1/2"	10	15	37	57	98	20	20
1/2" x 18	1/2"	10	18	45	60	126	20	20
1/2" x 20	1/2"	10	20	45	63	141	20	20
3/4" x 20	3/4"	10	20	44	64	141	10	160
3/4" x 25	3/4"	10	25	52	71	207	10	132
1" x 25	1"	13	25	52	75	245	9	108
1" x 30	1"	12	30	68	79	375	72	360
1.1/4" x 30	1.1/4"	12	30	68		367	10	72
1.1/4" x 35	1.1/4"	12	35	68		392	10	10
1.1/4" x 40	1.1/4"	12	40	82		549	10	10
1.1/2" x 40	1.1/2"	13	40	82	89	545	5	48
1.1/2" x 45	1.1/2"	13	45	98		756	5	42
2" x 50	2"	14	50	98	99	888	5	24
2" x 60	2"	17	60	104	130	1510	5	5
2.1/2" x 60	2.1/2"	17	60	104	130	1543	4	4

**Art.185** Attacco per raccordi sede metallo

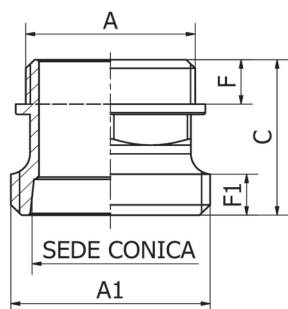
*Attack for metal seat hose connector*

Misura	A	A1	F	F1	C	gr.		
1/2" x 15	1/2"	1/2"	10	7	30	35	10	10
3/4" x 20	3/4"	3/4"	11	8	33	49	10	10
3/4" x 25	3/4"	1"	10	8	34	60	10	10
1" x 25	1"	1"	13	9	37	90	10	10
1" x 30	1"	1.1/4"	12	9	36	118	10	10
1.1/4" x 30	1.1/4"	1.1/4"	13	11	35	116	5	5
1.1/4" x 40	1.1/4"	1.1/2"	12	11	37	122	5	5
1.1/2" x 40	1.1/2"	1.1/2"	13	15	37	158	5	5
1.1/2" x 45	1.1/2"	ø 56	13	12	45	202	5	5
1.1/2" x 50	1.1/2"	2"	14	11	44	197	1	1
2" x 50	2"	2"	14	11	44	197	1	1
2" x 60	2"	2.1/2"	18	15	54	444	1	1
2.1/2" x 60	2.1/2"	2.1/2"	18	14	53	477	1	1

Per Art.180 e Art.200

**Art.190**

Portagomma diritto sede conica c/ghiera

*Straight hose connector conical seat with locking ring*

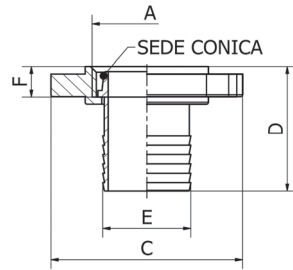

Misura	A	E	F	C	D	gr.		
1/2" x 15	1/2"	15	7	37	35	40	10	10
3/4" x 18	3/4"	18	8	44	34	43	10	10
3/4" x 20	3/4"	20	8	44	40	57	10	10
1" x 25	1"	25	8	52	48	93	10	10
1.1/4" x 30	1.1/4"	30	11	68	60	153	5	5
1.1/4" x 35	1.1/4"	35	11	68	63	183	5	5
1.1/2" x 40	1.1/2"	40	13	82	68	231	5	5
ø56 x 45	ø56	45	14	98	67	376	1	1
2" x 50	2"	50	14	98	78	395	1	1
2" x 60	2"	60	21	104	94	646	1	1
2.1/2" x 60	2.1/2"	60	21	104	94	660	1	1

**Art.191**

Portagomma diritto sede piana c/ghiera

*Straight hose connector flat seat with locking ring*

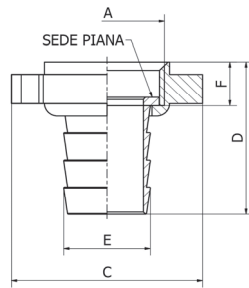

Misura	A	E	F	C	D	gr.		
1/2" x 15	1/2"	16	8,5	37	44	40	10	10
3/4" x 12 x10	3/4"	12	11	44	44	48	10	10
3/4" x 15	3/4"	15	11	44	39	45	10	10
3/4" x 20	3/4"	20	11	44	39	42	10	10
1" x 25	1"	25	12	52	52	83	10	10
1.1/4" x 30	1.1/4"	30	14	68	63	132	5	5
1.1/4" x 35	1.1/4"	35	14	68	67	164	5	5
1.1/2" x 40	1.1/2"	40	15	82	70	192	1	1
2" x 50	2"	50	16	98	82	338	1	1

**Art.195**

Portagomma curvo sede conica c/ghiera

*Curved hose connector conical seat with locking ring*

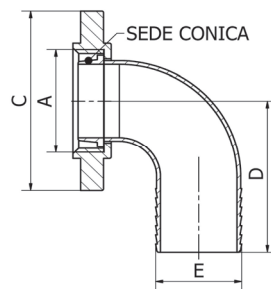

Misura	A	E	F	C	gr.		
3/4" x 15	3/4"	15	11	44	55	10	10
3/4" x 20	3/4"	20	11	44	91	10	10
1" x 25	1"	25	12	52	158	10	10
1.1/4" x 30	1.1/4"	30	14	68	258	5	5
1.1/4" x 35	1.1/4"	35	14	68	283	5	5
1.1/2" x 40	1.1/2"	40	15	82	395	5	5
ø56 x 45	ø56	45	14	98	551	1	1
2" x 50	2"	50	16	98	575	1	1

**Art.197**

Portagomma curvo sede piana c/ghiera

*Curved hose connector flat seat with locking ring*

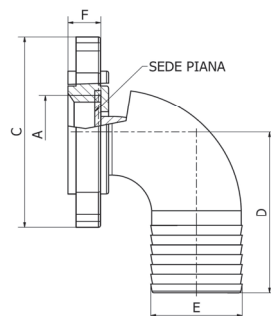

Misura	A	E	F	C	gr.		
3/4" x 20	3/4"	20	11	44	83	10	10
1" x 25	1"	25	12	52	129	10	10
1.1/4" x 30	1.1/4"	30	14	68	230	5	5
1.1/4" x 35	1.1/4"	35	14	68	245	5	5
1.1/2" x 40	1.1/2"	40	15	82	405	1	1
2" x 50	2"	50	16	98	524	1	1

**Art.240**

Giunto portagomma 3 pz.

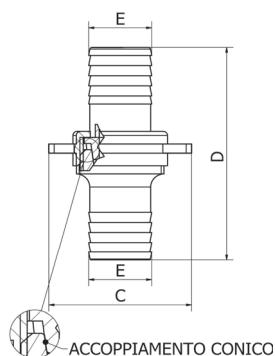
*Joint hose connector 3 pcs.*

Misura	E	D	C	gr.		
MM 15	15	15	36	59	20	20
MM 20	20	20	44	92	20	20
MM 25	25	25	52	152	20	20
MM 30	30	30	68	258	10	10
MM 35	35	35	76	315	10	10
MM 40	40	40	82	369	5	5
MM 45	45	45	99	595	5	5
MM 50	50	50	98	645	5	5

**Art.658**

Raccordo per contatori

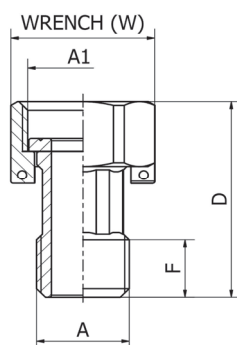
*Water meter connector*

Misura	A	A1	F	W	D	gr.		
1/2" x 3/4"	1/2"	3/4"	14	29	45	69	35	35
3/4" x 1"	3/4"	1"	15	36	56	118	30	30
1" x 1.1/4"	1"	1.1/4"	16	46	59	210	25	25
1.1/4" x 1.1/2"	1.1/4"	1.1/2"	20	53	71	306	20	20
1.1/2" x 2"	1.1/2"	2"	23	66	80	485	15	15
2" x 2.1/2"	2"	2.1/2"	27	83	93	890	10	10

**CON GUARNIZIONE INCLUSA**  
**WITH GASKET INCLUDED**
**Art.261**

Dado + codolo con OR

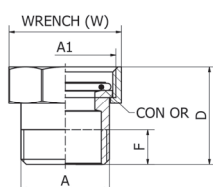
*Nut + tang with O-ring*

Misura	A	A1	F	W	D	gr.		
1/2" x 3/4"	1/2"	3/4"	11	30	33	65	45	45
3/4" x 1"	3/4"	1"	10	37	38	77	28	28
1" x 1.1/4"	1"	1.1/4"	15	46	44	150	20	20

 Disponibile anche nichelato (Art.261/N)  
 Available also nickel plated (Art.261/N)

**Art.262**

Dado + codolo sede piana

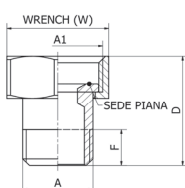
*Nut + tang with flat seat*

Misura	A	A1	F	W	D	gr.		
1/2" x 3/4"	1/2"	3/4"	11	30	33	62	70	70
3/4" x 1"	3/4"	1"	10	37	38	74	28	28
1" x 1.1/4"	1"	1.1/4"	15	46	44	127	20	20
1.1/4" x 1.1/2"	1.1/4"	1.1/2"	16	53	50	242	10	10
1.1/2" x 2"	1.1/2"	2"	20	64	52	322	4	4
2" x 2.1/2"	2"	2.1/2"	19	82	73	729	2	2

 Disponibile anche nichelato (Art.262/N)  
 Available also nickel plated (Art.262/N)

**Art.260**

Raccordo diritto 3 pezzi M.F.

3-pieces straight connector M.F.

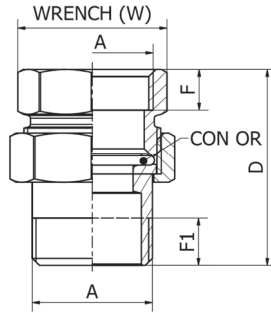

Disponibile anche nichelato (Art.260/N)  
Available also nickel plated (Art.260/N)

Misura	A	F	F1	W	D	gr.		
1/4"	1/4"	11	12	17	37,5	45	10	10
3/8"	3/8"	8	8	23	42	80	10	10
1/2"	1/2"	10	11	25	45	96	10	280
3/4"	3/4"	10	10	30	54	115	28	168
1"	1"	11	15	37	60	212	20	80
1.1/4"	1.1/4"	15	16	48	69	376	10	60
1.1/2"	1.1/2"	16,5	20	55	73	541	6	48
2"	2"	18,5	20	66	98	654	2	40
2.1/2"	2.1/2"	20,5	27	83	103	1320	1	24
3"	3"	23	23	96	116		1	10
4"	4"							

A RICHIESTA / ON REQUEST

**Art.263**

Raccordo diritto F.F. 3 pezzi

3-pieces straight connector F.F.

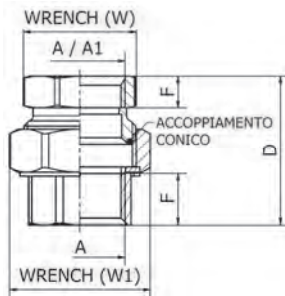

CON SEDE O-RING  
WITH O-RING SEAT

Misura	A / A1	W	W1	D	gr.		
1/2"	1/2"	25	37	41	139	10	10
3/4"	3/4"	30	47	45	209	10	10
1"	1"	38	53	57	341	10	10
1.1/4"	1.1/4"	46	64	57	437	10	10
1.1/2"	1.1/2"	54	72	57	596	5	5
2"	2"	66	87	69	1035	5	5

**Art.263/OR**

Misura	A	A1	W	W1	D	gr.		
1"	1"	1"	37	53	57	295	10	10
1.1/4" x 1"	1"	1.1/4"	38	53	58	331	10	10

**Art.265**

Raccordo curvo 3 pezzi M.F.

3-pieces curved connector M.F.

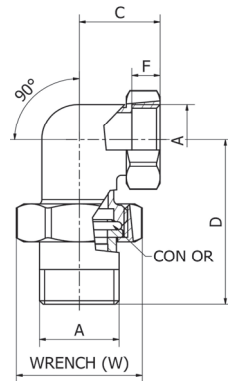

Misura	A	F	W	C	D	gr.		
3/8"	3/8"	9	27	19	47	92	20	200
1/2"	1/2"	9,5	37	20	52	119	21	210
3/4"	3/4"	12	46	26	61	196	18	144
1"	1"	12	53	35	72	318	15	60
1.1/4"	1.1/4"	20	64	42	85	525	8	48
1.1/2"	1.1/2"	18,5	64	40	89	796	2	2
2"	2"	20	80	70	118	1554	2	2

Disponibile anche nichelato (Art.265/N)  
Available also nickel plated (Art.265/N)

**Art.266**

Raccordo 3 pz. M/M sede OR

3 pcs connector M/M, OR seat

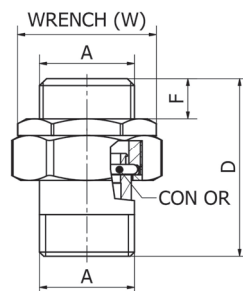

Misura	A	F	W	D	gr.		
3/8"	3/8"	10	27	52	85	20	20
1/2"	1/2"	11,5	27	56	116	20	20
3/4"	3/4"	12	34	62	180	20	20
1"	1"	15	42	69	297	20	100
1.1/4"	1.1/4"	10	53	79	412	10	10

Misura	A	A1	gr.		
1.1/4" x 1"	1"	1.1/4"	410	10	10

Disponibile anche nichelato (Art.266/N)  
Available also nickel plated (Art.266/N)

**Art.269** Ghiera

*Nut*

Disponibile anche nichelato (Art.269/N)  
 Available also nickel plated (Art.269/N)

Misura		
1/2"	10	100
3/4"	10	100
1"	10	100
1.1/4"	10	50
1.1/2"	10	40
2"	10	30
2.1/4"	5	10
2.1/2"	5	10
2.3/4"	5	10
3"	5	10

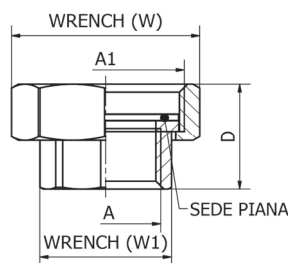
**Art.264** Raccordo 2 pezzi per pompe e circolatori *2-pieces connector F.F. flat seat*

Misura	A	A1	W	W1	D	gr.		
1/2" x 1"	1/2"	1"	37	26	26	90	20	20
3/4" x 1.1/4"	3/4"	1.1/4"	46	31	30	146	20	20
1/2" x 1.1/2"	1/2"	1.1/2"	54	26	36	219	20	20
3/4" x 1.1/2"	3/4"	1.1/2"	54	32	36	233	20	20
1" x 1.1/2"	1"	1.1/2"	52	38	34	200	10	10
1.1/4" x 2"	1.1/4"	2"	64	47	39	286	10	10
1.1/2" x Ø22	1.1/4"	Ø22	52	ø26	32	125	10	10

→ DN22 a saldare / welding

Sede piana con guarnizione

*Flat seat with gasket*

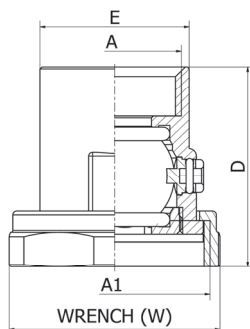
**Art.267** Raccordo a sfera per pompe e circolatori *Ball connector F.F. for pumps*

Misura	A	A1	W	E	D	gr.		
1.1/2" x 3/4"	3/4"	1.1/2"	53	36	52	257	14	14
1.1/2" x 1"	1"	1.1/2"	52	37	52	275	8	112
2" x 1.1/4"	1.1/4"	2"	65	47	69	520	12	48

Sede piana con guarnizione

*Flat seat with gasket*



**Art.270**

Raccordo diretto per cassone

*Straight tank connector*

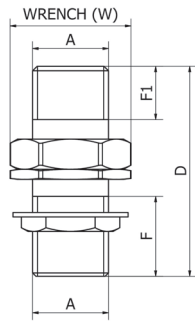

Misura	A	F	F1	W	D	gr.		
3/8"	3/8"	35	12	23	67	80	20	20
1/2"	1/2"	23,5	46	31	83	140	30	240
3/4"	3/4"	22	41	37	93	221	15	120
1"	1"	24	41	46	95	316	12	48
1.1/4"	1.1/4"	28	39	53	94	414	4	40
1.1/2"	1.1/2"	28	43	58	102	550	5	30
2"	2"	33	45	69	114	798	1	30

Con guarnizione tra le parti

*With flat gasket between parts*

**Art.275**

Raccordo curvo per cassone

*Elbow tank connector*

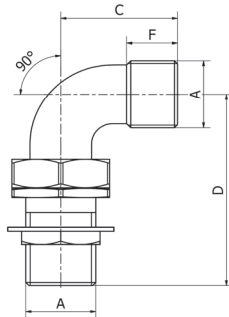

Misura	A	F	W	C	D	gr.		
1/2"	1/2"	24	30	40	86	179	10	10
3/4"	3/4"	19	38	56	91	267	10	10
1"	1"	25	49	61	94	390	10	10

Con guarnizione tra le parti

*With flat gasket between parts*

**Art.278**

Raccordo cassone con tappo

*Tank connector with blind*

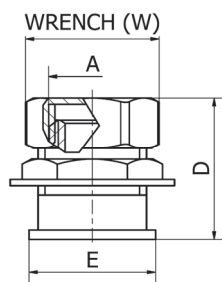

Misura	A	W	E	D	gr.		
1/2"	1/2"	24	35	52	90	90	270
3/4"	3/4"	31	41	59	155	50	150
1"	1"	34	49	56	193	45	135
1.1/4"	1.1/4"	46,5	56	64	312	5	90
1.1/2"	1.1/2"	53	63	57	465	25	25
2"	2"	65	72	54	604	10	30

**Art. 278/F Raccordo cassone filettato internamente con tappo**  
*Connector for tank with blind and inner threading*

Misura	A	A1		
1/2"x3/8"	1/2"	3/8"	20	160
3/4"x1/2"	3/4"	1/2"	15	120
1"x3/4"	1"	3/4"	10	80

**Art.277**

Raccordo cassone senza tappo

*Tank connector*

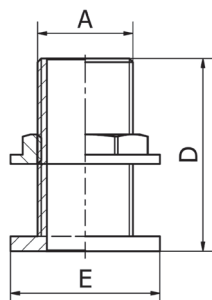

Misura	A	E	D	gr.		
1/2"	1/2"	35	48	85	20	300
3/4"	3/4"	41	53	129	15	180
1"	1"	49	54	186	24	96
1.1/4"	1.1/4"	56	58	216	15	60
1.1/2"	1.1/2"	63	54	324	4	48
2"	2"	72	52	408	4	32

**Art. 277/F Raccordo cassone filettato internamente, senza tappo**  
*Connector for tank without blind with inner threading*

Misura	A	A1		
1/2"x3/8"	1/2"	3/8"	20	160
3/4"x1/2"	3/4"	1/2"	15	120
1"x3/4"	1"	3/4"	10	80

**Art.271**

Racc. diritto per cassone con portagom.

*Straight tank connector with hose connector*

Con guarnizione

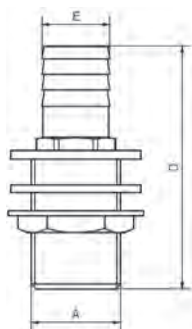
*With flat gasket*

Misura	A	E	C	gr.		
1"	1"	25	93,5	221	15	120

**Art.272**

Raccordo curvo cassone con portagom.

*Elbow tank connector with hose connector*

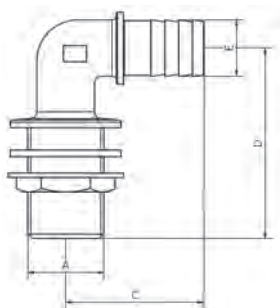

Con guarnizione

*With flat gasket*

Misura	A	E	C	D	gr.		
1"	1"	25	60	86	291	10	80

**Art.276**

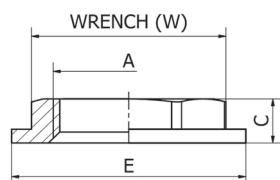
Rosetta

*Washer*

Misura	A	W	E	C	gr.		
3/8"	3/8"	20	30	7	12	50	50
1/2"	1/2"	25	35	7	22	100	1000
3/4"	3/4"	30	41	8	30	100	1000
1"	1"	37	50	9	37	72	720
1.1/4"	1.1/4"	45	60	9	50	72	432
1.1/2"	1.1/2"	52	67	10	65	54	324
2"	2"	65,5	83	11	118	36	216

**Art.590/R**

Raccordo a "T" F.F.F. ridotto

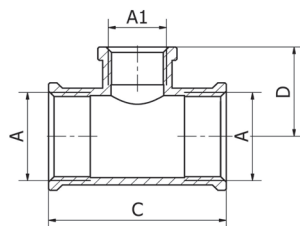
*Reduced tee F.F.F.*

Misura	A	A1	C	D	gr.		
1/2"x3/8"	1/2"	3/8"				10	10
3/4"x 1/2"	3/4"	1/2"	52	47	129	10	10
1" x 1/2"	1"	1/2"	67	55	194	5	5
1" x 3/4"	1"	3/4"	67	55	198	5	5
1.1/4"X1/2"	1.1/4"	1/2"				5	5
1.1/4"X3/4"	1.1/4"	3/4"				5	5
1.1/4"X1"	1.1/4"	1"				5	5
1.1/2"X1/2"	1.1/2"	1/2"				5	5
1.1/2"X3/4"	1.1/2"	3/4"				5	5
1.1/2"X1"	1.1/2"	1"				5	5
1.1/2"X1.1/4"	1.1/2"	1.1/4"				5	5
2"x1/2"	2"	1/2"				5	5
2"x3/4"	2"	3/4"				5	5
2"x1"	2"	1"				5	5
2"x11/4"	2"	1.1/4"				5	5

**Art.590/M** Raccordo a "T" M.M.M.

*Tee M.M.M.*

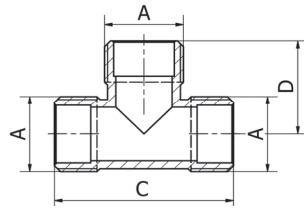

Misura	A	C	D	gr.		
3/8"	3/8"	40	30	57	10	10
1/2"	1/2"	55	38	63	10	10
3/4"	3/4"	52	26	88	10	10
1"	1"	78	56	180	10	10

**Art.590** Raccordo a "T" F.F.F.

*Tee F.F.F.*

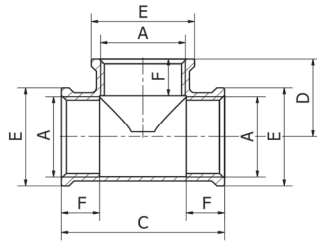

Misura	A	F	E	C	D	gr.		
1/8"	1/8"	11	17	34	17	37	56	560
1/4"	1/4"	10	19	38	20	39	50	500
3/8"	3/8"	12	20	43	21	58	32	384
1/2"	1/2"	14	28	48	24	79	36	288
3/4"	3/4"	16	33	50	30	94	45	180
1"	1"	18	41	70	35	167	16	128
1.1/4"	1.1/4"	18	50	84	42	310	8	80
1.1/2"	1.1/2"	20	58	96	48	472	1	48
2"	2"	25	65	115	58	769	3	27
2.1/2"	2.1/2"	27,5	86	132	68	1207	1	13
3"	3"	30	99	150	75	1675	1	8
4"	4"	34	123	182	91	2379	1	5

Disponibile anche nichelato (Art.590/N)  
Available also nickel plated (Art.590/N)

**Art.591** Raccordo a "T" F.F.F. cromato

*Chromium plated tee F.F.F.*

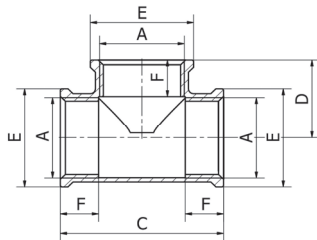

Misura	A	E	F	W	C	gr.		
1/4"	1/4"	10	19	38	20	39	50	500
3/8"	3/8"	12	20	43	21	58	32	256
1/2"	1/2"	14	28	48	24	79	36	288
3/4"	3/4"	16	33	60	30	106	10	180
1"	1"	18	41	70	35	167	12	108

**Art.592** Raccordo a croce F.F.F.F.

*Cross F.F.F.F.*

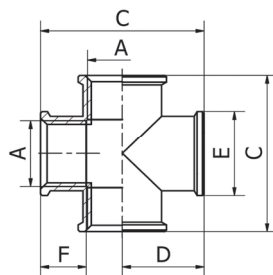

Misura	A	F	E	C	D	gr.		
1/2"	1/2"	14	27	50	25	97	5	160
3/4"	3/4"	14	33	60	30	151	20	80
1"	1"	14,5	41	61	31	208	18	72
1.1/4"	1.1/4"	19	49	81	41	401	5	5
1.1/2"	1.1/2"	20,5	57	95	48	518	5	5
2"	2"	26,5	70	115	58	751	2	2

**Art.595** Raccordo a 90° F.F.

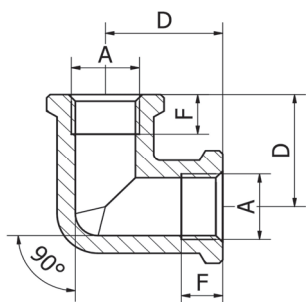
*Elbow 90° F.F.*

Misura	A	F	D	gr.		
1/8"	1/8"	10	18	28	120	960
1/4"	1/4"	11	20	30	180	1080
3/8"	3/8"	13	23	53	30	600
1/2"	1/2"	14	27	67	50	300
3/4"	3/4"	14	30	102	16	224
1"	1"	14,5	32	160	20	160
1.1/4"	1.1/4"	17	44	310	6	72
1.1/2"	1.1/2"	20	46	383	6	72
2"	2"	22	55	541	4	36
2.1/2"	2.1/2"	29	68	1038	1	16
3"	3"	29	75	1287	1	12
4"	4"	33	92	2091	1	5

**Art.594** Raccordo a 90° F.F. ridotto

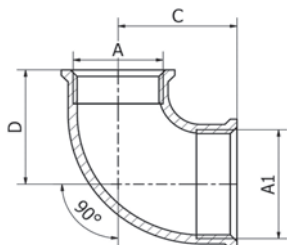
*Reduced elbow 90° F.F.*

Misura	A	A1	C	D	gr.		
1/2" x 3/4"	1/2"	3/4"	30	30	122	12	10
1/2" x 1"	1/2"	1"	32	32	187	10	10
3/4" x 1"	3/4"	1"	32	32	158	10	10
1" x 1.1/4"	1"	1.1/4"	44	44	232	15	90
1" x 1.1/2"	1"	1.1/2"			10	10	
1.1/4" x 1.1/2"	1.1/4"	1.1/2"			10	10	

**Art.596** Raccordo a 90° F.F. cromato

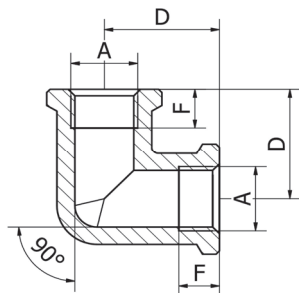
*Chromium plated elbow 90° F.F.*

Misura	A	F	D	gr.		
1/4"	1/4"	11	20	30	10	50
3/8"	3/8"	13	23	53	10	600
1/2"	1/2"	14	27	63	50	300
3/4"	3/4"	14	30	102	20	200
1"	1"	14,5	32	160	20	160

**Art.597** Raccordo a 90° F.F. nichelato

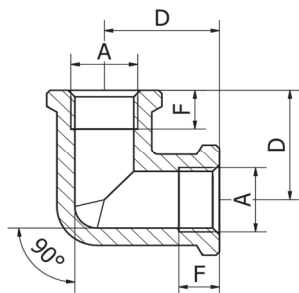
*Nickel plated elbow 90° F.F.*

Misura	A	F	D	gr.		
1"	1"	14,5	32	160	20	160

Altre misure su richiesta  
Other sizes on request

**Art.593**

Raccordo a 45° F.F.

*Elbow 45° F.F.*



Misura	A		
3/8"	3/8"	10	10
1/2"	1/2"	10	10
3/4"	3/4"	10	10
1"	1"	10	10
1.1/4"	1.1/4"	5	5
1.1/2"	1.1/2"	5	5
2"	2"	5	5
2.1/2"	2.1/2"	5	5
3"	3"	5	5

**Art.600**

Raccordo a 90° M.F.

*Elbow 90° M.F.*

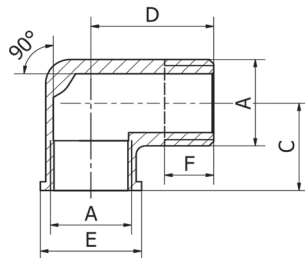

Misura	A	F	E	C	D	gr.		
1/8"	1/8"	11	17	14	21	20	10	100
1/4"	1/4"	9	19	18	28	37	56	672
3/8"	3/8"	10	20	20	34	46	10	400
1/2"	1/2"	13	28	26	33	77	70	280
3/4"	3/4"	15	33	30	40	120	35	140
1"	1"	15	41	32	49	174	9	126
1.1/4"	1.1/4"	18	50	41	58	320	10	80
1.1/2"	1.1/2"	21	58	46	64	411	6	54
2"	2"	22	65	55	69	620	4	36
2.1/2"	2.1/2"	25,5	87	68	80	1117	1	1
3"	3"	29	100	77	89	1457	1	1
4"	4"						1	1

**Art.601**

Raccordo a 90° M.F. cromato

*Chromium plated elbow 90° M.F.*

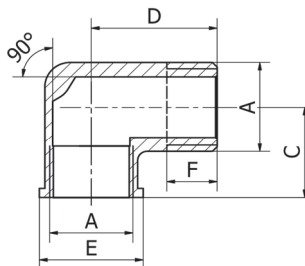

Misura	A	F	E	C	D	gr.		
1/4"	1/4"	9	19	18	28	37	56	672
3/8"	3/8"	10	20	20	34	46	90	540
1/2"	1/2"	13	28	33	26	75	40	320
3/4"	3/4"	15	33	30	40	120	14	224
1"	1"	15	41	32	49	175	16	128

**Art.602**

Raccordo a 90° M.F. nichelato

*Nickel plated elbow 90° M.F.*

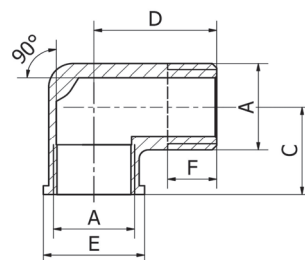

Misura	A	F	E	C	D	gr.		
3/8"	3/8"	10	20	20	34	46	100	400
1/2"	1/2"	13	28	33	26	75	40	320
3/4"	3/4"	15	33	30	40	120	14	224
1"	1"	15	41	32	49	175	9	126

Altre misure su richiesta  
*Other sizes on request*

**Art.603** Raccordo a 90° M.M.

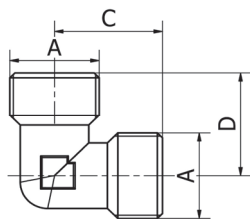
*Elbow 90° M.M.*

Misura	A	C	D	gr.		
3/8"	3/8"	24	24	40	10	10
1/2"	1/2"	26,5	27	48	10	10
3/4"	3/4"	31,5	32	81	10	10
1"	1"	40	40	152	24	144

**Art.604** Raccordo a 45° M.F.

*Elbow 45° M.F.*



Misura	A		
3/8"	3/8"	10	10
1/2"	1/2"	10	10
3/4"	3/4"	10	10
1"	1"	10	10
1.1/4"	1.1/4"	5	5
1.1/2"	1.1/2"	5	5
2"	2"	5	5
2.1/2"	2.1/2"	5	5
3"	3"	5	5

**Art.600/R** Raccordo a 90° M.F. ridotto

*Reduced elbow 90° M.F.*

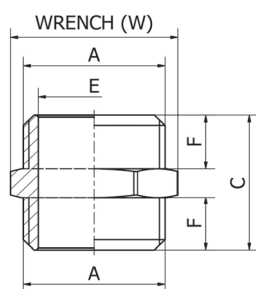

Misura	AM	AF		
1/2"x3/4"	1/2"	3/4"	10	10
1/2"x1"	1/2"	1"	10	10
3/4"x1"	3/4"	1"	10	10

**Art.605** Niplo

*Nipple*

Misura	A	F	W	E	C	gr.		
1/8"	1/8"	7	10	5,5	18	7	100	100
1/4"	1/4"	9	15	8,5	22	14	40	1000
3/8"	3/8"	10,5	17	12	26	20	50	500
1/2"	1/2"	11	21	15	26	27	10	800
3/4"	3/4"	12	27	20	30	49	10	400
1"	1"	13	34	27	33	80	10	240
1.1/4"	1.1/4"	14	43	35	35	108	4	144
1.1/2"	1.1/2"	16	48	41	39	139	24	144
2"	2"	18	60	51	43	231	15	60
2.1/2"	2.1/2"	27	76	63	68	664	1	30
3"	3"	30	89	74	75	1009	1	22
4"	4"	36	115	98	90	1672	1	5

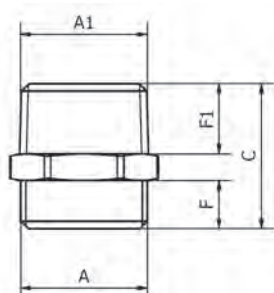
**Art.605/S** Niplo Adattatore GAS/NPT

*Nipple Adapter GAS/NPT*

Misura	A	F	A1	F1	C	gr.		
3/4"	3/4"G	12,5	3/4"N	15	33,5	60	10	60
1"	1"G	13	1"N	19	39	105	10	50

**GAS / NPT**

**Art.606**

Niplo cromato

*Chromium plated nipple*

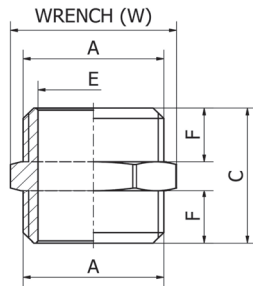

Misura	R	F	W	E	C	gr.		
1/4"	1/4"	9	15	8,5	22	14	10	2000
3/8"	3/8"	10	18	12	26	20	10	500
1/2"	1/2"	11	21	15	26	27	10	800
3/4"	3/4"	12	27	19	30	49	10	400
1"	1"	13	34	27	33	80	10	240
1.1/4"	1.1/4"	16	42	34	39	108	4	144

Altre misure su richiesta  
*Other sizes on request*

**Art.607**

Niplo Pesante, filetto CONICO

*Heavy nipple, CONIC thread*

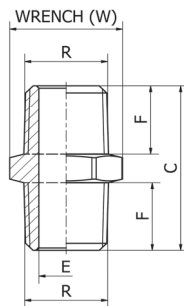
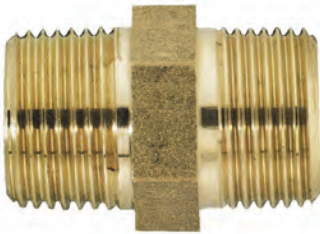

Misura	R	F	W	E	C	gr.		
3/8"	3/8"	14,5	20	11	35	37	120	720
1/2"	1/2"	15,5	25	15	38	54	10	600
3/4"	3/4"	16	29	20	39	78	50	300
1"	1"	19	38	26	46	132	14	196
1.1/4"	1.1/4"	22,5	47	35	54	205	4	120
1.1/2"	1.1/2"	23	55	39	55	295	6	72
2"	2"	24	65	50	57	386	6	60

**Art.608**

Riduzione filetto GAS / NPT

*GAS / NPT reduced nipple*



**GAS / NPT**

Misura		
1/2" GAS (F) / NPT(M)	5	5
3/4" GAS (F) / NPT(M)	5	5
3/4" NPT(F) / GAS (M)	5	5
1" GAS (F) / NPT(M)	5	5
1" NPT(F) / GAS (M)	5	5
1.1/4" GAS (F) / NPT(M)	5	5
1.1/4" NPT(F) / GAS (M)	5	5
1.1/2" GAS (F) / NPT(M)	1	1
1.1/2" NPT(F) / GAS (M)	1	1
2" NPT(F) / GAS (M)	1	1
2.1/2" NPT(F) / GAS (M)	1	1

**Art.632**

Niplo ridotto M.F.

*Bushing reduced nipple M.F.*



Misura		
1/2"x3/8"	10	10
3/4"x1/2"	10	10
1"x3/4"	10	10

**Art.609**

Niplo per alimentatori

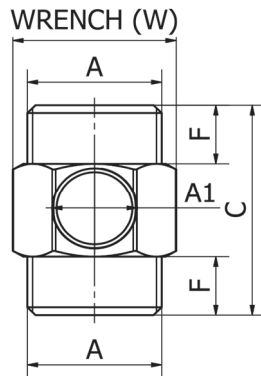
*Water supply nipple*

Misura	A	A1	F	W	C	gr.		
1" x 1/4"	1"	1/4"	14	35	49	158	48	192
1" x 1/2"	1"	1/2"	14	35	54	167	32	160
1.1/4" x 1/4"	1.1/4"	1/4"	17	43	53	237	12	96
1.1/4" x 1/2"	1.1/4"	1/2"	17	43	62	276	15	90
1.1/2" x 1/4"	1.1/2"	1/4"	18	50	62	376	8	80
1.1/2" x 1/2"	1.1/2"	1/2"	18	50	62	357	8	80
2" x 1/4"	2"	1/4"	18	61	62	494	6	48
2" x 1/2"	2"	1/2"	18	61	62	513	6	48

**Art.609/D CON DOPPIO FORO / WITH DOUBLE HOLE**

Misura	A	A1	F	W	C	gr.		
1" x 1/4"X1/4"	1"	1/4"	14	35	49	158	48	192

**Art.610**

Niplo ridotto

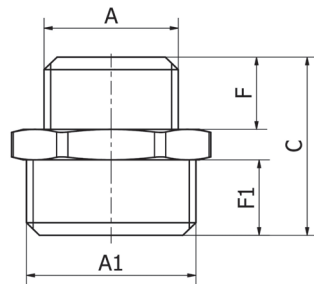
*Reduced nipple*

Misura	A	A1	F	F1	C	gr.		
1/4" x 1/8"	1/8"	1/4"	8	9	22	14	10	10
3/8" x 1/4"	1/4"	3/8"	8,5	9	22	16	10	100
1/2" x 1/4"	1/4"	1/2"	11	11	27	27	10	10
1/2" x 3/8"	3/8"	1/2"	11	12	27	27	10	500
3/4" x 3/8"	3/8"	3/4"	11	12	28	47	10	200
3/4" x 1/2"	1/2"	3/4"	12	12	29	48	10	560
1" x 1/2"	1/2"	1"	12	14	32	73	10	240
1" x 3/4"	3/4"	1"	14	14	35	72	10	320
1.1/4" x 1/2"	1/2"	1.1/4"	12	14	32	125	10	10
1.1/4" x 3/4"	3/4"	1.1/4"	13	14	34	131	25	25
1.1/4" x 1"	1"	1.1/4"	18	19	44	144	18	144
1.1/2" x 3/4"	3/4"	1.1/2"	12	17	35	162	10	10
1.1/2" x 1"	1"	1.1/2"	15	17	39	161	5	120
1.1/2" x 1.1/4"	1.1/4"	1.1/2"	17	15	40	157	15	120
2" x 1"	1"	2"	15	18	42	259	10	10
2" x 1.1/4"	1.1/4"	2"	18	17	43	238	1	10
2" x 1.1/2"	1.1/2"	2"	17	18	43	311	6	60
2.1/2" x 2"	2"	2.1/2"	22	27	63	624	1	1
3" x 2"	2"	3"	22	19	52	610	1	1
3" x 2.1/2"	2.1/2"	3"	22	19	52	662	1	1

**Art.611**

Niplo ridotto cromato

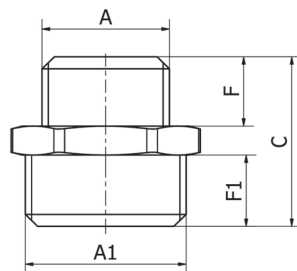
*Chromium plated reduced nipple*

Misura	A	A1	F	F1	C	gr.		
1/4" x 1/8"	1/8"	1/4"	8	9	22	14	10	1500
3/8" x 1/4"	1/4"	3/8"	8,5	9	22	16	10	1500
1/2" x 1/4"	1/4"	1/2"	11	11	27	27	10	500
1/2" x 3/8"	3/8"	1/2"	11	12	27	27	10	500
3/4" x 3/8"	3/8"	3/4"	11	12	28	47	10	200
3/4" x 1/2"	1/2"	3/4"	12	12	29	43	60	600
1" x 1/2"	1/2"	1"	12	14	32	73	10	300
1" x 3/4"	3/4"	1"	14	14	35	72	50	300

 Altre misure su richiesta  
*Other sizes on request*



**Art.612**

**Niplo ridotto Pesante, filetto CONICO**

*Heavy reduced nipple, CONIC thread*

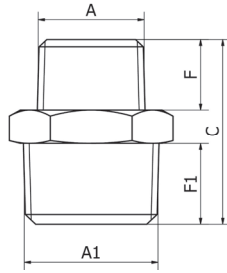

Misura	A	A1	F	F1	C	gr.		
1/2" x 3/8"	3/8"	1/2"	13	15	36	53	80	640
3/4" x 1/2"	1/2"	3/4"	15	17	38	66	28	392
1" x 1/2"	1/2"	1"	17	21	45	125	28	168
1" x 3/4"	3/4"	1"	17	21	44	126	30	180

**Art.615**

**Riduzione esagonale M.F.**

*Bushing M.F.*

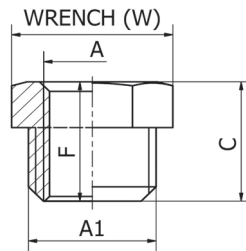

Misura	A	A1	F	W	C	gr.		
1/4" x 1/8"	1/8"	1/4"	14	14	14	7	10	1800
3/8" x 1/8"	1/8"	3/8"	6	17	14	14	10	1000
3/8" x 1/4"	1/4"	3/8"	14	17	14	10	10	400
1/2" x 1/8"	1/8"	1/2"	7,5	22	17	30	10	100
1/2" x 1/4"	1/4"	1/2"	7	21	17	23	10	960
1/2" x 3/8"	3/8"	1/2"	17	21	17	18	10	500
3/4" x 1/4"	1/4"	3/4"	18	21	18	38	80	480
3/4" x 3/8"	3/8"	3/4"	9,5	27	19	46	10	500
3/4" x 1/2"	1/2"	3/4"	18	27	18	32	10	800
1" x 3/8"	3/8"	1"	11	33	20	86	10	400
1" x 1/2"	1/2"	1"	13	34	23	77	10	400
1" x 3/4"	3/4"	1"	14	34	22	55	10	400
1.1/4" x 1/2"	1/2"	1.1/4"	13	42	24	154	16	144
1.1/4" x 3/4"	3/4"	1.1/4"	13	43	23	131	16	144
1.1/4" x 1"	1"	1.1/4"	23	42	23	96	60	240
1.1/2" x 3/8"	3/8"	1.1/2"	10	50	24	230	40	160
1.1/2" x 1/2"	1/2"	1.1/2"	10	48	24	220	10	190
1.1/2" x 3/4"	3/4"	1.1/2"	11	49	24	200	4	160
1.1/2" x 1"	1"	1.1/2"	14	49	24	170	12	120
1.1/2" x 1.1/4"	1.1/4"	1.1/2"	26	48	26	95	10	160
2" x 1/2"	1/2"	2"	11	60	27	408	18	72
2" x 3/4"	3/4"	2"	12	60	26	389	10	90
2" x 1"	1"	2"	14	60	26	351	5	100
2" x 1.1/4"	1.1/4"	2"	15	60	28	223	25	100
2" x 1.1/2"	1.1/2"	2"	17	60	26	225	24	96
2.1/2" x 2"	2"	2.1/2"	24	77	35	519	5	10
3" x 1.1/4"	1.1/4"	3"	22	89	3	970	5	5
3" x 1.1/2"	1.1/2"	3"	22	89	35	965	5	5
3" x 2"	2"	3"	19	89	44	911	5	5
3" x 2.1/2"	2.1/2"	3"	44	89	44	618	5	5
4" x 3"	3"	4"	25	135	51	1439	5	5

**Art.616**

**Riduzione esagonale M.F. cromata**

*Chromium plated bushing M.F.*

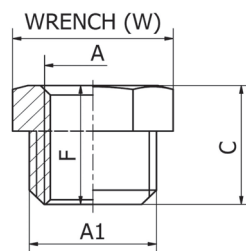

Misura	A	A1	F	W	C	gr.		
1/4" x 1/8"	1/8"	1/4"	14	14	14	7	50	150
3/8" x 1/8"	1/8"	3/8"	6	17	14	14	10	100
3/8" x 1/4"	1/4"	3/8"	14	17	14	10	100	100
1/2" x 1/8"	1/8"	1/2"	7,5	22	17	30	100	100
1/2" x 1/4"	1/4"	1/2"	8	21	17	23	120	120
1/2" x 3/8"	3/8"	1/2"	17	21	17	18	50	200
3/4" x 1/4"	1/4"	3/4"	18	21	18	38	80	480
3/4" x 3/8"	3/8"	3/4"	9,5	27	19	46	50	50
3/4" x 1/2"	1/2"	3/4"	18	27	18	34	10	800
1" x 3/8"	3/8"	1"	11	33	20	86	50	50
1" x 1/2"	1/2"	1"	13	34	23	77	50	50
1" x 3/4"	3/4"	1"	14	34	22	55	50	50
1.1/4 x 1"	1"	1.1/4"	13	42	24	97	30	30
1.1/2" x 1/2"	1/2"	1.1/2"	13	48	24	220	10	190
1.1/2" x 1"	1"	1.1/2"	14	48	24	170	10	10

Altre misure su richiesta  
Other sizes on request

**Art.620**

Manicotto

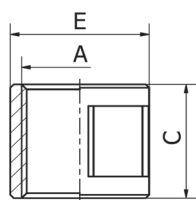
*Socket*

 Disponibile anche nichelato  
 Available also nickel plated

Art.620/N



Misura	A	E	C	gr.		
1/8"	1/8"	14	16	10	10	10
1/4"	1/4"	18	19	16	10	960
3/8"	3/8"	23	26	31	10	750
1/2"	1/2"	26,5	28	44	10	600
3/4"	3/4"	34	33	75	10	240
1"	1"	40	34	95	10	200
1.1/4"	1.1/4"	51	38	171	16	128
1.1/2"	1.1/2"	58	53	280	11	88
2"	2"	71	58	490	6	60
2.1/2"	2.1/2"	88	66	710	1	1
3"	3"	103	80	975	1	1
4"	4"	110	85	1540	1	1

**Art.621**

Manicotto cromato

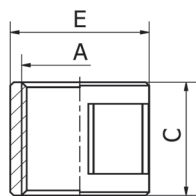
*Chromium plated Socket*

Misura	A	E	C	gr.		
1/8"	1/8"	14	16	10	10	10
1/4"	1/4"	18	19	16	10	960
3/8"	3/8"	23	26	31	10	750
1/2"	1/2"	26,5	29	44	10	600
3/4"	3/4"	34	33	75	10	240
1"	1"	40	34	95	10	200

**Art.625**

Manicotto ridotto

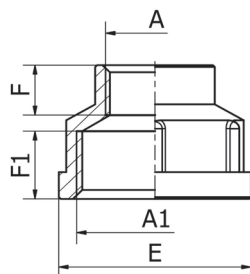
*Reduced socket*

Misura	A	A1	F	F1	E	gr.		
3/8" x 1/4"	1/4"	3/8"	14	15	23	35	10	10
1/2" x 3/8"	3/8"	1/2"	13	12	27	44	10	420
3/4" x 1/2"	1/2"	3/4"	14	15	32	64	10	400
1" x 1/2"	1/2"	1"	14	16	39	79	10	240
1" x 3/4"	3/4"	1"	14	16	39	80	10	240
1.1/4" x 1/2"	1/2"	1.1/4"	12	19	51	153	10	10
1.1/4" x 3/4"	3/4"	1.1/4"	16	19	51	161	10	10
1.1/4" x 1"	1"	1.1/4"	16	18	51	168	10	120
1.1/2" x 1/2"	1/2"	1.1/2"	11	23	58	198	10	10
1.1/2" x 3/4"	3/4"	1.1/2"	14	23	58	210	10	10
1.1/2" x 1"	1"	1.1/2"	14	23	58	226	10	10
1.1/2" x 1.1/4"	1.1/4"	1.1/2"	17	23	58	242	10	10
2" x 1.1/2"	2"	1.1/2"	19	23	70	330	5	5

**Art.630**

Riduzione F.M.

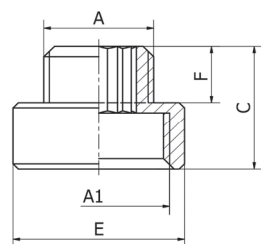
*Reduced extension F.M.*

 \* Con chiave esagonale est.  
 \* With ext. hexagonal wrench

Misura	A	A1	F	E	C	gr.		
1/4" x 1/8"	1/8"	1/4"	9	18	20	17	10	100
3/8" x 1/4"	1/4"	3/8"	9	21	20	20	10	10
1/2" x 1/4"	1/4"	1/2"	9	24	23	26	10	100
1/2" x 3/8"	3/8"	1/2"	9	27	22	36	10	600
3/4" x 3/8"	3/8"	3/4"	9	30	24	39	10	600
3/4" x 1/2"	1/2"	3/4"	11	32	24	52	10	520
1" x 1/2"	1/2"	1"	12	38	27	64	22	264
1" x 3/4"	3/4"	1"	12	38	27	66	10	200
* 1.1/4" x 1"	1"	1.1/4"	12	45	28	92	10	240
* 1.1/2" x 1.1/4"	1.1/4"	1.1/2"	15	52	31	150	24	144

**Art.631**

Riduzione F.M. cromata

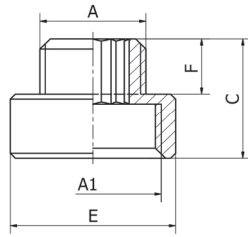
*Chromium plated reduced extension F.M.*



Misura	A	A1	F	E	C	gr.		
1/4" x 1/8"	1/8"	1/4"	9	18	20	17	10	10
3/8" x 1/4"	1/4"	3/8"	9	21	20	20	10	10
1/2" x 1/4"	1/4"	1/2"	9	24	23	26	10	10
1/2" x 3/8"	3/8"	1/2"	9	27	22	36	50	600
3/4" x 3/8"	3/8"	3/4"	9	30	24	39	80	480
3/4" x 1/2"	1/2"	3/4"	11	32	24	52	50	400
1" x 1/2"	1/2"	1"	12	38	27	64	10	250
1" x 3/4"	3/4"	1"	12	38	27	66	10	250
* 1.1/4" x 1"	1"	1.1/4"	12	45	28	72	288	216
* 1.1/2" x 1.1/4"	1.1/4"	1.1/2"	15	52	31	10	10	144

\* Con chiave esagonale est.  
\* With ext. hexagonal wrench

**Art.635**

Tappo maschio

*Male plug*

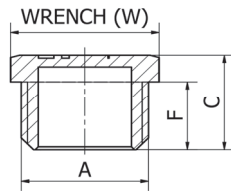

Misura	A	F	C	W	gr.		
1/8"	1/8"	12	16	14	12	100	100
1/4"	1/4"	9	14	17	20	100	1800
3/8"	3/8"	10	14	19	16	20	1000
1/2"	1/2"	11,5	16	21	22	42	1440
3/4"	3/4"	11,5	17	27	36	96	384
1"	1"	10	15	38	70	100	400
1.1/4"	1.1/4"	13,5	26	39	114	16	192
1.1/2"	1.1/2"	13	25	38	145	18	180
2"	2"	18	31	38	281	10	10

**Art.635/OR**

Tappo maschio con O-Ring

*Male plug with O-Ring*



Misura	A		
1/2"	1/2"	10	10
3/4"	3/4"	10	10
1"	1"	10	10
1.1/4"	1.1/4"	10	10
1.1/2"	1.1/2"	10	10
2"	2"	10	10

\* prezzo su richiesta  
\* price on request

**Art.635/T**

Tappo maschio con anello in teflon

*Male plug with ring in teflon*



Misura	A	F	C	W	gr.		
1/2"	1/2"	11,5	16	21	22	10	500

**Art.636**

Tappo maschio cromato

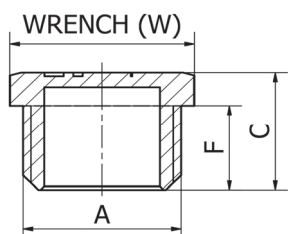
*Chromium plated male plug*

Misura	A	F	C	W	gr.		
1/8"	1/8"	12	16	14	12	10	100
1/4"	1/4"	9	14	17	20	10	100
3/8"	3/8"	10	14	19	16	10	1000
1/2"	1/2"	11	16	21	22	10	500
3/4"	3/4"	11	17	27	36	10	10
1"	1"	10	15	38	70	10	240
1.1/4"	1.1/4"	13,5	26	39	114	24	24
1.1/2"	1.1/2"	13	25	38	145	18	180

**Art.637**

Tappo femmina

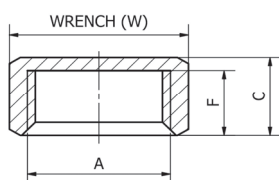
*Female plug*

Misura	A	F	C	W	gr.		
1/8"	1/8"	8	10	14	9	10	100
1/4"	1/4"	8	10	16	10	10	100
3/8"	3/8"	8	11	19	14	10	100
1/2"	1/2"	10	12	23	19	10	960
3/4"	3/4"	12	14	30	38	10	840
1"	1"	36	14	36	51	10	440
1.1/4"	1.1/4"	15	18	47	110	10	25
1.1/2"	1.1/2"	14,5	18	53	141	10	20
2"	2"	17,5	20	65	196	10	10
2.1/2"	2.1/2"	21,5	24	80	285	1	1
3"	3"	18,5	23	95	550	1	1
4"	4"					1	1

**Art.638**

Tappo femmina cromata

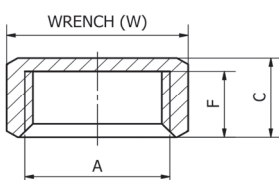
*Chromium plated female plug*

Misura	A	F	C	W	gr.		
1/8"	1/8"	8	10	14	9	10	100
1/4"	1/4"	8	10	16	10	10	100
3/8"	3/8"	8	11	19	14	10	100
1/2"	1/2"	10	12	23	19	10	100
3/4"	3/4"	12	14	30	38	50	50
1"	1"	36	14	36	51	50	50

**Art.639**

Tappo femmina nichelato

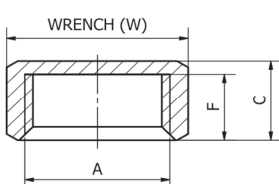
*Female nickel plated plug*

Misura	A	F	C	W	gr.		
1.1/4"	1.1/4"	15	18	47	110	10	25
1.1/2"	1.1/2"	14,5	18	53	141	10	20
2"	2"	17,5	20	65	196	5	5
2.1/2"	2.1/2"	21,5	24	80	285	5	5
3"	3"	18,5	23	95	550	1	1

**Art.623**

Prolunga a 3 vie M.F.F. cromato

*Chromium plated 3 ways extension M.F.F.*

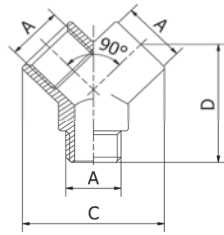

Misura	A	C	D	gr.		
1/2"x1/2"x1/2"	1/2"	52	47	123	51	204

**Art.649**

Prolunga girevole cromata

*Chromium plated swivel extension*

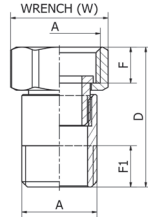

Misura	A	F	F1	W	D	gr.		
1/2" x 1/2"	1/2"	10	12	23	39	52	50	200

**Art.649/G**

Prolunga girevole gialla

*Yellow swivel extension*

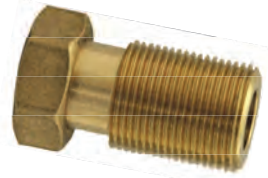

Misura	A	F	F1	W	D	gr.		
3/4" x 3/4"	3/4"	8	33	30	58	146	25	100

**Art.660**

Vite semplice

*Brass screw*

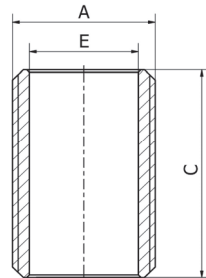

Misura	A	E	C	gr.		
1/2" x 30	1/2"	15	30	31	10	10
3/4" x 30	3/4"	20	30	50	10	10
3/4" x 40	3/4"	20	40	56	35	420
3/4" x 50	3/4"	20,5	50	63	35	350
1" x 33	1"	24,5	33	81	10	10
1.1/4" x 35	1.1/4"	34,5	35	93	15	240
1.1/2" x 40	1.1/2"	39	40	145	10	10
2" x 50	2"	50	50	275	10	10

**Art.661**

Ghiera di riduzione M.F.

*Reduction*



Misura		
1/2" x 3/8"	10	10
3/4" x 1/2"	10	10
1" x 3/4"	10	10
1.1/4" x 1"	10	10
1.1/2" x 1.1/4"	10	10
2" x 1.1/2"	10	10

**Art.661/N**

Ghiera di riduzione M.F. nichelata

*Nickel plated reduction*



Misura		
1/2" x 3/8"	10	10
3/4" x 1/2"	10	10
1" x 3/4"	10	10
1.1/4" x 1"	10	10
1.1/2" x 1.1/4"	10	10
2" x 1.1/2"	10	10

**Art.650**

Prolunga M.F.

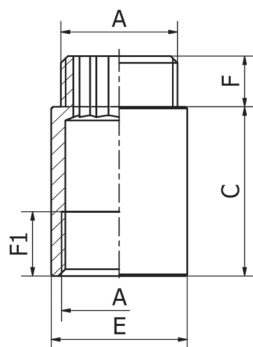
*Extension M.F.*

Misura	A	E	F	F1	C	gr.		
3/8" x 10	3/8"	20	10	7	10	54	54	324
3/8" x 15	3/8"	20	10	12	15	10	10	10
3/8" x 20	3/8"	20	10	15	20	54	54	324
3/8" x 25	3/8"	20	10	15	25	10	10	10
3/8" x 30	3/8"	20	10	15	30	54	54	324
3/8" x 40	3/8"	20	9	9	40	62	10	10
3/8" x 50	3/8"	20	9	13	50	75	54	324
1/2" x 10	1/2"	25	10	15	10	31	10	800
1/2" x 15	1/2"	25	10	15	15	36	10	640
1/2" x 20	1/2"	25	10	15	20	44	10	560
1/2" x 25	1/2"	25	10	15	25	53	10	400
1/2" x 30	1/2"	25	10	15	30	64	10	400
1/2" x 40	1/2"	25	10	15	40	78	10	360
1/2" x 50	1/2"	25	10	15	50	92	10	320
1/2" x 60	1/2"	25	10	15	60	106	10	10
1/2" x 80	1/2"	25	10	15	80	134	10	10
1/2" x 100	1/2"	25	10	15	100	162	10	10
3/4" x 10	3/4"	33	12	15	10	50	10	10
3/4" x 15	3/4"	33	12	15	15	64	10	10
3/4" x 20	3/4"	33	12	15	20	78	10	200
3/4" x 25	3/4"	33	12	15	25	97	20	20
3/4" x 30	3/4"	33	12	15	30	114	10	10
3/4" x 40	3/4"	33	12	15	40	144	10	10
3/4" x 50	3/4"	33	12	15	50	179	30	120
3/4" x 60	3/4"	33	12	15	60	10	10	10
3/4" x 80	3/4"	33	12	15	80	10	10	10
3/4" x 100	3/4"	33	12	15	100	10	10	10
1" x 10	1"	38,5	15	9	10	69	40	320
1" x 15	1"	38,5	15	18	15	91	20	20
1" x 20	1"	38,5	15	17	20	110	18	180
1" x 25	1"	38,5	15	18	25	120	28	168
1" x 30	1"	38,5	15	18	30	138	28	168
1" x 40	1"	38,5	15	18	40	173	15	150
1" x 50	1"	38,5	15	18	50	202	5	120
1" x 60	1"	38,5	15	18	60	5	5	50
1" x 80	1"	38,5	15	18	80	5	5	50
1" x 100	1"	38,5	15	18	100	5	5	50

**Art.684**

Portagomma a "T"

*Tee hose union*

Misura	gr.		
ø 8	10	10	10
ø 10	32	10	10

**Art.685**

Portagomma a CROCE

*Cross hose union*

Misura	gr.		
ø 10	40	10	10

**Art.651**

Prolunga M.F. cromata

*Chromium plated extension M.F.*

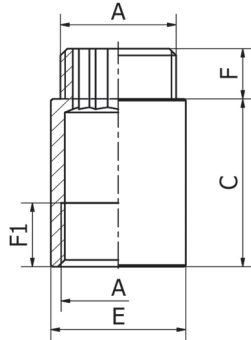

Misura	A	E	F	F1	C	gr.		
3/8" x 10	3/8"	20	10	7	10		10	10
3/8" x 15	3/8"	20	10	12	15		10	10
3/8" x 20	3/8"	20	10	15	20		10	10
3/8" x 25	3/8"	20	10	15	25		10	10
3/8" x 30	3/8"	20	10	15	30		10	10
3/8" x 40	3/8"	20	9	9	40	62	10	10
3/8" x 50	3/8"	20	9	13	50	75	54	324
1/2" x 10	1/2"	25	10	15	10	31	10	800
1/2" x 15	1/2"	25	10	15	15	36	10	640
1/2" x 20	1/2"	25	10	15	20	44	10	400
1/2" x 25	1/2"	25	10	15	25	53	55	440
1/2" x 30	1/2"	25	10	15	30	64	10	320
1/2" x 40	1/2"	25	10	15	40	78	60	360
1/2" x 50	1/2"	25	10	15	50	92	10	320
1/2" x 60	1/2"	25	10	15	60	106	10	10
1/2" x 80	1/2"	25	10	15	80	134	10	10
1/2" x 100	1/2"	25	10	15	100	162	10	10
3/4" x 10	3/4"	33	12	15	10	50	10	10
3/4" x 15	3/4"	33	12	15	15	64	10	10
3/4" x 20	3/4"	33	12	15	20	78	10	200
3/4" x 25	3/4"	33	12	15	25	97	20	20
3/4" x 30	3/4"	33	12	15	30	114	10	10
3/4" x 40	3/4"	33	12	15	40	144	10	10
3/4" x 50	3/4"	33	12	15	50	179	10	120
3/4" x 60	3/4"	33	12	15	60		10	10
3/4" x 80	3/4"	33	12	15	80		10	10
3/4" x 100	3/4"	33	12	15	100		10	10
1" x 10	1"	38,5	15	9	10	69	40	320
1" x 15	1"	38,5	15	18	15	91	20	20
1" x 20	1"	38,5	15	17	20	110	18	180
1" x 25	1"	38,5	15	18	25	120	28	168
1" x 30	1"	38,5	15	18	30	138	28	168
1" x 40	1"	38,5	15	18	40	173	15	150
1" x 50	1"	38,5	15	18	50	202	25	100
1" x 60	1"	38,5	15	18	60		5	50
1" x 80	1"	38,5	15	18	80		5	50
1" x 100	1"	38,5	15	18	100		5	50

**Art.686**

Portagomma a 120°

*120° hose union*



Misura	gr.		
ø 8		10	10
ø 10	39	10	10
ø 14	40	10	10

**Art.687**

Portagomma a "Y"

*Y hose union*





Misura	gr.		
ø 10	35	10	10

**Art.659**

Prolunga barilotto M.M.

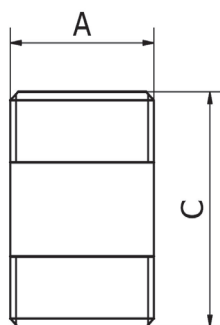
Extension M.M.



Misura	A	C	gr.		
1/2" x 40	1/2"	40	45	10	10
1/2" x 50	1/2"	50	55	48	576
1/2" x 55	1/2"	55	61	10	10
1/2" x 60	1/2"	60	67	10	10
1/2" x 70	1/2"	70	78	10	10
1/2" x 75	1/2"	75	83	56	224
1/2" x 80	1/2"	80	89	10	10
1/2" x 100	1/2"	100	111	20	200
1/2" x 125	1/2"	125	139	10	10
1/2" x 150	1/2"	150	166	12	120
1/2" x 175	1/2"	175	194	10	10
1/2" x 200	1/2"	200	222	10	100
1/2" x 225	1/2"	225	250	10	10
1/2" x 250	1/2"	250	277	10	10
1/2" x 300	1/2"	300	333	5	5
1/2" x 400	1/2"	400	444	5	5
1/2" x 500	1/2"	500	555	1	40
1/2" x 1000	1/2"	1000	1260	1	1
3/4" x 50	3/4"	50	80	30	300
3/4" x 60	3/4"	60	96	10	10
3/4" x 65	3/4"	65	104	10	10
3/4" x 70	3/4"	70	111	10	10
3/4" x 75	3/4"	75	119	10	10
3/4" x 80	3/4"	80	127	10	10
3/4" x 100	3/4"	100	159	16	160
3/4" x 110	3/4"	110	215	10	10
3/4" x 120	3/4"	120	191	10	10
3/4" x 125	3/4"	125	199	10	10
3/4" x 150	3/4"	150	239	10	150
3/4" x 175	3/4"	175	278	10	10
3/4" x 200	3/4"	200	318	10	80
3/4" x 225	3/4"	225	358	10	10
3/4" x 250	3/4"	250	398	10	10
3/4" x 300	3/4"	300	477	5	5
3/4" x 400	3/4"	400	636	5	5
3/4" x 500	3/4"	500	795	1	20
3/4" x 1000	3/4"	1000	2050	1	1
1" x 50	1"	50	128	10	10
1" x 60	1"	60	154	10	10
1" x 65	1"	65	166	10	10
1" x 70	1"	70	179	10	10
1" x 75	1"	75	192	10	10
1" x 80	1"	80	205	28	112
1" x 85	1"	85	223	28	112
1" x 100	1"	100	256	10	10
1" x 120	1"	120	307	10	10
1" x 125	1"	125	320	10	10
1" x 150	1"	150	384	10	10
1" x 175	1"	175	448	10	10
1" x 190	1"	190	575	10	10
1" x 200	1"	200	511	10	10
1" x 250	1"	250	639	10	10
1" x 300	1"	300	767	5	5
1" x 400	1"	400	1022	5	5
1" x 500	1"	500	1279	5	5
1" x 1000	1"	1000	3120	1	1
1.1/4" x 50	1.1/4"	50	182	10	10
1.1/4" x 60	1.1/4"	60	218	10	10
1.1/4" x 70	1.1/4"	70	254	10	10
1.1/4" x 80	1.1/4"	80	291	10	10
1.1/4" x 90	1.1/4"	90	327	10	10
1.1/4" x 100	1.1/4"	100	363	10	10
1.1/4" x 120	1.1/4"	120	436	5	5
1.1/4" x 130	1.1/4"	130	472	5	5



**Art.659**

Prolunga barilotto M.M.

Extension M.M.

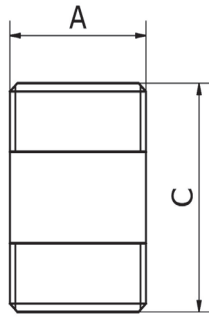

Misura	A	C	gr.		
1.1/4" x 150	1.1/4"	150	545	5	5
1.1/4" x 180	1.1/4"	180	654	5	5
1.1/4" x 200	1.1/4"	200	726	5	5
1.1/4" x 250	1.1/4"	250	908	5	5
1.1/4" x 300	1.1/4"	300	1089	1	1
1.1/4" x 400	1.1/4"	400	1561	1	1
1.1/4" x 500	1.1/4"	500	1924	1	1
1.1/2" x 50	1.1/2"	50	182	10	10
1.1/2" x 60	1.1/2"	60	218	10	10
1.1/2" x 70	1.1/2"	70	255	10	10
1.1/2" x 80	1.1/2"	80	291	10	10
1.1/2" x 90	1.1/2"	90	327	10	10
1.1/2" x 100	1.1/2"	100	364	10	10
1.1/2" x 120	1.1/2"	120	436	5	5
1.1/2" x 130	1.1/2"	130	472	5	5
1.1/2" x 150	1.1/2"	150	545	5	5
1.1/2" x 180	1.1/2"	180	654	5	5
1.1/2" x 200	1.1/2"	200	727	5	5
1.1/2" x 250	1.1/2"	250	908	5	5
1.1/2" x 300	1.1/2"	300	1090	1	1
2" x 50	2"	50	293	5	5
2" x 60	2"	60	351	5	5
2" x 70	2"	70	410	5	5
2" x 80	2"	80	468	5	5
2" x 100	2"	100	585	5	5
2" x 120	2"	120	703	5	5
2" x 150	2"	150	820	5	5
2" x 190	2"	190	1112	5	5
2" x 200	2"	200	1170	5	5
2" x 250	2"	250	1463	5	5
2" x 300	2"	300	1756	1	1

Altre misure disponibili su richiesta  
Other sizes available on request

**Art.657**

Barilotto scorrevole

Brass sliding extension





Misura		
1/2" x 100	5	5
1/2" x 150	5	5
1/2" x 200	5	5
3/4" x 100	5	5
3/4" x 150	5	5
3/4" x 200	5	5
1" x 100	3	3
1" x 150	3	3
1" x 200	3	3

Altre misure su richiesta  
Other sizes on request

**Art.680**

Gomito portag. M.GAS METANO DN15



*Male elbow hose connector GAS METHANE DN15*

Misura	A	F	E	C	D	gr.		
3/8" x 15	3/8"	10,5	15	38	27	75	10	10
1/2" x 15	1/2"	10,5	15	38	22	75	10	10

**Art.681**

Gomito portag. F.GAS METANO DN15



*Female elbow hose connector GAS METHANE DN15*

Misura	A	F	E	C	D	gr.		
3/8" x 15	3/8"	10,5	15	38	27	75	10	10
1/2" x 15	1/2"	10,5	15	38	22	75	10	10

**Art.682**

Gomito portagomma M.per GPL DN10



*Male elbow hose connector LPG DN10*

Misura	A	F	E	C	D	gr.		
3/8" x 10	3/8"	10,5	10	38	27	72	10	10
1/2" x 10	1/2"	10,5	10	38	22	74	10	10

**Art.683**

Gomito portagomma F. per GPL DN10

*Female elbow hose connector LPG DN10*

Misura	A	F	E	C	D	gr.		
3/8" x 10	3/8"	10,5	10	38	27	72	10	10
1/2" x 10	1/2"	10,5	10	38	22	74	10	10

**Art.680/D** Portagomma M.GAS METANO DN15

*Male elbow hose connector GAS METHANE DN15*



Misura	A	F	E	C	D	gr.		
3/8" x 15	3/8"					33	10	10
1/2" x 15	1/2"					35	10	10

**Art.681/D** Portagomma F.GAS METANO DN15

*Female elbow hose connector GAS METHANE DN15*



Misura	A	F	E	C	D	gr.		
3/8" x 15	3/8"					37	10	10
1/2" x 15	1/2"					41	10	10

**Art.682/D** Portagomma M.per GPL DN10

*Male elbow hose connector LPG DN10*



Misura	A	F	E	C	D	gr.		
3/8" x 10	3/8"					29	10	10
1/2" x 10	1/2"					32	10	10

**Art.683/D** Portagomma F. per GPL DN10

*Female elbow hose connector LPG DN10*



Misura	A	F	E	C	D	gr.		
3/8" x 10	3/8"					35	10	10
1/2" x 10	1/2"					39	10	10

**Art.2280** Scarico IN ACCIAIO INOX 316

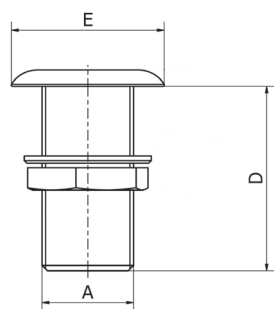
*Discharge in Stainless steel*

Misura	A	E	D	Ø	gr.		
3/8"	3/8"	35	54	11	78	1	120
1/2"	1/2"	40	59	15	99	1	100
3/4"	3/4"	47	65	19	197	1	80
1"	1"	55	73	25	278	1	60
1.1/4"	1.1/4"	64	77	34	378	1	40
1.1/2"	1.1/2"	75	83	38	496	1	35
2"	2"	84	95	50	733	1	25
2.1/2"	2.1/2"	110	124	65		1	15

 Con collegamento a massa  
 Lucidati a specchio

*With ground connection  
 Polished*

**IN ACCIAIO INOX AISI 316**  
**IN STAINLESS STEEL AISI 316**

**Art.280** Scarico

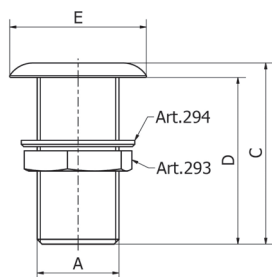
*Discharge*

Misura	A	E	C	D	gr.		
3/8"	3/8"	36	57	52	86	35	350
1/2"	1/2"	40	63	58	120	28	224
3/4"	3/4"	47	72	67	200	18	144
1"	1"	56	76	70	306	12	96
1.1/4"	1.1/4"	65	83	77	415	9	72
1.1/2"	1.1/2"	72	84	78	557	10	40
2"	2"	83	102	95	864	1	30

**Art.293** Controdado pesante

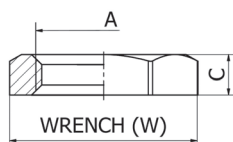
*Heavy lock nut*

Misura	A	W	C	gr.		
1/4"	1/4"	17	5	5	50	50
3/8"	3/8"	22	6	11	50	50
1/2"	1/2"	24	8	11	50	50
3/4"	3/4"	32	8	23	25	25
1"	1"	40	8,5	40	20	20
1.1/4"	1.1/4"	48	8,5	49	10	10
1.1/2"	1.1/2"	58	8,5	86	10	10
2"	2"	70	11	128	5	5

**Art.293/R** Controdado standard

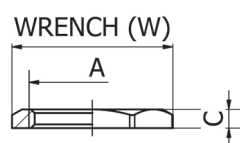
*Standard lock nut*

Misura	A	W	C	gr.		
1/2"	1/2"	24	5	8	50	50
3/4"	3/4"	31	6	15	50	50
1"	1"	37	5	25	40	40

## COLLETTORI PER IRRIGAZIONE IN OTTONE NICHELATO

### MANIFOLDS FOR IRRIGATION IN BRASS NICKEL PLATED

**Art.1400** Angolo M.F.

*Elbow M.F.*



Misura	gr.		
1"	189	10	120

**O-Ring di tenuta integrata**
*Built-in O-Ring*
**Art.1405** Angolo F.F.

*Elbow F.F.*

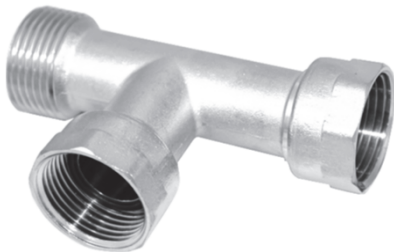

Misura	gr.		
1"	208	10	120

**O-Ring di tenuta integrata**
*Built-in O-Ring*
**Art.1410** Tee Modulo 1

*Tee Module 1*

Misura	gr.		
1"	284	5	100

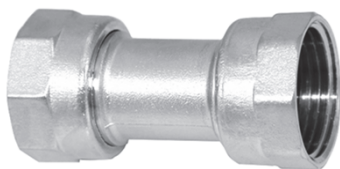
**O-Ring di tenuta integrata**
*Built-in O-Ring*
**Art.1415** Giunto diretto F.F.

*Straight joint F.F.*

Misura	gr.		
1"	155	10	200

**O-Ring di tenuta integrata**
*Built-in O-Ring*
**Art.1420** Doppio Tee Modulo 2

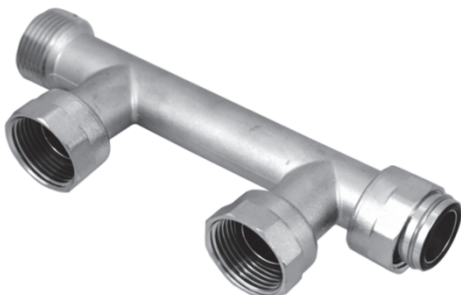
*Double Tee Module 2*

Misura	gr.		
1"	492	5	50

**O-Ring di tenuta integrata**
*Built-in O-Ring*

**Art.1425** Tappo con foro riduzione 1/2"

*Plug with reduction hole 1/2"*

Misura	gr.		
1"	52	10	500

**Art.1430** Giunto M.F.

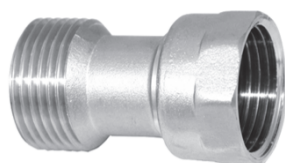
*Joint M.F.*

Misura	gr.		
1"	130	10	200

**O-Ring di tenuta integrata**
*Built-in O-Ring*
**Art.1435** Tappo femmina

*Female plug*

Misura	gr.		
1"	54	10	300

**Art.1480** Niplo ridotto con OR

*Reduced nipple with OR*



Misura	gr.		
1"x3/4"	80	10	300

**Art.1490** Niplo con OR

*Nipple with OR*

Misura	gr.		
1"	91	10	300

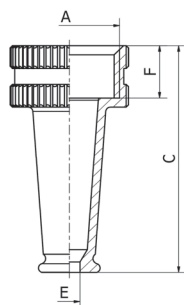
**Art.210** Lancia di lavaggio

*Hose pipe nozzle*

Misura	A	E	F	C	gr.		
1/2"	1/2"	4,5	12	50	31	100	100
3/4"	3/4"	4,5	12	50	48	50	50

 Foro uscita  $\varnothing 4,5$  ( $\varnothing 8$  su richiesta Art.210/S)  
 Outlet hole  $\varnothing 4,5$  ( $\varnothing 8$  on request Art.210/S)

**Art.213**

Lancia di lavaggio fissa con portagomma

*Hose pipe nozzle with hose connector*

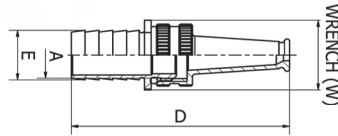

Misura	A	E	W	D	gr.		
1/2" x 20	1/2"	20	24	82	69	50	50
3/4" x 20	3/4"	20	29	88	90	50	50
3/4" x 25	3/4"	25	29	90	100	50	50

Foro uscita  $\varnothing 4,5$  ( $\varnothing 8$  su richiesta)  
Exit hole  $\varnothing 4,5$  ( $\varnothing 8$  on request)

**Art.350**

Portagomma con ghiera nichelati

*Nickel plated hose ring*

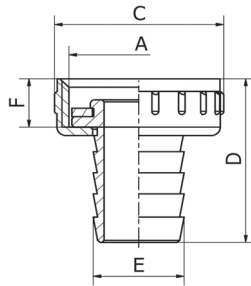

Misura	A	E	F	C	D	gr.		
1/2" x 3/4"	3/4"	15	10	30	33	18	50	50
3/4" x 1"	1"	20	10	36	39	56	50	50
1" x 1.1/4"	1.1/4"	26	11	46	49	80	25	25

**Art.351**

Portagomma con ghiera per rubinetto

*Hose ring*

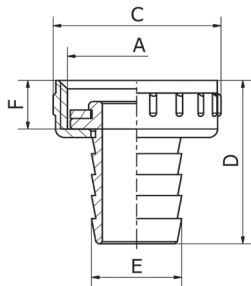

Misura	A	E	F	C	D	gr.		
1" x 19	1"	19	10	37	37	68	50	50
1" x 20	1"	20	10	37	38	60	50	50

**Art.242**

Raccordo portagomma

*Hose connector*

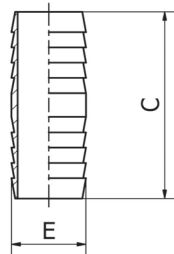

Misura	E	C	gr.		
3/8" x $\varnothing$ 12	12	50	19	10	10
1/2" x $\varnothing$ 15	15	55	24	10	10
3/4" x $\varnothing$ 21	21	55	42	10	10
1" x $\varnothing$ 27	27	55	55	10	10
1.1/4" x $\varnothing$ 32	32	68	103	10	10
2" x $\varnothing$ 53	53	88	406	10	10

**Art.243**

Raccordo a "T" portagomma

*Tee hose connector*

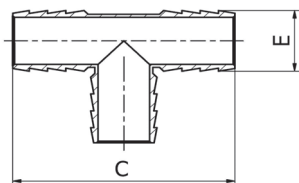

Misura	E	C	gr.		
1/2" x $\varnothing$ 15	$\varnothing$ 15	55	69	10	10
5/8" x $\varnothing$ 17	$\varnothing$ 17	55	51	10	10
3/4" x $\varnothing$ 20	$\varnothing$ 20	68	58	10	10
1" x $\varnothing$ 25	$\varnothing$ 25	74	105	10	10
1.1/4" x 31	$\varnothing$ 31	120	300	1	78

**Art.530** Raccordo rapido cieco

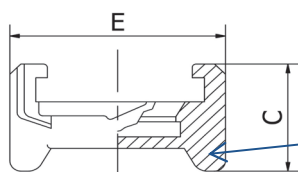
*Blind quick connection*

Misura	E	C	gr.		
	57	31	92	48	48

 Con foro  $\varnothing 3,5$ mm sull'aletta  
 With hole  $\varnothing 3,5$  mm on the wing

**Art.535** Raccordo rapido maschio

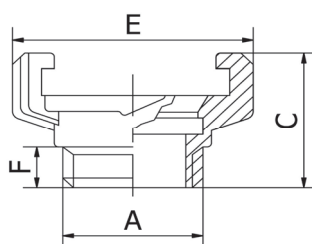
*Male quick connection*

Misura	A	F	E	C	gr.		
3/8"	3/8"	10	60	32	85	40	240
1/2"	1/2"	10	57	34	70	40	240
3/4"	3/4"	10	57	34	77	40	240
1"	1"	10	57	34	82	40	240
1.1/4"	1.1/4"	16	57	38	100	15	240
1.1/2"	1.1/2"	12	60	41	104	10	10

**Art.540** Raccordo rapido femmina

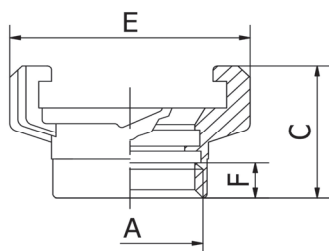
*Female quick connection*

Misura	A	F	E	C	gr.		
3/8"	3/8"	11	57	33	85	10	10
1/2"	1/2"	9	57	33	70	40	240
3/4"	3/4"	9,5	57	34	79	40	240
1"	1"	11	57	35	78	40	240
1.1/4"	1.1/4"	15	57	39	131	30	240
1.1/2"	1.1/2"	14	57	40	140	10	10

**Art.545** Raccordo rapido portagomma

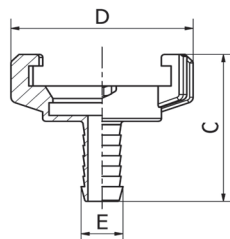
*Quick connection with hose connector*

Misura	A	E	C	D	gr.		
$\varnothing 13$	3/8"	13	57	57	87	18	216
$\varnothing 15$	1/2"	15	57	57	72	18	216
$\varnothing 18$	5/8"	18	57	57	103	18	216
$\varnothing 20$	3/4"	20	55	57	83	18	160
$\varnothing 25$	1"	25	62	57	111	15	216
$\varnothing 30$	1.1/4"	30	62	57	136	15	180
$\varnothing 32$	1.1/4"	32	67	57	119	10	10
$\varnothing 35$	1.1/4"	35	70	57	169	20	160
$\varnothing 40$	1.1/2"	40	76	60	155	10	10
* $\varnothing 15$	15	15	73	60	183	10	10
* $\varnothing 25$	25	25	81	60	250	8	8

**Art.545/S**

 \* Raccordo rapido per alta pressione  
 \* Rapid connection for high pressure

**Art.550** Guarnizione per raccordo rapido

*Gasket for quick connection*

 NBR 75SH ad elevata  
 resistenza

 NBR 75SH with high  
 resistance

Misura		
	500	1000

Disponibile anche in VITON (Art.550/V)

Available also in VITON (Art.550/V)





**Art.560**

Raccordo femmina attacco rapido

*Brass female quick fitting*



**Art.560/C**

Misura		
1/2"	40	560
3/4"	40	560

Raccordo F. attacco rapido CROMATO *Chrome plated quick fitting*

Misura		
1/2"	40	560
3/4"	40	560

**Art.3007**

Preso rapida per acqua

*Brass inlet clamp saddle*

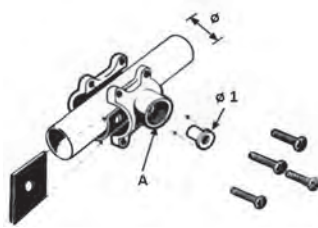

Misura	Ø	Ø 1	A	
1/2" x 1/2"	1/2"	Ø10	1/2"	10
3/4" x 1/2"	3/4"	Ø10	1/2"	10
1" x 1/2"	1"	Ø10	1/2"	10
1" x 3/4"	1"	Ø10	3/4"	10
1.1/4" x 3/4"	1.1/4"	Ø16	3/4"	5
1.1/2" x 3/4"	1.1/2"	Ø16	3/4"	5
1.1/2" x 2"	2"	Ø27	1.1/2"	5

**Art.562**

Raccordo 3 vie a sfera M.M.F.

*3 ways quick connector M.M.F.*



Misura		
3/4"	10	10

**Art.563**

Raccordo 3 vie a sfera con attacco rapido

*3 ways quick connector*



Misura		
3/4"	10	10

**Art.6590**

Tubo estensibile per irrigazione

*Extensible hose for garden*



Misura	
2,5 - 7,5 Mt	1
5 - 15 Mt	1

**Art.1200/N** Collettore di distribuzione con volantini

*Manifold with handwheels*

Misura	A	A1	E	D	C	gr.		
3/4" x 1/2" x 2	3/4"	1/2"	35	75	91	400	5	50
3/4" x 1/2" x 3	3/4"	1/2"	35	75	126	475	5	50
3/4" x 1/2" x 4	3/4"	1/2"	35	75	170	608	5	50
1" x 1/2" x 2	1"	1/2"	35	78	100	400	5	50
1" x 1/2" x 3	1"	1/2"	35	78	126	550	5	25
1" x 1/2" x 4	1"	1/2"	35	78	162	701	5	25

 Volantini bianchi  
Con dischetti rosso-blu

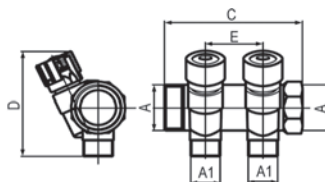
*White handwheels  
With disks red-blue*

**Art.1203** Raccordo ad angolo 105° per PEX

*Elbow fitting 105° for PEX*

Misura	A	E	gr.		
1/2"x16x2	1/2"	16	95	5	10
1/2"x16x2,2	1/2"	16	98	1	10

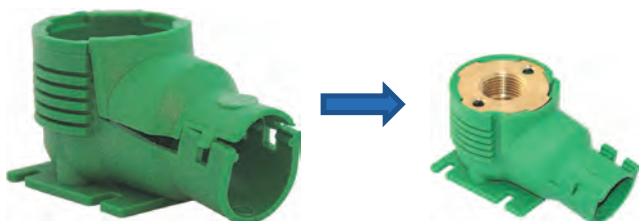
**Art.1204** Custodia in plastica per Art.1203

*Plastic cover for Art.1203*

gr.		
36	10	10

**Art.1205** Adattatore tubo multistrato

*Multilayer tube adapter*

Misura	A	W	E	gr.		
1/2"x14x2	1/2"	24	14	44	10	10
1/2"x16x2	1/2"	24	16	46	10	10

**Art.1206** Adattatore tubo PEX

*PEX tube adapter*

Misura	A	W	E	gr.		
1/2"x16x2	1/2"	24	14	40	10	10
1/2"x16x2,2	1/2"	24	16	40	10	10

**Art.1210** Collettore da barra interasse 36mm

*Manifolds made of brass rod with female offtakes interaxis 36mm*

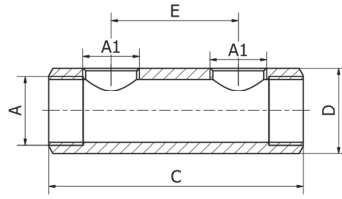

Misura	A	A1	E	C	D	gr.		
3/4" x 1/2" 2 vie	3/4"	1/2"	36	72	35	220	5	5
3/4" x 1/2" 3 vie	3/4"	1/2"	36	108	35	332	5	5
3/4" x 1/2" 4 vie	3/4"	1/2"	36	144	35	445	5	5
1" x 1/2" 2 vie	1"	1/2"	36	72	41	258	5	5
1" x 1/2" 3 vie	1"	1/2"	36	108	41	392	5	5
1" x 1/2" 4 vie	1"	1/2"	36	144	41	523	5	5

**Disponibili fino a 12 uscite e misure maggiori, prezzi su richiesta**

*Available till 12 ways and bigger sizes, prices on request*

**Art.1211** Collettore da barra interasse 50mm

*Manifolds made of brass rod with female offtakes interaxis 50mm*

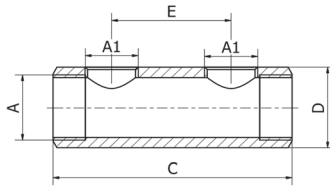

Misura	A	A1	E	C	D	gr.		
3/4" x 1/2" 2 vie	3/4"	1/2"	50	100	35	319	5	5
3/4" x 1/2" 3 vie	3/4"	1/2"	50	150	35	481	5	5
3/4" x 1/2" 4 vie	3/4"	1/2"	50	200	35	644	5	5
1" x 1/2" 2 vie	1"	1/2"	50	100	41	373	5	5
1" x 1/2" 3 vie	1"	1/2"	50	150	41	560	5	5
1" x 1/2" 4 vie	1"	1/2"	50	200	41	749	5	5

**Disponibili fino a 12 uscite e misure maggiori, prezzi su richiesta**

*Available till 12 ways and bigger sizes, prices on request*

Collettore lineare maschio

*Male threaded manifolds 2 ways, 1/2" - 16*

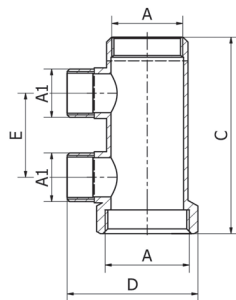

**Art.1250 a 2 vie**

Misura	A	A1	E	C	D	gr.		
3/4" x 1/2" 2 vie	3/4"	1/2"	37	84	50	185	5	5
1" x 1/2" 2 vie	1"	1/2"	37	84	53	266	5	5

**Art.1255 a 3 vie**

Misura	A	A1	E	C	D	gr.		
3/4" x 1/2" 3 vie	3/4"	1/2"	37	119	50	245	5	5
1" x 1/2" 3 vie	1"	1/2"	37	119	53	356	5	5

**Art.1260 a 4 vie**

Misura	A	A1	E	C	D	gr.		
3/4" x 1/2" 4 vie	3/4"	1/2"	37	155	50	305	5	5
1" x 1/2" 4 vie	1"	1/2"	37	155	53	438	5	5

**Art.1261 a 5 vie**

Misura	A	A1	E	C	D	gr.		
3/4" x 1/2" 5 vie	3/4"	1/2"	37	190	50	405	5	5
1" x 1/2" 5 vie	1"	1/2"	37	190	53	520	5	5

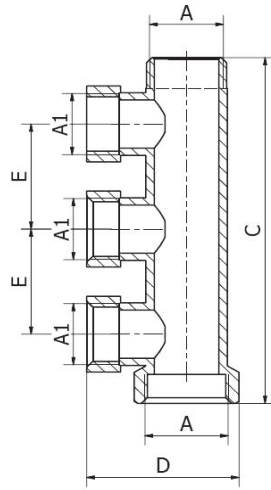
**Collettore lineare femmina**
*Female threaded manifolds 2 ways*

**Art.1265 a 2 vie**

Misura	A	A1	E	C	D	gr.		
3/4" x 1/2" 2 vie	3/4"	1/2"	37	84	50	197	5	5
1" x 1/2" 2 vie	1"	1/2"	37	84	53	218	5	5

**Art.1270 a 3 vie**

Misura	A	A1	E	C	D	gr.		
3/4" x 1/2" 3 vie	3/4"	1/2"	37	119	50	277	5	5
1" x 1/2" 3 vie	1"	1/2"	37	119	53	329	5	5

**Art.1275 a 4 vie**

Misura	A	A1	E	C	D	gr.		
3/4" x 1/2" 4 vie	3/4"	1/2"	37	155	50	381	5	5
1" x 1/2" 4 vie	1"	1/2"	37	155	53	430	5	5

**Art.1280 a 5 vie**

Misura	A	A1	E	C	D	gr.		
3/4" x 1/2" 5 vie	3/4"	1/2"	37	190	50	480	5	5
1" x 1/2" 5 vie	1"	1/2"	37	190	53	525	5	5

**Art.1285**
**Collettore lineare con minivalvole**
*Threaded manifolds with mini ball valves*

Misura	A	A1		
3/4" x 1/2" 2 vie	3/4"	1/2"	5	5
3/4" x 1/2" 3 vie	3/4"	1/2"	5	5
3/4" x 1/2" 4 vie	3/4"	1/2"	5	5
3/4" x 1/2" 5 vie	3/4"	1/2"	5	5
3/4" x 1/2" 6 vie	3/4"	1/2"	5	5
1" x 1/2" 2 vie	1"	1/2"	5	5
1" x 1/2" 3 vie	1"	1/2"	5	5
1" x 1/2" 4 vie	1"	1/2"	5	5
1" x 1/2" 5 vie	1"	1/2"	5	5
1" x 1/2" 6 vie	1"	1/2"	5	5

Interasse 36 mm

*Interaxis 36 mm*

## CONTATORI D'ACQUA Water Meters

**Art.1461** Contatore in linea a getto unico

*Single-jet Water Meters*



DN	m³/h	Ø tubo	attacco contatore	L	
15	1,6	1/2"	3/4"	110	300
20	2,5	3/4"	1"	130	150

Contatore in linea a getto unico *Single-jet meters*  
 A quadrante asciutto *Dry Dial counter*  
 Adatto per acqua fredda (30°C) *For cold water up to 30°*  
 Orologeria a 8 rulli numeratori *Counter equipped with 8 reels*  
 Completo di raccordi in ottone *With brass fittings*  
 Adatto per installazione sia verticale che orizzontale *Can be installed horizontally or vertical.*  
 Pressione di esercizio PN 10 *Pressure stage PN 10*

**Art.1462** Contatore in linea a getto unico

*Single-jet Water Meters*



DN	m³/h	Ø tubo	attacco contatore	L	
15	1,6	1/2"	3/4"	110	300
20	2,5	3/4"	1"	130	150

Contatore in linea a getto unico *Single-jet meter*  
 A quadrante asciutto *Dry Dial counter*  
 Adatto per acqua calda (90°C) *For hot water up to 90°*  
 Orologeria a 8 rulli numeratori *Counter equipped with 8 reels*  
 Completo di raccordi in ottone *With brass fittings*  
 Adatto per installazione sia verticale che orizzontale *Can be installed horizontally or vertical.*  
 Pressione di esercizio PN 10 *Pressure stage PN 10*

**Art.1463** Modulo lanciaimpulsi (getto unico)

*Impulse module (single-jet)*



\* Per contatore a getto unico  
 \* For single-jet water meter

	1
--	---

**Art.1464** Modulo lanciaimpulsi (getto multiplo)

*Impulse module (multi-jet)*

\* Per contatore a getto multiplo  
 \* For multi-jet water meter

	1
--	---

**Art.1460** Contatore a getto multiplo

*Multi-jet water meters*



Con raccordi  
 With fittings

DN	m³/h	corpo/body	raccordo/fitting		
15	1/2"	2,5	3/4"	1/2"	1
20	3/4"	4	1"	3/4"	1
25	1"	6,3	1.1/4"	1"	1
32	1.1/4"	10	1.1/2"	1.1/4"	1
40	1.1/2"	16	2"	1.1/2"	1
50	2"	25	2.1/2"	2"	1

Contatore a getto unico *Multi-jet meters*  
 A quadrante asciutto *Dry Dial counter*  
 Adatto per acqua fredda (30°C) *For cold water up to 30°*  
 Completo di raccordi in ottone *With brass fittings*  
 Adatto per installazione sia verticale che orizzontale *Can be installed horizontally or vertical.*  
 Pressione di esercizio PN 16 *Pressure PN 16*

## ACCESSORI PER SERBATOI ACCESSORIES FOR TANKS

**Art.5000** Tagliafiamma con reticella

*Flame trap with wire gauze*



Misura		
1.1/2"	6	60

**Art.5100** Tappo a chiusura rapida

*Plug quick connection*



Misura		
3"	1	20

**Art.5150** Ghiera

*Ring quick connection*



Misura		
2.1/2"	1	20
3"	1	20

**Art.5200** Valvola limitatrice di carico

*Overflow prevention valve*

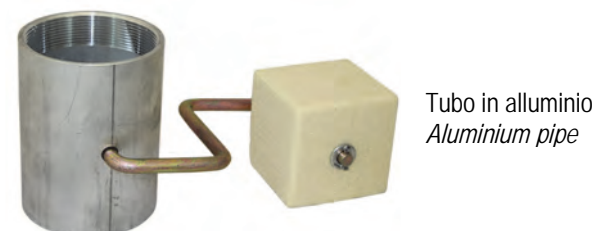

Misura	L		
3"	127	1	12

**Art.5210** Valvola limitatrice di carico

*Overflow prevention valve M.F.*



Misura	L		
3"x255	255	1	8
3"x500	500	1	4

**Art.637/S** Tappo con asola

*Plug with*

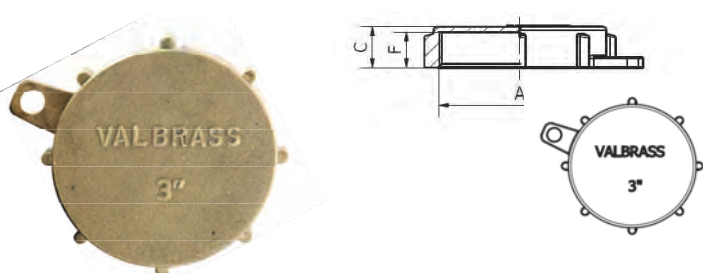

Misura	A	F	C	gr.		
3"	3"	20	23	396	10	100

## PNEUMATICA

### *Pneumatics*

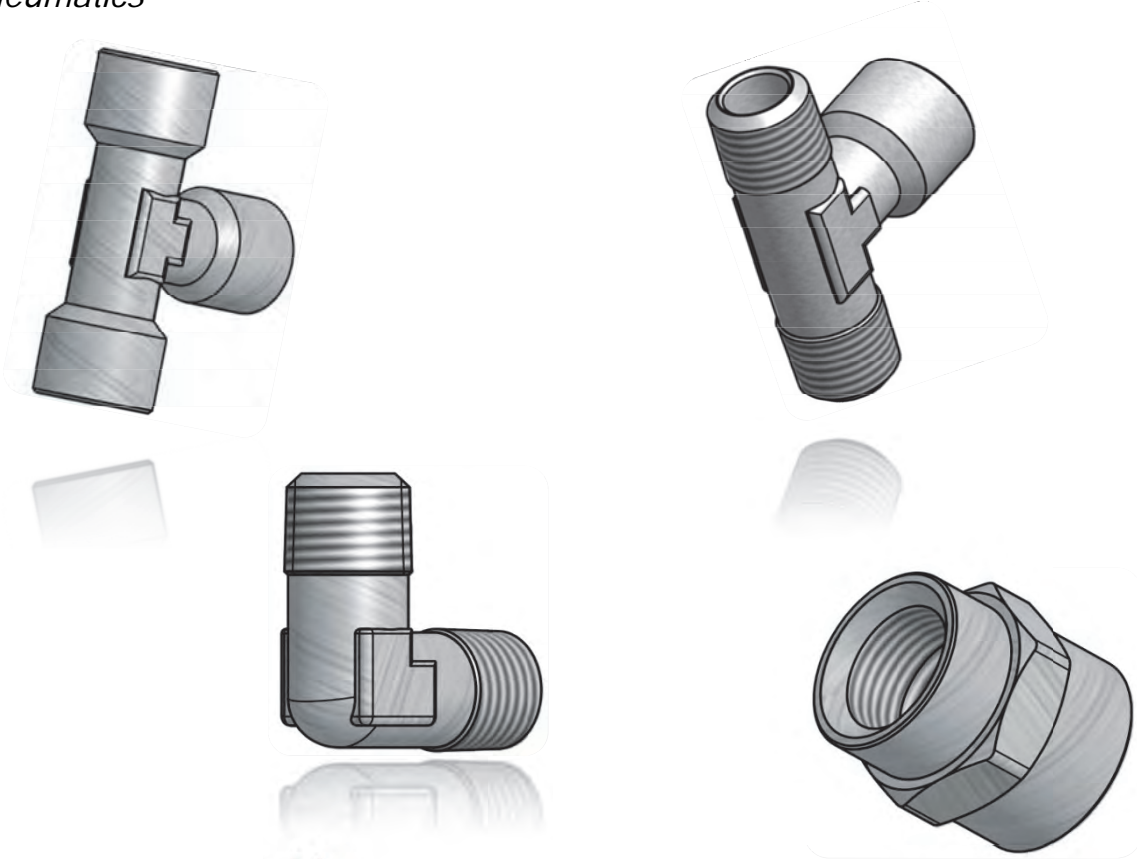

### Caratteristiche tecniche

#### *Technical features*

Materiale utilizzato : Ottone CW614N UNI EN 12164  
Ottone CW617N UNI EN 12164

Filettature : ISO 228 / ISO 7

Trattamento superficiale : Nichelatura

La pressione massima di esercizio e la temperatura è determinata dalle caratteristiche del tubo impiegato .

Pressione massima consigliata 18 bar

Campi d'impiego : circuiti pneumatici , oleodinamici e idraulici

*Material used : Brass CW614N UNI EN 12164  
Brass CW617N UNI EN 12164*

*Threads : ISO 228 / ISO 7*

*Surface finish : Nickel plated*

*The maximum working pressure and working temperature depend on which type of tube is used.*

*Max pressure suggested : 18 bar*

*Fields of use : pneumatic and hydraulic systems*

**Art.900** Raccordo a "T" F.F.F.

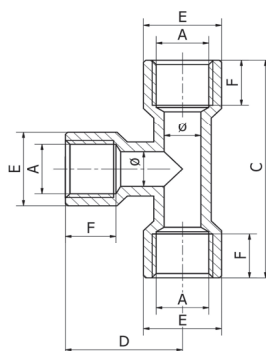
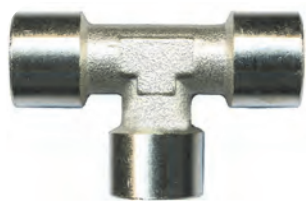
*Tee F.F.F.*

Misura	A	F	ø	E	C	D	gr.	
1/8"	1/8"	8	6	13	42	21	29	100
1/4"	1/4"	11	8	17	51	25,5	59	100
3/8"	3/8"	11,5	11	21	56	28	84	100
1/2"	1/2"	14	15	26	67	33,5	144	50

**Art.900/L** Modello leggero  
*Light model*

Misura	A	F	CH	C	D	
1/8"	1/8"	8	10	37	18,5	100
1/4"	1/4"	11	13	45	22,5	100
3/8"	3/8"	11,5	17	51	25,5	100
1/2"	1/2"	14	21	60	30	50

**Art.905** Raccordo a "T" F.M.F.

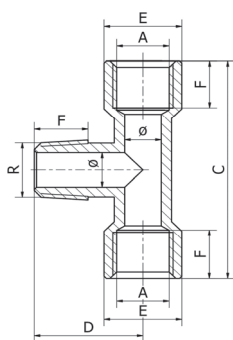
*Tee F.M.F.*

Misura	A/R	F	ø	E	C	D	gr.	
1/8"	1/8"	8	6	13	42	18,5	25	100
1/4"	1/4"	11	8	17	51	23,5	51	100
3/8"	3/8"	11,5	11	21	56	26	75	100
1/2"	1/2"	14	15	26	67	31	127	50

**Art.905/L** Modello leggero  
*Light model*

Misura	A	F	CH	C	D	
1/8"	1/8"	8	10	37	17	100
1/4"	1/4"	11	12	45	22,5	100
3/8"	3/8"	11,5	15	51	25,5	100
1/2"	1/2"	14	19	60	30	50

**Art.910** Raccordo a "T" M.M.F.

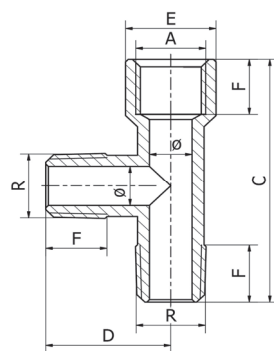
*Tee M.M.F.*

Misura	A/R	F	ø	E	C	D	gr.	
1/8"	1/8"	8	6	13	39,5	18,5	23	100
1/4"	1/4"	11	8	17	49	23,5	44	100
3/8"	3/8"	11,5	11	21	54	26	65	100
1/2"	1/2"	14	15	26	64,5	31	110	50

**Art.910/L** Modello leggero  
*Light model*

Misura	A/R	F	CH	C	D	
1/8"	1/8"	8	6	42	21	100
1/4"	1/4"	11	8	51	25,5	100
3/8"	3/8"	11,5	11	56	28	100
1/2"	1/2"	14	15	67	33,5	50

**Art.915** Raccordo a "T" F.F.M.

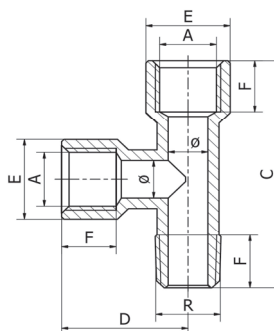
*Tee F.F.M.*

Misura	A/R	F	ø	E	C	D	gr.	
1/8"	1/8"	8	6	13	39,5	21	26	100
1/4"	1/4"	11	8	17	49	25,5	51	100
3/8"	3/8"	11,5	11	21	54	28	75	100
1/2"	1/2"	14	15	26	64,5	33,5	130	50

**Art.915/L** Modello leggero  
*Light model*

Misura	A	F	CH	C	D	
1/8"	1/8"	8	10	35,5	18,5	100
1/4"	1/4"	11	12	45	22,5	100
3/8"	3/8"	11,5	15	51	25,5	100
1/2"	1/2"	14	19	60	30	50



**Art.920**

Raccordo a "T" M.F.M.

Tee M.F.M.

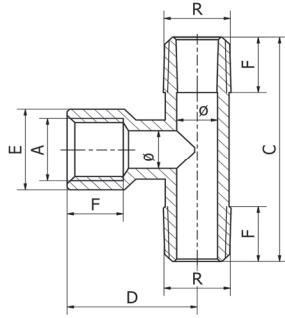
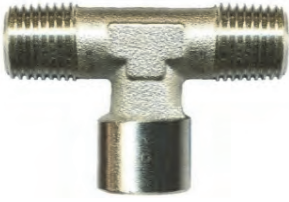

Misura	A/R	F	Ø	E	C	D	gr.	
1/8"	1/8"	8	6	13	37	21	21	100
1/4"	1/4"	11	8	17	47	25,5	45	100
3/8"	3/8"	11,5	11	21	52	28	65	100
1/2"	1/2"	14	15	26	62	33,5	111	50

**Art.920/L**

Modello leggero  
Light model

Misura	A	F	CH	C	D	gr.	
1/8"	1/8"	8	10	34	18,5	100	
1/4"	1/4"	11	12	45	22,5	100	
3/8"	3/8"	11,5	15	51	25,5	100	
1/2"	1/2"	14	19	60	30	50	

**Art.925**

Raccordo a "T" M.M.M.

Tee M.M.M.

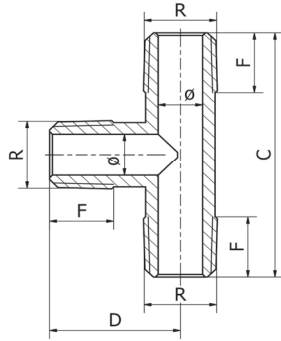

Misura	A/R	F	Ø	E	C	D	gr.	
1/8"	1/8"	8	6	13	37	18,5	17	100
1/4"	1/4"	11	8	17	47	23,5	38	100
3/8"	3/8"	11,5	11	21	52	26	56	100
1/2"	1/2"	14	15	26	62	31	94	50

**Art.925/L**

Modello leggero  
Light model

Misura	A	F	CH	C	D	gr.	
1/8"	1/8"	8	10	34	17	100	
1/4"	1/4"	11	12	45	22,5	100	
3/8"	3/8"	11,5	15	51	25,5	100	
1/2"	1/2"	14	19	60	30	50	

**Art.930**

Raccordo a "L" F.F.

Elbow F.F.

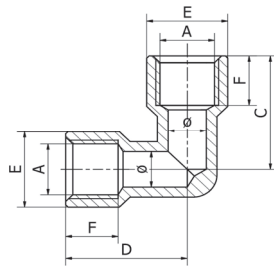

Misura	A	F	Ø	E	C	D	gr.	
1/8"	1/8"	8	6	13	21	21	20	100
1/4"	1/4"	11	8	17	25,5	25,5	40	100
3/8"	3/8"	11,5	11	21	28	28	60	100
1/2"	1/2"	14	15	26	33,5	33,5	106	50

**Art.930/L**

Modello leggero  
Light model

Misura	A	F	CH	C	D	gr.	
1/8"	1/8"	8	10	18,5	18,5	100	
1/4"	1/4"	11	12	22,5	22,5	100	
3/8"	3/8"	11,5	15	25,5	25,5	100	
1/2"	1/2"	14	19	30	30	50	

**Art.935**

Raccordo a "L" F.M.

Elbow F.M.

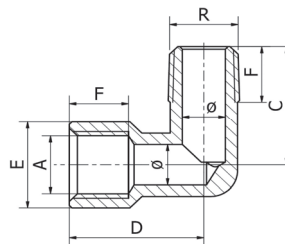

Misura	A	F	Ø	E	C	D	gr.	
1/8"	1/8"	8	6	13	21	18,5	17	100
1/4"	1/4"	11	8	17	25,5	23,5	35	100
3/8"	3/8"	11,5	11	21	28	21,5	51	100
1/2"	1/2"	14	15	26	33,5	26	87	50

**Art.935/L**

Modello leggero  
Light model

Misura	A	F	CH	C	D	gr.	
1/8"	1/8"	8	10	17	18,5	100	
1/4"	1/4"	11	12	22,5	22,5	100	
3/8"	3/8"	11,5	15	25,5	25,5	100	
1/2"	1/2"	14	19	30	30	50	

**Art.940**

Raccordo a "L" M.M.

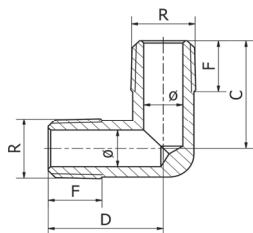
*Elbow M.M.*

Misura	A	F	ø	E	C	D	gr.	
1/8"	1/8"	8	6	13	18,5	18,5	13	100
1/4"	1/4"	11	8	17	23,5	23,5	27	100
3/8"	3/8"	11,5	11	21	21,5	21,5	40	100
1/2"	1/2"	14	15	26	26	26	71	50

**Art.940/L**

 Modello leggero  
*Light model*

Misura	A	F	CH	C	D	gr.	
1/8"	1/8"	8	10	17	17	100	
1/4"	1/4"	11	12	22,5	22,5	100	
3/8"	3/8"	11,5	15	25,5	25,5	100	
1/2"	1/2"	14	19	30	30	50	

**Art.945**

Croce F.F.F.F

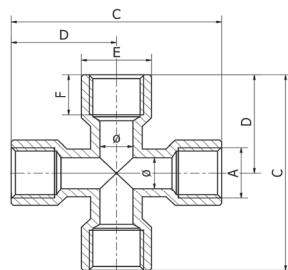
*Cross F.F.F.F.*

Misura	A	F	ø	E	C	D	gr.	
1/8"	1/8"	8	6	13	42	21	40	100
1/4"	1/4"	11	8	17	51	25,5	74	100
3/8"	3/8"	11,5	11	21	56	28	108	100
1/2"	1/2"	14	15	26	67	33,5	189	50

**Art.950**

Croce M.F.F.F

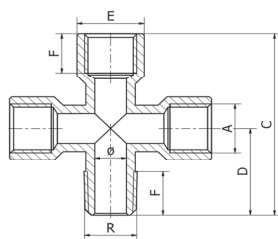
*Cross M.F.F.F.*

Misura	A	F	ø	E	C	D	gr.	
1/8"	1/8"	8	6	13	39,5	18,5	33	100
1/4"	1/4"	11	8	17	49	23,5	67	100
3/8"	3/8"	11,5	11	21	54	26	100	100
1/2"	1/2"	14	15	26	64,5	31	168	50

**Art.955**

Raccordo a "Y" M.F.F

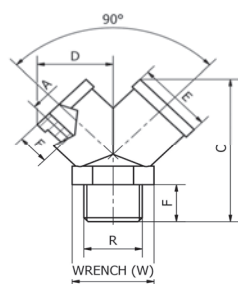
*"Y" connector M.F.F.*

Misura	A	R	W	C	D	F	gr.	
1/8"	1/8"	1/8"	13	32	14,5	8	22	100
1/4"	1/4"	1/4"	17	38	18	11	38	100
3/8"	3/8"	3/8"	20	42,5	20,5	11,5	53	100
1/2"	1/2"	1/2"	25	53	26,5	14	102	50

**Art.960**

Raccordo a "Y" F.F.F

"Y" connector F.F.F.

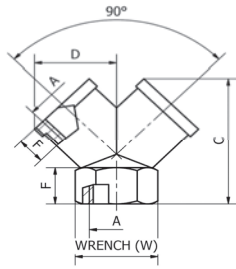

Misura	A	R	W	C	D	F	gr.	
1/8"	1/8"	1/8"	13	26,5	14,5	8	19	100
1/4"	1/4"	1/4"	17	32	18	11	34	100
3/8"	3/8"	3/8"	20	37	20,5	11,5	45	100
1/2"	1/2"	1/2"	25	45	26,5	14	89	50

**Art.965**

Prolunga

Extension

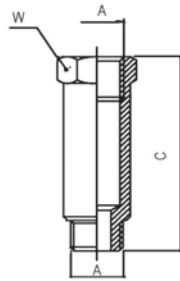

Misura	A	C	W	gr.	
1/8" x 22	1/8"	22	14	100	
1/8" x 42	1/8"	42	14	100	
1/8" x 51	1/8"	51	14	100	
1/4" x 35	1/4"	35	17	32	100
1/4" x 51	1/4"	51	17	47	100

**Art.970**

Raccordo diritto maschio conico

Straight conical push-in fitting male

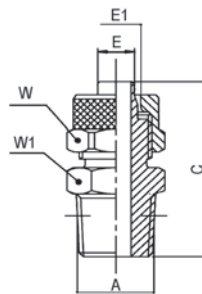

Disponibile anche F. --> Art.974  
Available also F. --> Art.974

Misura	A	W	W1	C	E1	E	gr.	
1/8" x 5/3	1/8"	12	8	25	5	3	9	100
1/8" x 6/4	1/8"	12	12	27,5	6	4	15	100
1/8" x 8/6	1/8"	12	14	27,5	8	6	18	100
1/8" x 10/8	1/8"	14	16	29,5	10	8	20	100
1/4" x 6/4	1/4"	14	12	31	6	4	21	100
1/4" x 8/6	1/4"	14	14	31	8	6	24	100
1/4" x 10/8	1/4"	17	16	32,5	10	8	27	100
3/8" x 6/4	3/8"	14	12	31,5	6	4	27	100
3/8" x 8/6	3/8"	14	14	31,5	8	6	29	100
3/8" x 10/8	3/8"	17	16	33	10	8	33	100
3/8" x 12/10	3/8"	22	18	34,5	12	10	38	100
1/2" x 15/12,5	1/2"	17	18	37,5	15	12,5	50	100

**Art.975**

Raccordo a "L" maschio conico

90° elbow conic push-in fitting male

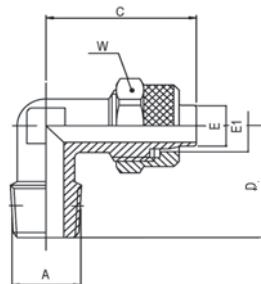

Disponibile anche F. --> Art.979  
Available also F. --> Art.979

Misura	A	W	W1	E1/E	C	D	gr.	
1/8" x 5/3	1/8"	8	8	5/3	21,5	17	11	100
1/8" x 6/4	1/8"	8	12	6/4	22,5	17	16	100
1/8" x 8/6	1/8"	10	14	8/6	22,5	17	20	100
1/8" x 10/8	1/8"	11	16	10/8	25,5	18,5	21	100
1/4" x 6/4	1/4"	10	12	6/4	22,5	20	22	100
1/4" x 8/6	1/4"	10	14	8/6	22,5	20	23	100
1/4" x 10/8	1/4"	11	16	10/8	25,5	21,5	27	100
3/8" x 6/4	3/8"	11	12	6/4	23,5	22,5	27	100
3/8" x 8/6	3/8"	11	14	8/6	24	22,5	29	100
3/8" x 10/8	3/8"	11	16	10/8	25,5	22,5	33	100
3/8" x 12/10	3/8"	14	18	12/10	30	24,5	38	100
1/2" x 15/12,5	1/2"	17	18	15/12,5	30,5	28	50	100

**Art.980**    Raccordo a "T" centrale

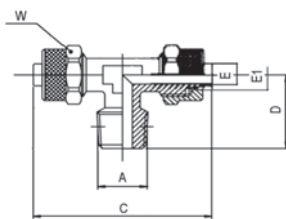
*Tee push-in fitting male*

Misura	A	W	W1	E1/E	C	D	gr.	
1/8" x 5/3	1/8"	8	8	5/3	43	17	100	
1/8" x 6/4	1/8"	8	12	6/4	45	17	26	100
1/8" x 8/6	1/8"	10	14	8/6	45,5	17,5	34	100
1/8" x 10/8	1/8"	11	16	10/8	51	18,5		100
1/4" x 6/4	1/4"	10	12	6/4	45,5	20,5	35	100
1/4" x 8/6	1/4"	10	14	8/6	45,5	20,5	38	100
1/4" x 10/8	1/4"	11	16	10/8	51	21,5		100
3/8" x 6/4	3/8"	11	12	6/4	47	22,5		100
3/8" x 8/6	3/8"	11	14	8/6	48	22,5	45	100
3/8" x 10/8	3/8"	11	16	10/8	51	22,5		100
3/8" x 12/10	3/8"	14	18	12/10	60	24,5		100
1/2"x15/12,5	1/2"	17	18	15/12,5	61	28	86	50

**Art.985**    Raccordo a "T" laterale

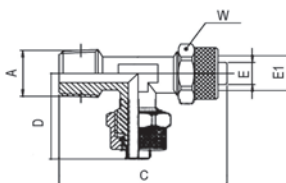
*Tee push-in fitting male*

Misura	A	W	W1	E1/E	C	D	gr.	
1/8" x 5/3	1/8"	8	8	5/3	38,5	17	100	
1/8" x 6/4	1/8"	8	12	6/4	39,5	17	26	100
1/8" x 8/6	1/8"	10	14	8/6	40,5	17,5	33	100
1/8" x 10/8	1/8"	11	16	10/8	44	18,5		100
1/4" x 6/4	1/4"	10	12	6/4	42,5	20,5		100
1/4" x 8/6	1/4"	10	14	8/6	43,5	20,5		100
1/4" x 10/8	1/4"	11	16	10/8	46,5	21,5		100
3/8" x 6/4	3/8"	11	12	6/4	46,5	22,5		100
3/8" x 8/6	3/8"	11	14	8/6	46,5	22,5		100
3/8" x 10/8	3/8"	11	16	10/8	48	22,5		100
3/8" x 12/10	3/8"	14	18	12/10	54,5	24,5		100
1/2"x15/12,5	1/2"	17	18	15/12,5	58,5	28		50

**Art.990**    Raccordo a "T" intermedio

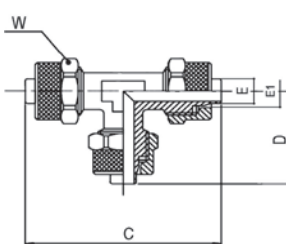
*Tee push-in fitting*

Misura	E1	E	W	C	D	gr.	
ø 5/3	5	3	8	43	21,5	100	
ø 6/4	6	4	8	45	22,5	32	100
ø 8/6	8	6	10	45	22,5	43	100
ø 10/8	10	8	11	51	25,5	56	100
ø 12/10	12	10	14	60	30		50

**Art.1100**    Portagomma maschio cilindrico

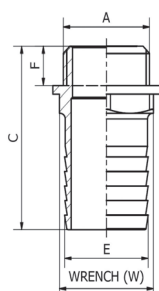
*Male hose connector*

Disponibile anche con OR  
Available also with OR  
**Art.1100/OR**

Misura	A	F	W	E	C	gr.	
1/8" x 6	1/8"	6	12	6	29,5	8	100
1/8" x 8	1/8"	6	12	8	29,5	9	100
1/8" x 10	1/8"	6	12	10	30,5		100
1/4" x 6	1/4"	8	14	6	32	13	100
1/4" x 8	1/4"	8	14	8	32	15	100
1/4" x 10	1/4"	8	14	10	33		100
1/4" x 12	1/4"	8	14	12	33	23	100
3/8" x 8	3/8"	9	19	8	33	20	100
3/8" x 10	3/8"	9	19	10	34	23	100
3/8" x 12	3/8"	9	19	12	34	23	100
3/8" x 14	3/8"	9	19	14	36	23	100
1/2" x 12	1/2"	10	22	12	35,5	23	100
1/2" x 14	1/2"	10	22	14	37,5	41	100

**Art.1105** Niplo conico

*Conical nipple*

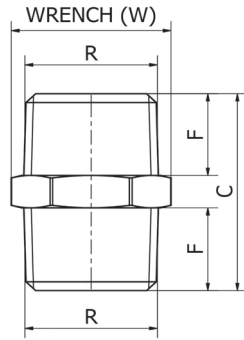

Misura	R	F	W	C	gr.	
1/8"	1/8"	8	12	20,5	9	100
1/4"	1/4"	11	14	27	17	100
3/8"	3/8"	11,5	17	28	26	100
1/2"	1/2"	14	22	33,5	45	50

**Art.1106** Niplo ridotto conico

*Reduced conic nipple*

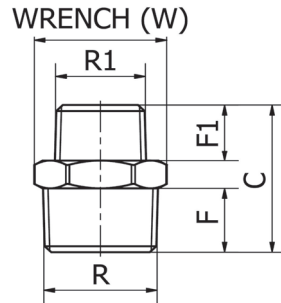

Misura	R	R1	F	F1	W	C	gr.	
1/8" x 1/4"	1/4"	1/8"	8	11	14	24	15	100
1/8" x 3/8"	3/8"	1/8"	8	11,5	17	24,5	20	100
1/4" x 3/8"	3/8"	1/4"	11	14	17	27,5	23	100
1/4" x 1/2"	1/2"	1/4"	11	14	22	30,5	37	100
3/8" x 1/2"	1/2"	3/8"	11,5	16,5	22	31	39	100
1/2" x 3/4"	3/4"	1/2"	14	16,5	27	37	69	50
3/4" x 1"	1"	3/4"	16,5	19	34	42,5	99	50

**Art.1110** Manicotto

*Socket-joint*

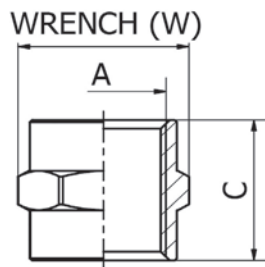

Misura	A	W	C	gr.	
1/8"	1/8"	14	15	10	100
1/4"	1/4"	17	22	20	100
3/8"	3/8"	22	23	34	100
1/2"	1/2"	26	28	79	50
3/4"	3/4"	32	32	99	50

**Art.1115** Manicotto riduzione

*Reduced socket-joint*

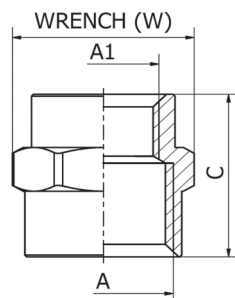

Misura	A	A1	W	C	gr.	
1/8" x 1/4"	1/4"	1/8"	17	19	17	100
1/8" x 3/8"	3/8"	1/8"	22	20	31	100
1/8" x 1/2"	1/2"	1/8"	24	24	33	100
1/4" x 3/8"	3/8"	1/4"	22	22,5		100
1/4" x 1/2"	1/2"	1/4"	24	26		100
3/8" x 1/2"	1/2"	3/8"	24	26		50
1/2" x 3/4"	3/4"	1/2"	32	30		50

**Art.1120** Riduzione M.F.

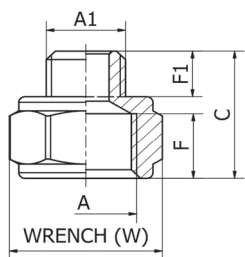
*Reduction M.F.*

Misura	A	A1	F	F1	W	C	gr.	
1/8" x 1/8"	1/8"	1/8"	8	8	14	16	10	100
1/8" x 1/4"	1/4"	1/8"	11	11	17	19,5	17	100
1/8" x 3/8"	3/8"	1/8"	11,5	11,5	22	20,5	30	100
1/4" x 1/4"	1/4"	1/4"	11	11	17	21,5	19	100
1/4" x 3/8"	3/8"	1/4"	11,5	11,5	22	22,5	32	100
1/4" x 1/2"	1/2"	1/4"	14	14	24	26	36	100
3/8" x 3/8"	3/8"	3/8"	11,5	11,5	22	23,5	35	100
3/8" x 1/2"	1/2"	3/8"	14	14	24	27	39	100
1/2" x 1/2"	1/2"	1/2"	14	14	26	28	54	50

**Art.1130** Tappo con brugola con OR

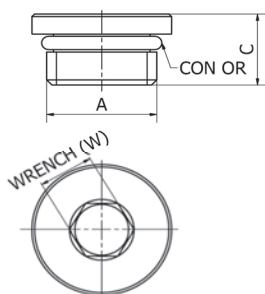
*Male plug with OR*

Misura	A	W	C	gr.	
1/8"	1/8"	5	9,5	6	100
1/4"	1/4"	6	11,5	12	100
3/8"	3/8"	8	12,5	18	100
1/2"	1/2"	10	14	33	50

**Art.1135** Tappo maschio a scomparsa fil conico

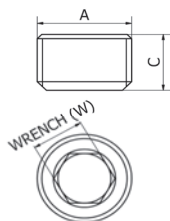
*Male plug conic thread*

Misura	A	W	C	gr.	
1/8"	1/8"	5	7,5	3	100
1/4"	1/4"	6	10	8	100
3/8"	3/8"	8	11	14	100
1/2"	1/2"	10	13	25	50

**Art.1136** Tappo maschio a scomparsa fil cilindri

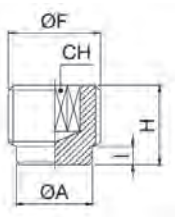
*Male plug cylindrical thread*

Misura	A	I	H	CH	gr.	
1/8"	7,5	2	8	5	3	100
1/4"	10	3	10	6	8	100
3/8"	13	3,5	12	8	14	100
1/2"	16	4	14	10	25	50

**Art.1140** Silenziatore rete

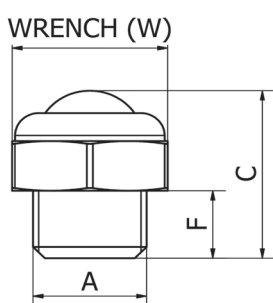
*Silencer of steel wire conic thread*

Misura	A	F	W	C	gr.	
1/8"	1/8"	6	13	15	6	100
1/4"	1/4"	7	16	18	10	100
3/8"	3/8"	8	19	20	17	100
1/2"	1/2"	10	24	22	25	50

**Art.1145** Innesto rapido maschio

*Rapid male clutch*

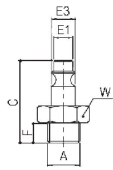

Misura	A	F	W	E	E1	
1/4"	1/4"	8,3	14	7,4	11,8	10
3/8"	3/8"	8	17	7,4	11,8	10

**Art.1145/B** Raccordo diretto attacco baionetta

*Straight male bayonet + milled nut*

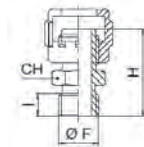

Misura	F	I	H	CH	
1/4"	1/4"	10	28,5	15	10
3/8"	3/8"	10	28,5	17	10

**Art.1146** Innesto rapido femmina

*Rapid female clutch*

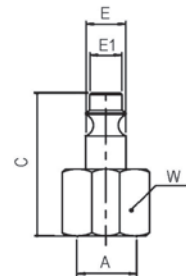

Misura	A	W	E	E1	C	
1/4"	1/4"	15	11,8	7,4	37	10
3/8"	3/8"	19	11,8	7,4	39,4	10

**Art.1148** Innesto rapido spirale

*Rapid spiral clutch*

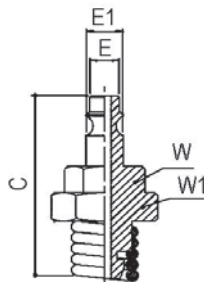

Misura	W	W1	E	E1	C	
8 x 6	13	13	7,4	11,8	127	10
10 x 8	13	15	7,4	11,8	124	10
12 x 10	15	17	7,4	11,8	130	10

**Art.1149** Innesto rapido portagomma

*Rapid hose connector clutch*

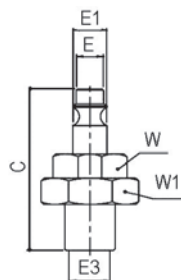

Misura	E	E1	E2	W	W1	C	
6 x 14	7,4	11,8	16,4	13	17	58,6	10
8 x 12	7,4	11,8	15	13	15	58,6	10
8 x 17	7,4	11,8	18,7	13	19	58,6	10
10 x 19	7,4	11,8	21,4	14	22	62	10

**Art.1150** Rubinetto innesto rapido maschio

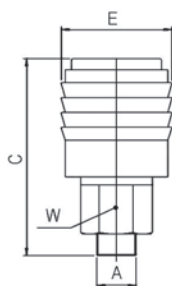
*Rapid male clutch tap*

Misura	A	W	E	C	
1/4"	1/4"	15	22,7	51,3	10
3/8"	3/8"	17	22,7	44,4	10
1/2"	1/2"	21	22,7	47	10

**Art.1155** Rubinetto innesto rapido femmina

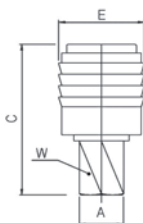
*Rapid female clutch tap*

Misura	A	W	C	
1/4"	1/4"	17	48,5	10
3/8"	3/8"	18	49,5	10

**Art.1160** Rubinetto innesto rapido portagomma

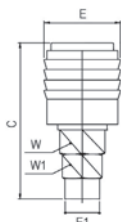
*Rapid hose connector clutch tap*

Misura	E	E1	W	W1	C	
6 x 14	16	22,7	15	17	73	10
8 x 12	15	22,7	15	15	71	10
8 x 17	18	22,7	15	19	72,5	10
10 x 19	21	22,7	15	22	73,3	10

**Art.1165** Rubinetto innesto rapido spirale

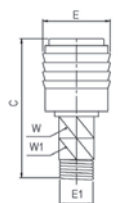
*Rapid spiral clutch tap*

Misura	E1	W	W1	C	
8 x 6	17,9	15	13	138	10
10 x 8	17,9	15	15	138	10
12 x 10	17,9	15	17	140	10

**Art.1170** Rubinetto spillo levetta

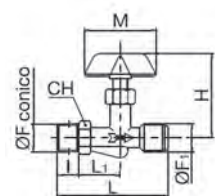
*Line tap - lever*

Misura	I	H	L	L1	CH	m	leva	
1/8"x1/4"	9	37,5	46,5	16	13	34	plastica	10
1/4"x1/4"	11	44	59,5	21	15	43	ottone	10
* 1/4"x1/4"	10,5	37,5	51	18,5	14	34	plastica	10
3/8"x1/4"	11,5	44	59,5	20,5	15	43	ottone	10
1/2"x1/4"	12,5	44	63,5	23,5	22	43	ottone	10

\*versione MIGNON



## ACCIAIO INOX AISI 316

*Stainless steel AISI 316*



### Caratteristiche tecniche

*Technical features*

Materiale utilizzato : Acciaio Inox AISI 316  
 Filettature : ISO 228 per i portagomma (Art.2145 e 2660)  
 ISO 7 per tutti gli altri prodotti

Il portagomma ( Art.2145 ) è la copia esatta dei portagomma in ottone (Art.145 ), ciò vuol dire che c'è piena compatibilità tra il diametro della resca e le misure standard dei tubi europei; inoltre l'articolo presenta una flangia di battuta che evita il trascinarsi del sigillante  
 Campi di utilizzo: nautica, alimentare e industriale  
 Fluidi compatibili : acqua, acqua di mare, soluzioni saline, carburanti ecc..

*Material used : Stainless steel AISI 316*  
*Threads : ISO 228 for hose connector*  
*ISO 7 for the other products*

*The hose connector ( Art.2145 ) is the exact copy of brass hose connector (Art.145 ), so there is full compatibility between the diameter of pipe and the tube, besides there is a ledge flange to avoid the entrainment of dope*  
*Field of use: nautical, foodstuffs and industrial*  
*Compatible fluids: water, seawater, saline solution and fuel..*

**Art.2132** Valvola di ritegno AISI 316, PN63

Check valve AISI 316, PN63

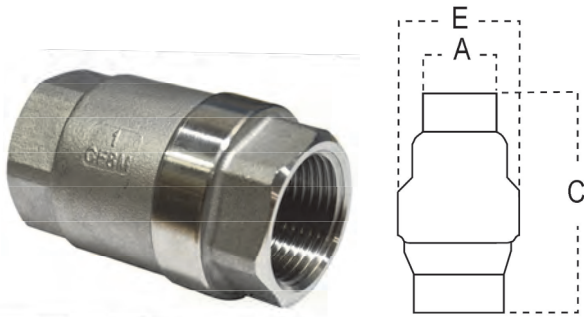

 Sede metallo  
Metal seat

 \* disponibile anche con sede VITON o PTFE, +10%  
\* available also with VITON or PTFE seat, +10%

Misura	A	E	C	
1/4"	1/4"	30,5	53	10
3/8"	3/8"	30,5	53	10
1/2"	1/2"	37	56	10
3/4"	3/4"	42	63	10
1"	1"	48	74	10
1.1/4"	1.1/4"	58	81	5
1.1/2"	1.1/2"	70	91	4
2"	2"	82	97	2
2.1/2"	2.1/2"	103	118	1
3"	3"	120	138	1
4"	4"	150	158	1

**Art.2134** Valv. di ritegno "EURO INOX" 316, PN63

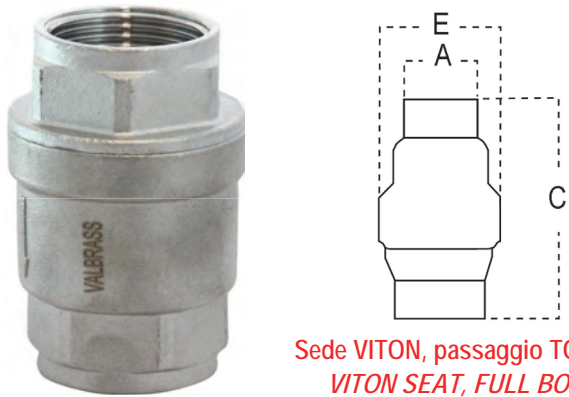
Check valve "EURO INOX", AISI 316, PN63

 Sede VITON, passaggio TOTALE  
VITON SEAT, FULL BORE

Misura	A	E	C	gr	
1/4"	1/4"	29,3	48	148	1
3/8"	3/8"	30	54	170	1
1/2"	1/2"	34,5	57	110	1
3/4"	3/4"	41,5	64	289	1
1"	1"	48	75	395	1
1.1/4"	1.1/4"	60,5	82	577	1
1.1/2"	1.1/2"	71	93	856	1
2"	2"	87	100	1287	1
2.1/2"	2.1/2"	111	120	2613	1
3"	3"	126	141	3617	1
4"	4"	155	154	6157	1

**Art.2150** Valv. di ritegno 304, sede VITON, PN16

Check valve AISI 304, VITON seat, PN16

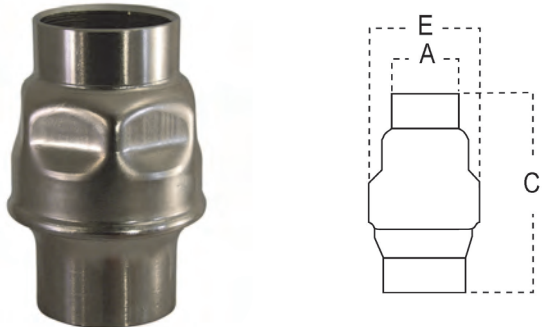
 Versione in AISI 316 su richiesta Art.2151  
Version in AISI 316 on request Art.2151

Misura	A	E	C	gr.	
1/4"	1/4"	32	55	AISI 304	94 10
3/8"	3/8"	32	55	AISI 304	91 10
1/2"	1/2"	32	55	AISI 304	93 10
3/4"	3/4"	44	70	AISI 304	129 10
1"	1"	53	84	AISI 304	191 10
1.1/4"	1.1/4"	62	99	AISI 304	281 5
1.1/2"	1.1/2"	78	119	AISI 304	388 4
2"	2"	89	123	AISI 304	704 2
2.1/2"	2.1/2"	113	147	AISI 304	1425 1
3"	3"	132	166	AISI 304	2085 1
4"	4"	167	193	AISI 304	3415 1

**Art.2152** Valv. di rit. M.F. 304, sede VITON, PN16

Check valve AISI 304, VITON seat, PN16

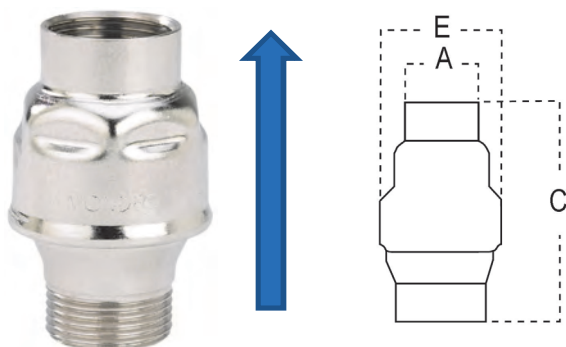

Misura	A	E	C	gr.	
1"	1"	53	84	191	10
1.1/4"	1.1/4"	62	99	281	5
1.1/2"	1.1/2"	78	119	388	4
2"	2"	89	123	704	2

 Versione in AISI 316 su richiesta  
Version in AISI 316 on request

**Art.130/NY** Valv. di rit. in NYLON 66, sede NBR, PN6 *NYLON 66 check valve, NBR seat, PN6*

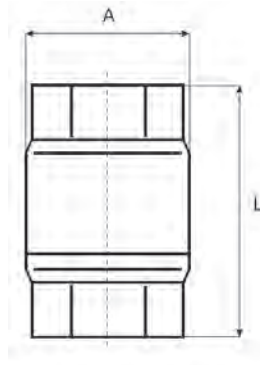

Misura	DN	A	L	gr.	
1/2"	15	40	65	80	10
3/4"	20	45	73	110	10
1"	25	54	82	160	10
1.1/4"	32	68	95	315	5
1.1/2"	40	79	104	400	4

Disponibili fino a fine scorte

**Art.2235** Filtro in AISI 304

*Filter in AISI 304*

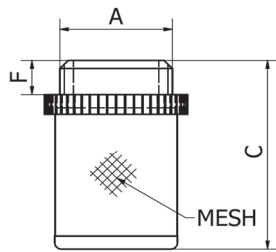

Misura	DN	C	F	gr.	
3/8"	8	55	15	12	10
1/2"	15	55	15	15	10
3/4"	20	62	15	25	10
1"	25	71	15	34	10
1.1/4"	32	80	20	52	5
1.1/2"	40	90	20	62	4
2"	50	101	20	86	1
2.1/2"	65	111	25	135	1
3"	80	125	25	168	1
4"	100	144	25	253	1

Disponibile anche in AISI 316 Art.2235/316  
Available also in AISI 316 : Art.2235/316

**Art.2145** Portagomma maschio

*Male hose connector*

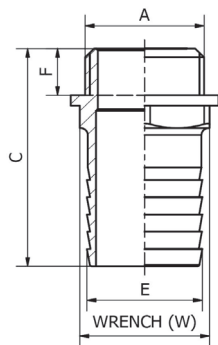

Misura	A	E	F	W	C	gr.	
1/4" x 9	1/4"	9	9	15	37	20	10
* 1/4" x 10	1/4"	10	12	15	48,5	23	10
3/8" x 12	3/8"	12	8,5	19	38	37	10
1/2" x 14	1/2"	14	9,5	18	44,5	31	10
1/2" x 16	1/2"	16	9,5	18	44,5	33	10
1/2" x 18	1/2"	18	9,5	20	47,5	42	10
1/2" x 20	1/2"	20	9,5	22	50	49	10
3/4" x 20	3/4"	20	10	23	53	55	10
3/4" x 25	3/4"	25	10	27	56	77	10
* 1" x 19	1"	19	13	28	55	89	10
1" x 20	1"	20	13	28	55	89	10
1" x 25	1"	25	13	28	58	96	10
1" x 30	1"	30	13	32	60	123	10
1.1/4" x 30	1.1/4"	30	15,5	38	69	150	5
1.1/4" x 35	1.1/4"	35	15,5	38	70	153	5
1.1/4" x 40	1.1/4"	40	15,5	42	70	156	5
1.1/2" x 40	1.1/2"	40	15,5	44	76	190	5
2" x 50	2"	50	14	52	73	255	1
2.1/2" x 60	2.1/2"	60	16	65	94	545	1
2.1/2" x 65	2.1/2"	65	18	65	97	630	1
3" x 80	3"	80	19	85	108	774	1
4" x 100	4"	100	18	105	120	1199	1

FILETTO CILINDRICO ISO 228  
CYLINDRICAL THREAD ISO 228

\* 1/4"x10 e 1"x19 filetto conico / conical thread

**Art.2245** Portagomma femmina

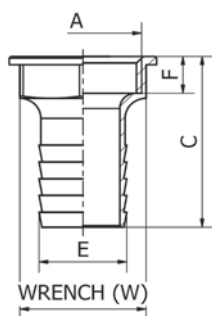
*Female hose connector*

Misura	A	E	F	W	C	gr.	
3/4" x 19	3/4"	19	20	28	45	99	10
3/4" x 25	3/4"	25	20	29	51	101	10

**Art.2293** Controdado

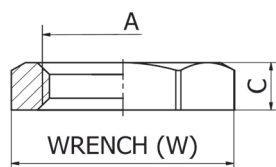
*Nut*

Misura	A	W	C	
1/4"	1/4"	22	8,5	10
3/8"	3/8"	27	9	10
1/2"	1/2"	32	9	10
3/4"	3/4"	36	10	10
1"	1"	46	11	10
1.1/4"	1.1/4"	55	12	2
1.1/2"	1.1/2"	60	13	2
2"	2"	75	13,5	2
2.1/2"	2.1/2"	95	17,5	1
3"	3"	105	21	2

**Art.2590** Raccordo a "T" F.F.F.

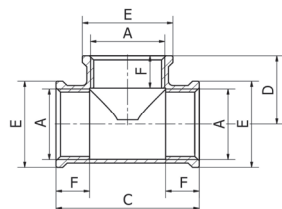
*Tee F.F.F.*

Misura	A	F	E	C	D	gr.	
1/4"	1/4"	11	17	38	19	36	10
3/8"	3/8"	11	20	46	23	47	10
1/2"	1/2"	12	27	54	27	103	10
3/4"	3/4"	13	32	63	31,5	141	10
1"	1"	16	40	71	35,5	218	10
1.1/4"	1.1/4"	17	49	84	42	314	5
1.1/2"	1.1/2"	18	56	96	48	456	4
2"	2"	17	68,5	112	55	668	2
2.1/2"	2.1/2"	24	84	130	65	1070	1
3"	3"	27	98	147	73,5	1512	1
4"	4"	36	129	188	94	3534	1

**Art.2592** Raccordo a F.F.F.F.

*F.F.F.F.*

Misura	A	F	gr.	
1/8"	1/8"	11	36	10
1/4"	1/4"	11	36	10
3/8"	3/8"	11	47	10
1/2"	1/2"	12	103	10
3/4"	3/4"	13	141	10
1"	1"	16	218	10
1.1/4"	1.1/4"	17	314	5
1.1/2"	1.1/2"	18	456	4
2"	2"	17	668	2

**Art.2593** Gomito F.F. 45°

*Elbow F.F. 45°*



Misura	A	F	gr.	
1/8"	1/8"	9	26	10
1/4"	1/4"	9	26	10
3/8"	3/8"	11	39	10
1/2"	1/2"	12	82	10
3/4"	3/4"	13	104	10
1"	1"	15	165	10
1.1/4"	1.1/4"	16	245	5
1.1/2"	1.1/2"	18	364	4
2"	2"	18	516	2
3"	3"			1

**Art.2604** Gomito M.F. 45°

*Elbow M.F. 45°*



Misura	A	F	gr.	
1/4"	1/4"	9	26	10
3/8"	3/8"	11	39	10
1/2"	1/2"	12	82	10
3/4"	3/4"	13	104	10
1"	1"	15	165	10
1.1/4"	1.1/4"	16	245	5
1.1/2"	1.1/2"	18	364	4
2"	2"	18	516	2
3"	3"			1

**Art.2595** GOMITO a 90° F.F.

*Elbow F.F.*

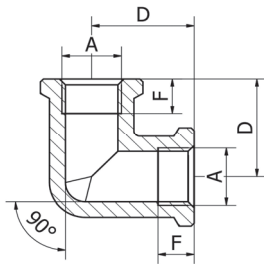

Misura	A	F	D	gr.	
1/4"	1/4"	9	18	26	10
3/8"	3/8"	11	24	39	10
1/2"	1/2"	12	27	82	10
3/4"	3/4"	13	32	104	10
1"	1"	15	36	165	10
1.1/4"	1.1/4"	16	43	245	5
1.1/2"	1.1/2"	18	47	364	4
2"	2"	18	55	516	2
2.1/2"	2.1/2"	24	68	895	1
3"	3"	27	75	1146	1
4"	4"	36	96	2755	1

**Art.2600** GOMITO a 90° M.F.

*Elbow M.F.*

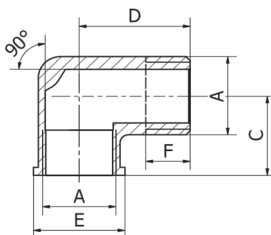

Misura	A	F	E	C	D	gr.	
1/4"	1/4"	14	17	20	30	28	10
3/8"	3/8"	14	20	25	34	45	10
1/2"	1/2"	14	27	28	37	73	10
3/4"	3/4"	16	33	33	44	118	10
1"	1"	19	40	40	52	191	10
1.1/4"	1.1/4"	20	50	44	60	285	5
1.1/2"	1.1/2"	21	56	49	65	412	4
2"	2"	24	68	55	73	570	2
2.1/2"	2.1/2"	30	85	65	89	1062	1
3"	3"	36	98	74	101	1385	1
4"	4"						1

**Art.2605** Niplo

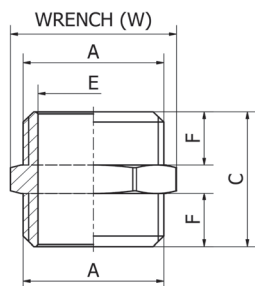
*Nipple*

Misura	A	F	W	E	C	gr.	
1/4"	1/4"	11	15	8,5	30	18	10
3/8"	3/8"	12	18	11	30	26	10
1/2"	1/2"	15	24	14	40	57	10
3/4"	3/4"	17	28	20	45	80	10
1"	1"	18	36	26	46	108	10
1.1/4"	1.1/4"	20	44	34	52	154	5
1.1/2"	1.1/2"	22	51	39	56	223	4
2"	2"	26	64	51	65	324	2
2.1/2"	2.1/2"	30	77	63	75	678	1
3"	3"	32	91	77	79	773	1
4"	4"	34	118	102	84	1115	1

**Art.2660** Niplo

*Nipple*

Misura	A	
1/4"	1/4"	10
3/8"	3/8"	10
1/2"	1/2"	10
3/4"	3/4"	10
1"	1"	10
1.1/4"	1.1/4"	5
1.1/2"	1.1/2"	4
2"	2"	2

**Art.2610** Niplo ridotto

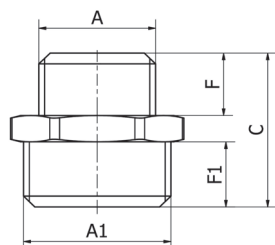
*Reduced nipple*

Misura	A	A1	F	W	C	gr.	
1/4" x 1/8"	1/8"	1/4"	9	14	28	16	10
3/8" x 1/8"	1/8"	3/8"	11	18	32	27	10
3/8" x 1/4"	1/4"	3/8"	11	18	32	27	10
1/2" x 1/8"	1/8"	1/2"	12	22	35	41	10
1/2" x 1/4"	1/4"	1/2"	12	22	35	41	10
1/2" x 3/8"	3/8"	1/2"	12	22	35	41	10
3/4" x 1/4"	1/4"	3/4"	14	28	40	63	10
3/4" x 3/8"	3/8"	3/4"	14	28	40	63	10
3/4" x 1/2"	1/2"	3/4"	14	28	40	63	10
1" x 1/2"	1/2"	1"	16	358	44	90	10
1" x 3/4"	3/4"	1"	16	358	44	90	10
1.1/4" x 1/2"	1/2"	1.1/4"	19	44	48	136	5
1.1/4" x 3/4"	3/4"	1.1/4"	21	50	53	136	4
1.1/4" x 1"	1"	1.1/4"	19	44	48	136	5
1.1/2" x 3/4"	3/4"	1.1/2"	21	50	53	196	4
1.1/2" x 1"	1"	1.1/2"	21	62	60	196	2
1.1/2" x 1.1/4"	1.1/4"	1.1/2"	21	50	53	196	4
2" x 1"	1"	2"	21	62	60	295	2
2" x 1.1/4"	1.1/4"	2"	21	62	60	295	2
2" x 1.1/2"	1.1/2"	2"	21	62	60	295	2
2.1/2" x 2"	2"	2.1/2"	27	78	63	433	1
3" x 2.1/2"	2.1/2"	3"	27	92	70	641	1
4" x 3"	3"	4"	29	118	77	1076	1

**Art.2615**

Riduzione esagono M.F.

*Bushing M.F.*

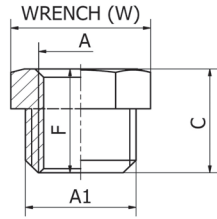

Misura	A	A1	F	W	C	gr.	
1/4" x 1/8"	1/8"	1/4"	12	17	17	12	10
3/8" x 1/8"	1/4"	1/8"	12				10
3/8" x 1/4"	1/4"	3/8"	12	21	18	18	10
1/2" x 1/8"	1/8"	1/2"					10
1/2" x 1/4"	1/4"	1/2"	12	22	22,5	31	10
1/2" x 3/8"	3/8"	1/2"	12	22	19	21	10
3/4" x 1/4"	1/4"	3/4"					10
3/4" x 3/8"	3/8"	3/4"	17	31	24	61	10
3/4" x 1/2"	1/2"	3/4"	21	31	24	54	10
1" x 1/4"	1/4"	1"					10
1" x 3/8"	3/8"	1"					10
1" x 1/2"	1/2"	1"	19	38	27	101	10
1" x 3/4"	3/4"	1"	18	38	27	84	10
1.1/4" x 1/2"	1/2"	1.1/4"	21	46	30	131	2
1.1/4" x 3/4"	3/4"	1.1/4"	21	46	30	131	2
1.1/4" x 1"	1"	1.1/4"	21	46	30	128	2
1.1/2" x 3/8"	3/8"	1.1/2"					2
1.1/2" x 1/2"	1/2"	1.1/2"					3
1.1/2" x 3/4"	3/4"	1.1/2"	23	50	32	185	2
1.1/2" x 1"	1"	1.1/2"	23	50	32	185	2
1.1/2" x 1.1/4"	1.1/4"	1.1/2"	21	53	32	157	2
2" x 1/2"	1/2"	2"					1
2" x 3/4"	3/4"	2"					2
2" x 1"	1"	2"	25	62	36	345	1
2" x 1.1/4"	1.1/4"	2"	25	62	36	304	1
2" x 1.1/2"	1.1/2"	2"	28	63	36	246	1
2.1/2" x 1.1/2"	1.1/2"	2.1/2"					1
2.1/2" x 2"	2"	2.1/2"	28	78	39	456	1
3" x 1.1/2"	1.1/2"	3"					1
3" x 2"	2"	3"	32	91	43	540	1
3" x 2.1/2"	2.1/2"	3"	32	91	43	524	1
4" x 2"	2"	4"					1
4" x 3"	3"	4"	35	118	48	1155	1

**Art.2620**

Manicotto INOX 316

*Socket AISI 316*

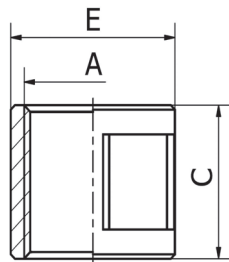

Misura	A	E	C	gr.	
1/8"	1/8"	14,3	17	13	10
1/4"	1/4"	18	25	27	10
3/8"	3/8"	21	27	33	10
1/2"	1/2"	27	34	67	10
3/4"	3/4"	32	37	84	10
1"	1"	40	44	146	10
1.1/4"	1.1/4"	49	48	201	5
1.1/2"	1.1/2"	55	48	244	4
2"	2"	67	56	367	2
2.1/2"	2.1/2"	82	65	484	1
3"	3"	95	71	676	1
4"	4"	122	83	1212	1

**Art.2621**

Mezzomanicotto INOX 316

*Socket AISI 316*

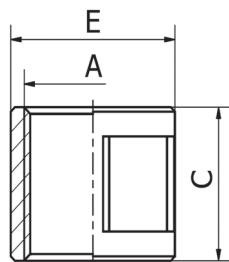

Misura	A	E	C	
1/4"	1/4"		10	10
3/8"	3/8"		12	10
1/2"	1/2"		15	10
3/4"	3/4"		15	10
1"	1"		18	10
1.1/4"	1.1/4"		20	5
1.1/2"	1.1/2"		20	4
2"	2"		25	2
2.1/2"	2.1/2"		25	1

**Art.2625** Manicotto ridotto

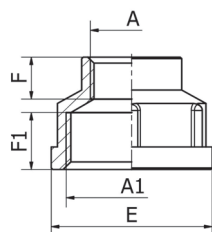
*Reduced socket*

Misura	A	A1	F	F1	C	gr.	
1/4"x1/8"	1/8"	1/4"	12	12	24	24	10
3/8" x 1/4"	3/8"	1/4"	12	12	28	24	10
1/2" x 3/8"	1/2"	3/8"	15	14	31	41	10
3/4" x 3/8"	3/4"	3/8"	18	10	36	50	10
3/4" x 1/2"	3/4"	1/2"	18	10	36	70	10
1" x 1/2"	1"	1/2"	21	12	41	104	10
1" x 3/4"	1"	3/4"	21	12	41	104	10
1.1/4" x 1"	1.1/4"	1"	20	14	45	155	5
1.1/2" x 1.1/4"	1.1/2"	1.1/4"	26	16	50	215	5
2" x 1.1/2"	1.1/2"	2"	26	17	55	305	2

Altre misure su richiesta

Other measure on request

**Art.2635** Tappo maschio

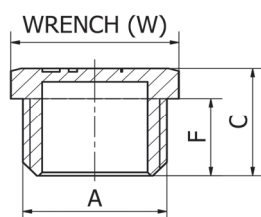
*Male plug*

Misura	A	F	W	C	gr.	
1/4"	1/4"	11	15	17	12	10
3/8"	3/8"	13	18	19	21	10
1/2"	1/2"	14	22	21	30	10
3/4"	3/4"	17	28	25	51	10
1"	1"	18	36	27	79	10
1.1/4"	1.1/4"	22	44	30	113	5
1.1/2"	1.1/2"	22	50	30	147	5
2"	2"	25	62	34	239	4
2.1/2"	2.1/2"				4	
3"	3"				2	
4"	4"				2	



Con flangia su richiesta Art.2636

With flange on request Art.2636

**Art.2637** Tappo femmina

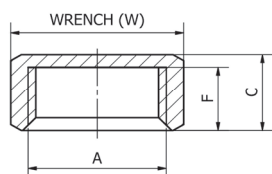
*Female plug*

Misura	A	F	W	C	gr.	
1/4"	1/4"	12	15	15	11	10
3/8"	3/8"	13	18	16	14	10
1/2"	1/2"	16	25	19	42	10
3/4"	3/4"	19	30	22	51	10
1"	1"	22	37	25	82	10
1.1/4"	1.1/4"	24	46	27	126	5
1.1/2"	1.1/2"	28	52	30	164	5
2"	2"	30		33	286	5
2.1/2"	2.1/2"	30	81	35,5	387	1
3"	3"	31,5	95	40	928	1
4"	4"				1	

**Art.2658** Tronchetto INOX 316

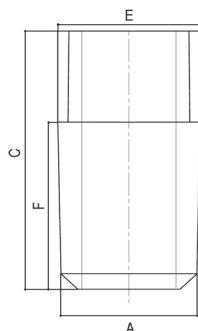
*Welding nipple AISI 316*

Misura	A	F	E	C	
1/8"	1/8"	10	10	30	5
1/4"	1/4"	12	13,5	30	5
3/8"	3/8"	12	17	30	5
1/2"	1/2"	17	21	35	5
3/4"	3/4"	19	27	40	5
1"	1"	19	33,5	40	5
1.1/4"	1.1/4"	22	42	50	1
1.1/2"	1.1/2"	22	48	50	1
2"	2"	25	60,5	50	1
2.1/2"	2.1/2"	25	76	60	1
3"	3"	30	89	70	1
4"	4"	35	114	80	1



**Art.2658/A** Tronchetto INOX 304

*Welding nipple AISI 304*

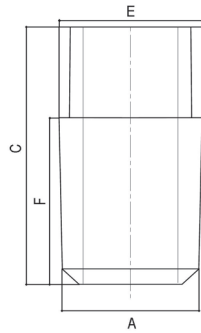

Misura	A	F	E	C	
1/8"	1/8"	10	10	30	5
1/4"	1/4"	12	13,5	30	5
3/8"	3/8"	12	17	30	5
1/2"	1/2"	17	21	35	5
3/4"	3/4"	19	27	40	5
1"	1"	19	33,5	40	5
1.1/4"	1.1/4"	22	42	50	1
1.1/2"	1.1/2"	22	48	50	1
2"	2"	25	60,5	50	1
2.1/2"	2.1/2"	25	76	60	1
3"	3"	30	89	70	1
4"	4"	35	114	80	1

**Art.2260** Bocchettone M.F. sede conica

*Union M.F. conical seat*

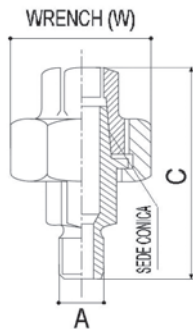

DISPONIBILE ANCHE A SEDE PIANA  
TENUTA P.T.F.E., ART.2260/F

AVAILABLE ALSO P.T.F.E. FLAT SEAT  
ART.2260/F

Misura	A	W	C	
1/8"	1/8"	15	52	5
1/4"	1/4"	15	53	5
3/8"	3/8"	15	57	5
1/2"	1/2"	15	62	5
3/4"	3/4"	16	66	5
1"	1"	18	72	5
1.1/4"	1.1/4"	21	78	1
1.1/2"	1.1/2"	22	81	1
2"	2"	25	88	1
2.1/2"	2.1/2"	25	100	1
3"	3"	29	119	1
4"	4"	34	132	1

**Art.2263** Bocchettone F.F. sede conica

*Union F.F. conical seat*

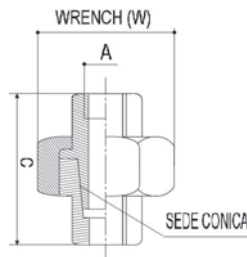

Misura	A	W	C	
1/8"	1/8"	15	37	5
1/4"	1/4"	15	37	5
3/8"	3/8"	16	39	5
1/2"	1/2"	15	41	5
3/4"	3/4"	16	42	5
1"	1"	18	51	5
1.1/4"	1.1/4"	21	52	1
1.1/2"	1.1/2"	22	56	1
2"	2"	25	60	1
2.1/2"	2.1/2"	25	75	1
3"	3"	29	89	1
4"	4"	34	99	1

**Art.2265** Bocchettone M.F. sede conica curvo

*Union M.F. conical seat*



Misura	A	
3/8"	3/8"	5
1/2"	1/2"	5
3/4"	3/4"	5
1"	1"	5
1.1/4"	1.1/4"	1
1.1/2"	1.1/2"	1
2"	2"	1

**Art.2266** Bocchettone F.F. sede conica curvo

Union F.F. conical seat



Misura	A	
3/8"	3/8"	5
1/2"	1/2"	5
3/4"	3/4"	5
1"	1"	5
1.1/4"	1.1/4"	1
1.1/2"	1.1/2"	1
2"	2"	1

**Art.2520** Filtro a Y

Y filter

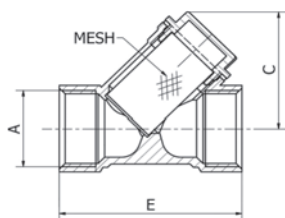

Misura	PN	A	E	C	gr.	
1/4"	40	1/4"	65	30	29	10
3/8"	40	3/8"	65	30	21	10
1/2"	40	1/2"	65	40	22	10
3/4"	40	3/4"	80	45	35	10
1"	40	1"	90	55	66	10
1.1/4"	40	1.1/4"	105	65	77	5
1.1/2"	40	1.1/2"	120	70	115	4
2"	40	2"	140	85	176	2
2.1/2"	40	2.1/2"				1
3"	40	3"				1

**Art.2170** Raccordo 5 vie

5 ways connector



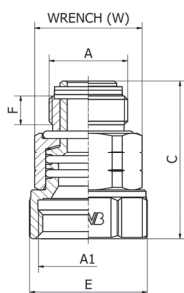

Misura	PN	A	E	C	gr.	
1" x 97	40	1/4"	65	30	29	10

**Art.2800** Raccordo GIREVOLE INOX M.F.

 Stainless Steel **SWIVEL CONNECTOR** M.F.

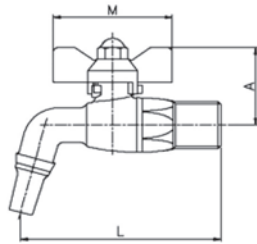

Misura	A	A1	F	W	E	C	
3/4"x1"	3/4"	1"	15	33	41	56	10
1"X1"	1"	1"	15	33	42	53	10

**Art.2330** Rubinetto a sfera curvo per botti AISI 316 *Tank bibcock AISI 316*

Misura	A	M	L	
1/2"	35	50	87	5
3/4"	48	62	108	5

**Art.2331** Rubinetto a sfera curvo per botti AISI 316 *Tank bibcock AISI 316*

CON O-RING SUL FILETTO  
WITH O-RING ON THREAD

Misura	A	M	L	
3/8"	30	48	66	5
1/2"	30	48	66	5
3/4"				1
1"				1

**Art.2331/D** Rubinetto a sfera curvo per botti AISI 316 *Tank bibcock AISI 316*

CON O-RING SUL FILETTO E CONTRODADO  
WITH O-RING ON THREAD AND LOCKNUT

Misura	A	M	L	
3/8"	30	48	66	5
1/2"	30	48	66	5
3/4"				1
1"				1

**Art.2410** Rubinetto portag. a sfera curvo *Curved ball tap with hose ring*

Misura	A	gr.	
1/2"	1/2"	237	2
3/4"	3/4"	442	2
1"	1"	606	2

INOX 316 / AISI 316

**Art.2415** Valvola a sfera F.F. INOX 316

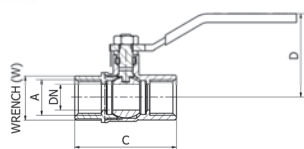
*Ball valve F.F. AISI 316*

Misura	A	DN	PN	C	D	gr.	
1/4"	1/4"	10	70	49,5	50	207	10
3/8"	3/8"	10	70	49,5	50	195	10
1/2"	1/2"	15	70	55	51,5	237	10
3/4"	3/4"	20	70	70,5	62	442	10
1"	1"	25	70	82,5	65	606	10
1.1/4"	1.1/4"	32	70	91	82	1084	2
1.1/2"	1.1/2"	40	70	103	88	1544	1
2"	2"	50	70	120	106	2648	1
2.1/2"	2.1/2"	64	70	152	119	4707	1
3"	3"	73	70	172	135	7288	1
4"	4"	92	70	190	225	11 Kg	1

Maniglia bloccabile / lock. handle

 Disponibile con filetto NPT ( vedere pag.172 )  
 Available also with NPT thread ( see pag.172 )

**Art.2421** Valvola a sfera M.F. INOX 316

*Ball valve M.F. AISI 316*

Misura	A	DN	PN	C	D	gr.	
1/4"	1/4"	10	70	44,5	50	207	10
3/8"	3/8"	10	70	44,5	50	195	10
1/2"	1/2"	15	70	55	51,5	237	10
3/4"	3/4"	20	70	70,5	62	442	10
1"	1"	25	70	82,5	65	606	5
1.1/4"	1.1/4"	32	70	91	82	1084	2
1.1/2"	1.1/2"	40	70	103	88	1544	1
2"	2"	50	70	120	106	2648	1

Maniglia bloccabile / lock. handle

**Art.2420** Valvola a sfera F.F. INOX 316

*Ball valve F.F. AISI 316*

Misura	A	DN	PN	
1/4"	1/4"	10	70	10
3/8"	3/8"	10	70	10
1/2"	1/2"	15	70	10
3/4"	3/4"	20	70	10
1"	1"	25	70	10

**Art.2422** Valvola a sfera M.F. INOX 316

*Ball valve M.F. AISI 316*

Misura	A	DN	PN	
1/4"	1/4"	10	70	10
3/8"	3/8"	10	70	10
1/2"	1/2"	15	70	10
3/4"	3/4"	20	70	10
1"	1"	25	70	10

**Art.2000**

Valvola a sfera PESANTE, att. attuatore *HEAVY ball valve F/F with actuator connection*

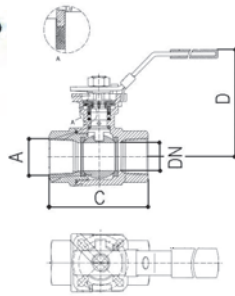

INOX 316 / AISI 316  
 Maniglia bloccabile / lock handle  
 Attacco ISO 5211 / Pad ISO 5211  
 PN 70 / 1000 PSI

Disponibile con attuatore pneumatico o elettrico / Available with electric or pneumatic actuator

Misura - A	DN	PN	C	D	Nm	gr.	
1/4"	10	70	65	73,5	4	573	2
3/8"	10	70	65	73,5	4	564	2
1/2"	15	70	65	73,5	5	583	2
3/4"	20	70	74,5	80	8	725	2
1"	25	70	88,5	95,5	12	1032	2
1.1/4"	32	70	102	100	18	1765	2
1.1/2"	40	70	110	126	22	2674	1
2"	50	70	125	134	26	3750	1
2.1/2"	64	70	161	167	50	6260	1
3"	73	70	148	176	150	9220	1
4"	90	70	220	195	250	14 kg	1

**Art.2407**

Valvola a sfera 3 Vie a L, F.F.F. *3-ways ball valve "L", F.F.F.*

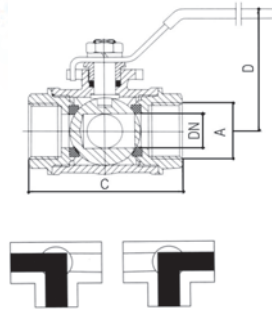

INOX 316 / AISI 316  
 Attacco per attuatore ISO 5211  
 Disponibile con attuatore pneumatico e elettrico  
 Available with electric or pneumatic actuator

Misura	A	DN	PN	C	D	
1/4"	1/4"	4,2	70	64	32	2
3/8"	3/8"	6	70	64	32	2
1/2"	1/2"	10	70	68	34	2
3/4"	3/4"	15	70	78	60	2
1"	1"	20	70	86	60	1
1.1/4"	1.1/4"	25	70	111	76	1
1.1/2"	1.1/2"	32	70	126	85	1
2"	2"	40	70	143	95	1
2.1/2"	2.1/2"					1

**Art.2408**

Valvola a sfera 3 Vie a T, F.F.F. *3-ways ball valve "T", F.F.F.*

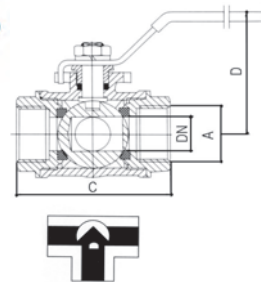

INOX 316 / AISI 316  
 Attacco per attuatore ISO 5211  
 Disponibile attuatore pneumatico e elettrico  
 Available with electric or pneumatic actuator

Misura	A	DN	PN	C	D	
1/4"	1/4"	4,2	70	64	32	2
3/8"	3/8"	6	70	64	32	2
1/2"	1/2"	10	70	68	34	2
3/4"	3/4"	15	70	78	60	2
1"	1"	20	70	86	60	1
1.1/4"	1.1/4"	25	70	111	76	1
1.1/2"	1.1/2"	32	70	126	85	1
2"	2"	40	70	143	95	1
2.1/2"	2.1/2"					1

**Art.2460**

Valvola minisfera F.F. *Ball valve "mini" F.F.*

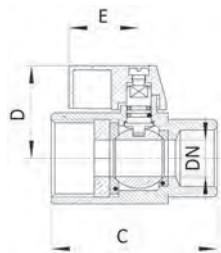

Misura - A	DN	PN	C	D	E	
1/8"	5	70	42	26,5	23	10
1/4"	7	70	42	26,5	23	10
3/8"	7	70	42	26,5	23	10
1/2"	9	70	46	28,3	23	10
3/4"	12,5	70	54	31,5	23	5
1"	15	70	65	34	23	5

Disponibile con filetto NPT ( vedere pag.172 )  
 Available also with NPT thread ( see pag.172 )

**Art.2465** Valvola minisfera M.F.

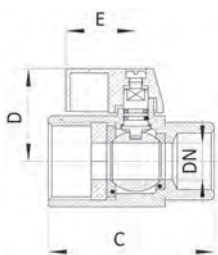
*Ball valve "mini" M.F.*

Misura - A	DN	PN	C	D	E	
1/8"	5	70	42	26,5	23	10
1/4"	7	70	42	26,5	23	10
3/8"	7	70	42	26,5	23	10
1/2"	9	70	46	28,3	23	10
3/4"	12,5	70	54	31,5	23	5
1"	15	70	65	34	23	5

Disponibile con filetto NPT ( vedere pag.172 )  
 Available also with NPT thread ( see pag.172 )

**Art.2447** Saracinesca inox F.F.

*Gate valve stainless steel, F.F.*

Misura - A	
1/2"	5
3/4"	5
1"	5
1.1/4"	2
1.1/2"	1
2"	1

**Art.2500** Valvola a spillo

*Needle valve*

**Acciaio A105, spillo inox**

**Steel A105, SS needle**

Filetto NPT su richiesta  
 NPT thread on request

Misura - A	DN	PN	C	D	E	
1/4"	7	70	42	26,5	22,8	10
3/8"	7	70	42	26,5	22,8	10
1/2"	9	70	46	28,3	22,8	10
3/4"	12,5	70	54	31,5	22,8	5
1"	15	70	65	34	22,8	5

**Disponibile anche completamente in acciaio INOX 316 ---> Art.2501 (prezzi su richiesta)**

**Available also full stainless steel AISI 316 --> Art.2501 (prices on request)**

**Art.2415/S** Valvola F.F. 1-pz

*Ball valve F.F. 1-pc*

Misura - A	
1/4"	10
3/8"	10
1/2"	10
3/4"	5
1"	5

**Art.2421/S** Valvola M.F. leva speciale

*Ball valve M.F. special handle*

Misura - A	
1/4"	1

**Art.2300**

Valvola a sfera 3 pezzi F.F.

*Ball valve 3 pieces threaded full bore F.F.*



Misura - A	
1/4"	10
3/8"	10
1/2"	10
3/4"	5
1"	5
1.1/4"	2
1.1/2"	2
2"	2
2.1/2"	1
3"	1

**Art.21250**

Colettore 2 pompe mandata AISI 304

*2 Pumps model delivery manifolds AISI 304*

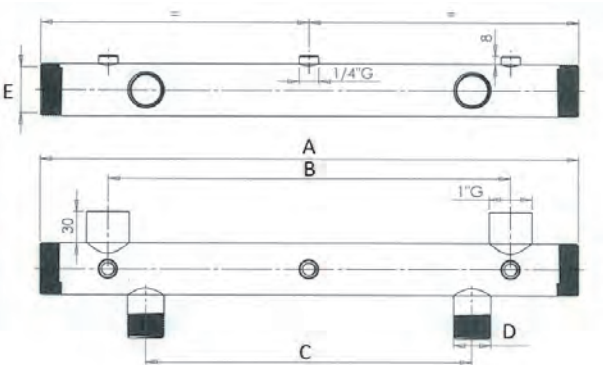

Misura - E	A	B	C	D	G	gr	
1.1/2"	500	370	300	1\"M	1/4\" F	1920	1
2"	500	370	300	1\"M	1/4\" F	2410	1
2"	500	370	300	1.1/4\"M	1/4\" F	2450	1
2"	700	370	360	1.1/4\"M	1/4\" F	3000	1
2"	500	370	300	1.1/2\"M	1/4\" F	2500	1
2"	700	390	360	1.1/2\"M	1/4\" F	3340	1
2.1/2"	500	370	300	1.1/4\"M	1/4\" F	3000	1
2.1/2"	700	390	360	1.1/4\"M	1/4\" F	3500	1
2.1/2"	500	370	300	1.1/2\"M	1/4\" F	3100	1
2.1/2"	700	390	360	1.1/2\"M	1/4\" F	6600	1
3"	700	390	360	2\"M	1/4\" F	5800	1
FLANGED DN100	700	390	360	3\"M	1/4\" F		1

**Art.21251**

Collettore 2 pompe aspirazione AISI 304

*2 Pumps model suction manifolds AISI 304*

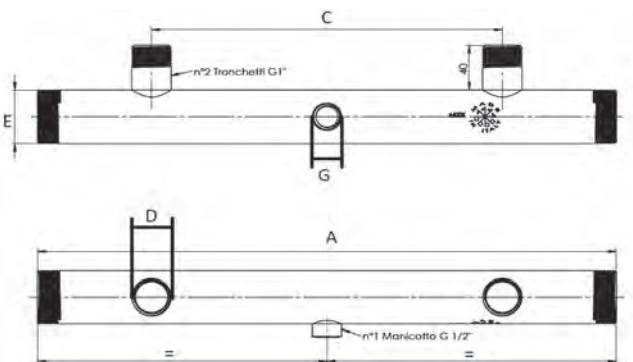
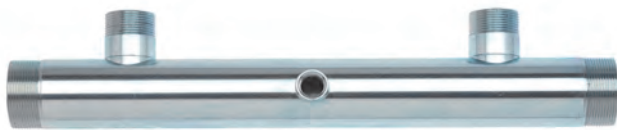

Misura - E	A	C	D	G	gr		
1.1/2"	500	300	1\"M	1/2\" F	1800	1	
2"	500	300	1\"M	1/2\" F	2200	1	
2"	500	300	1.1/4\"M	1/2\" F	2220	1	
2"	500	300	1.1/2\"M	1/2\" F	2220	1	
2"	700	360	1.1/2\"M	1/2\" F	3100	1	
2.1/2"	500	300	1.1/4\"M	1/2\" F	2800	1	
2.1/2"	700	360	1.1/4\"M	1/2\" F	3000	1	
2.1/2"	500	300	1.1/2\"M	1/2\" F	2800	1	
2.1/2"	700	360	1.1/2\"M	1/2\" F	3000	1	
3"	500	300	2\"M	1/2\" F	5200	1	
3"	700	360	2\"M	1/2\" F	6000	1	
FLANGED DN100	700	390	360	3\"M	1/4\" F		1

**Art.21252** Base per pompe e accessori

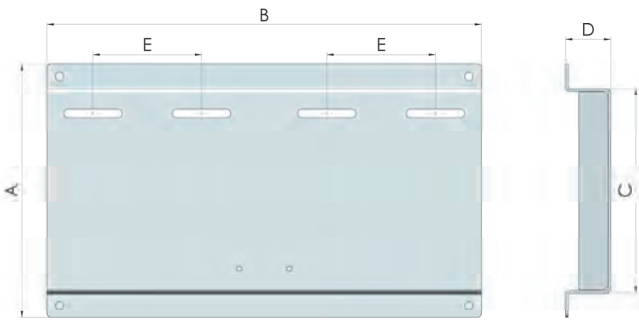
*Base plate for pumps and accessories*

Misura	A	B	C	D	E	CC	
1 pump	310	260	250	54	130	50kg	10
2 pumps	310	520	250	54	130	100kg	10
standard panel	480	90	40	100			10

**Acciaio zincato**

Altre misure su richiesta

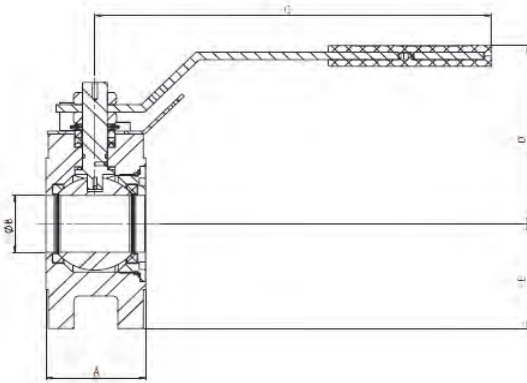
*Zinc plated steel*
*Other sizes on request*
**VALVOLE A SFERA WAFER / WAFER BALL VALVES**

**PN 16-40 / ANSI 150**

SIZE	32	40	50	65	80	100	125	150
	1 1/4"	1 1/2"	2"	2 1/2"	3"	4"	5"	6"
A	51,2	64,2	80,2	104,2	118,2	150	182	236
B	ø28	ø38	ø49	ø62	ø74	ø100	ø118	ø150
C	171	260	260	333	333	427	427	472
D	101	119	127	147,5	158	174	189	227
E	65	70	75	90	102,5	115	127,5*	165
WEIGHT KG.	4	7	9	16	22	32	45	100

 Dimensions in mm  
 \*PN40: DN125 E 135

**ANSI 300**

SIZE	1 1/4"	1 1/2"	2"	2 1/2"	3"	4"	5"	6"
A	51,2	64,2	80,2	104,2	118,2	150	182	236
B	ø28	ø38	ø49	ø62	ø74	ø100	ø118	ø150
C	171	260	260	333	333	427	427	472
D	101	119	127	147,5	158	174	189	227
E	65	70	75	90	112,5	132,5	135	165
WEIGHT KG.	4	7	9	16	22	32	45	100

Dimensions in mm

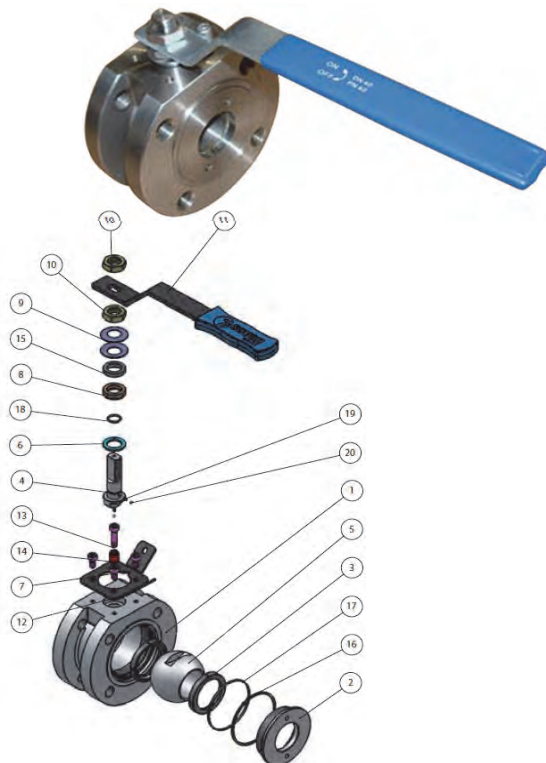

POS	DESCRIPTION	MATERIAL			SPARE PARTS (QTY)
		Art.3100	Art.3105	Art.3110	
1	BODY	WCB	CF8	CF8M	
2	CLOSURE	A105	304	316	
3	SEAT	PTFE	PTFE	PTFE	2
4	STEM	304	304	316	
5	BALL	304	304	316	ON REQUEST
6	GASKET	PTFE	PTFE	PTFE	1
7	TE SCREW	8,8	8,8	8,8	
8	CHEVRON	RPTFE	RPTFE	RPTFE	1
9	SPRING WASHER	C72	C72	C72	ON REQUEST
10	NUT	65	65	65	ON REQUEST
11	ANATOMIC LEVER	GALV. STEEL	GALV. STEEL	GALV. STEEL	ON REQUEST
12	LOCKING DEVICE	FE410	FE410	FE410	ON REQUEST
13	TE SCREW	8,8	8,8	8,8	ON REQUEST
14	LEVER STOP	FE410	FE410	FE410	ON REQUEST
15	WASHER	304	304	304	
16	GASKET	GRAPHITE	GRAPHITE	GRAPHITE	1
17	O-RING	NBR	NBR	NBR	1
18	O-RING	NBR	NBR	NBR	1
19	ANTISTATIC SPRING	304	304	316	
20	ANTISTATIC BALL	304	304	316	

DN	Art.3100	Art.3105	Art.3110
DN15			
DN20			
DN25			
DN32			
DN40			
DN50			
DN65			
DN80			
DN100			
DN125			
DN150			



**VALVOLE A SFERA CON FILETTO NPT / BALL VALVES WITH NPT THREAD**

**Art.2415/NPT**

Valvola a sfera F.F. NPT INOX 316

Ball valve F.F. NPT AISI 316

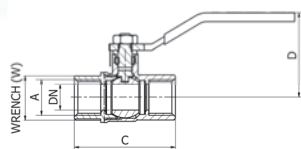

Misura	A	DN	PN	C	D	gr.	
1/4"	1/4"	10	63	49,5	50	207	10
3/8"	3/8"	10	63	49,5	50	195	10
1/2"	1/2"	15	63	55	51,5	237	10
3/4"	3/4"	20	63	70,5	62	442	10
1"	1"	25	63	82,5	65	606	10
1.1/4"	1.1/4"	32	63	91	82	1084	2
1.1/2"	1.1/2"	40	63	103	88	1544	1
2"	2"	50	63	120	106	2648	1

PN 70 / 1000 PSI  
Maniglia bloccabile / lock. handle

**Art.2460/NPT**

Valvola minisfera F.F. NPT INOX 316

Ball valve "mini" F.F. NPT AISI 316

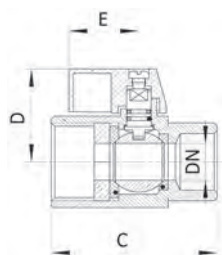

Misura - A	DN	PN	C	D	E	
1/4"	7	70	42	26,5	23	10
3/8"	7	70	42	26,5	23	10
1/2"	9	70	46	28,3	23	10
3/4"	12,5	70	54	31,5	23	5
1"	15	70	65	34	23	5

**Art.2465/NPT**

Valvola minisfera M.F. NPT INOX 316

Ball valve "mini" M.F. NPT AISI 316

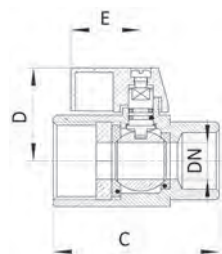

Misura - A	DN	PN	C	D	E	
1/4"	7	70	42	26,5	23	10
3/8"	7	70	42	26,5	23	10
1/2"	9	70	46	28,3	23	10
3/4"	12,5	70	54	31,5	23	5
1"	15	70	65	34	23	5

**VALVOLE A SFERA CON ATTUATORE / BALL VALVES WITH ACTUATOR**

	Misura Size	Codice Code	Con attuatore Pneumatico semplice effetto <i>With pneumatic actuator spring return</i>	Codice Code	Con attuatore Pneumatico doppio effetto <i>With pneumatic actuator double acting</i>	Codice Code	Con attuatore elettrico (12-24-220 V) <i>With electric actuator (12-24-220 V)</i>
Valvole a sfera in ottone 2 vie FF  <i>Brass ball valve 2 ways FF</i>	1/4"	415/AS		415/AD		415/E	
	3/8"						
	1/2"						
	3/4"						
	1"						
	1.1/4"						
	1.1/2"						
	2"						
	2.1/2"						
Valvole a sfera in ottone 3 vie FFF  <i>Brass ball valve 3 ways FFF</i>	1/4"	407/AS (L)		407/AD (L)		407/E (L)	
	3/8"						
	1/2"						
	1"	408/AS (T)		408/AD (T)		408/E (T)	
			1.1/4"				
			1.1/2"				
			2"				
2.1/2"							
Valvole a sfera in acciaio INOX 2 vie FF  <i>SS ball valve 2 ways FF</i>	1/4"	2000/AS		2000/AD		2000/E	
	3/8"						
	1/2"						
	3/4"						
	1"						
	1.1/4"						
	1.1/2"						
	2"						
	2.1/2"						
3"							
4"							
Valvole a sfera in acciaio INOX 3 vie FFF  <i>SS ball valve 3 ways FFF</i>	1/4"	2407/AS (L)		2407/AD (L)		2407/E (L)	
	3/8"						
	1/2"						
	1"	2408/AS (T)		2408/AD (T)		2408/E (T)	
			1.1/4"				
			1.1/2"				
			2"				
2.1/2"							



## Raccordi in ghisa malleabile

### Malleable cast iron fittings



#### Caratteristiche tecniche

#### Technical features

I raccordi sono conformi alla norma EN 10242:1994 simbolo del disegno A che specifica le caratteristiche dei raccordi in ghisa malleabile filettati. Così come prescrive la norma citata, i raccordi sono idonei per il trasporto di liquidi, aria, gas, acqua, gas combustibile, idrocarburi, ecc., secondo i limiti di pressione e temperatura elencati nella tabella A.

*The threaded malleable cast iron fittings are in compliance with Standard EN 10242:1994, design symbol A, corresponding to the materials and thread combination. In accordance with the requirements of above Standard, they are suitable for liquids, air, gas, water, burner gas, hydrocarbons, etc. under pressure and temperature limits in table A.*

- Applicazioni normali:  
Temperatura minima di servizio: -20°C  
Pressione alla temperatura minima di servizio: 25 bar  
Pressione di lavoro per temperature comprese tra -20°C e 120°C: 25 bar  
Pressione di lavoro per temperature comprese tra 120°C e 300°C: da 20 a 25 bar (valori ottenuti per interpolazione)
- Applicazioni speciali:  
Per applicazioni speciali e temperature inferiori a -20°C o altre diverse consultate il nostro ufficio tecnico.

- Standard applications:  
Minimum working temperature: -20°C  
Pressure at minimum working temperature: 25 bar  
Working pressure for temperature range from -20°C to 120°C: 25 bar  
Working pressure for temperature range from 120°C to 300°C: da 20 a 25 bar
- Special applications:  
*For special applications or temperature under -20°C or different case, we shall invite you to contact our technical service.*

Specifiche tecniche:

*Technical data*

**Tabella A - Relazione pressione/temperatura**  
*pressure/temperature*

Pressione bar / *Pressure*

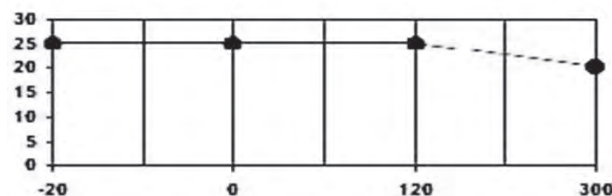

Temperatura °C / *Temperature*

I raccordi filettati sono prodotti in ghisa malleabile e disegnati secondo il simbolo del disegno specificato nella norma EN 10242:1994 come A, il cui grado di qualità è conosciuto come EN-GJMB-350-10.

*The threaded fittings are made in malleable cast iron and with design symbol A in compliance with Standard EN 10242:1994, quality grade A, known as EN-GJMB-350-10.*

Questo implica che una provetta di 12mm di diametro nominale presenta le seguenti caratteristiche meccaniche:

- Resistenza alla trazione (valore minimo) 350 N/mm<sup>2</sup>(35 Kg/mm<sup>2</sup>)
- Limite elastico 0,2% (valore minimo) 200 N/mm<sup>2</sup>(20 Kg/mm<sup>2</sup>)
- Allargamento in percentuale (valore minimo) 10%
- Durezza BRINELL (valore max) 150 HB

Fluidi compatibili : acqua, acqua di mare, soluzioni saline, carburanti ecc..

Per garantire l'assenza di difetti interni del materiale, che possono causare problemi di fuga, tutti i raccordi sono singolarmente sottoposti alla prova di tenuta per mezzo dei procedimenti indicati nella norma EN 10242:1994.

Zincatura:

Attraverso immersione in bagno di zinco fuso, secondo la norma EN 10242:1994 la copertura di zinco è superiore a 500g/m<sup>2</sup>, quindi con spessore medio minimo di 70 micron. Lo spessore dello strato di zinco e l'aderenza dello stesso con il materiale base, garantisce ai nostri raccordi in ghisa malleabile una perfetta protezione anticorrosiva nel tempo.

Pulitura ed oliatura:

Per eliminare i residui di trucioli di ferro, olio, taglio e sporcizia raccolta durante il processo di meccanizzazione, i nostri raccordi vengono puliti ed infine protetti con una vernice antiossidante.

Unione tramite filettatura:

Tipo di filetto

- Filetti di unione: i raccordi filettati in ghisa di simbolo A vengono lavorati con i filetti esterni conici ( R ) e filetti interni conici ( Rp ) conformi alla norma ISO 7/1, equivalente alle norme DIN 2999 e BS 21
- Filetti di giunzione: I raccordi in ghisa di simbolo A vengono lavorati con i filetti esterni ed interni cilindrici ( G ) conformi alla norma ISO 228/1.

Allineamento dei filetti:

Il processo di meccanizzazione dei nostri raccordi garantisce che l'allineamento dei filetti non subisca una variazione superiore a 0,5° (30'), come specificato nella norma del prodotto.

*It means that a sample test of 12mm diameter gives the following mechanical results:*

- *Tensile strenght (minimum value) 350 N/mm<sup>2</sup> (35 Kg/mm<sup>2</sup>)*
- *Elastic limit 0,2% (minimum value) 200 N/mm<sup>2</sup> (20 Kg/mm<sup>2</sup>)*
- *Percentage of enlargement (minimum value) 10%*
- *BRINELL hardness (maximum value) 150 HB*

*In order to guarantee the absence of internal material defects that might cause leak problem, every single piece is tightness tested in accordance with requirements of Standard EN 10242:1994.*

Zinc-coating:

*The fittings are galvanized by zinc plating, under Standard EN 10242:1994. The zinc coating is over 500 g/m<sup>2</sup>, that means a minimum average thickness of 70 micron. The thickness of the zinc coating and the good adherence to the base surface, assures a perfect and long-lasting anti-corrosive protection.*

Cleaning and lubrication:

*All the fittings are cleaned off from all mechanical process residuals and protected by an antioxidant paint.*

Connection by thread:

Type of threads

- *Connection threads: the fittings with design symbol A are produced with taper external thread ( R ) and parallel internal thread ( Rp ) in accordance with Standard ISO 7/1, equivalent to Standard DIN 2999 and BS 21*
- *Junction threads: the fittings with design symbol A are produced with parallel external and internal threads ( G ) in accordance with Standard ISO 228/1.*

Alignment of threads:

*The mechanization process of our fittings prevents the alignment of threads from any variations over 0.5° (30'), as specified in the Standard*

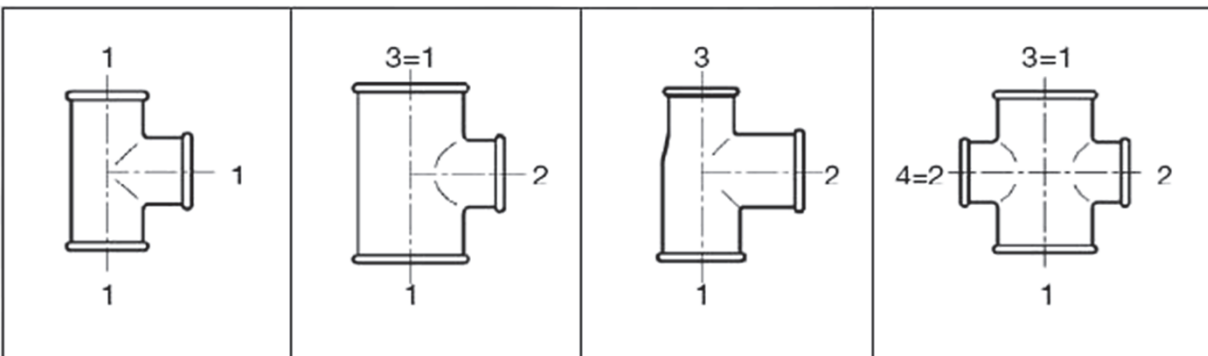

## RACCORDI IN GHISA MALLEABILE MALLEABLE CAST IRON FITTINGS

**Art.3602**

Curva a 90° M.F. ISO G4

Elbow 90° M.F. ISO G4



FIG. 1

Disponibile versione corta  
Art.3602/A (FIG 1/A).  
Prezzi -15%

Available short version.  
Art.3602/A (FIG 1/A).  
Prices -15%

Misura		
1/4"	10	300
3/8"	10	150
1/2"	10	100
3/4"	10	60
1"	10	70
1.1/4"	5	30
1.1/2"	5	24
2"	5	15
2.1/2"	1	4
3"	1	4
4"	1	2

**Art.3603**

Curva a 90° F.F. ISO G1

Elbow 90° F.F. ISO G1



FIG. 2

Disponibile versione corta  
Art.3603/A (FIG 2/A).  
Prezzi -15%

Available short version.  
Art.3603/A (FIG 2/A).  
Prices -15%

Misura		
1/4"	10	250
3/8"	10	150
1/2"	10	80
3/4"	10	60
1"	10	50
1.1/4"	5	24
1.1/2"	5	20
2"	5	10
2.1/2"	1	6
3"	1	4
4"	1	2

**Art.3604**

Curva a 90° M.M. ISO G8

Elbow 90° M.M. ISO G8



FIG. 3

Misura		
1/4"	10	10
3/8"	10	10
1/2"	10	10
3/4"	10	10
1"	10	10
1.1/4"	5	5
1.1/2"	5	5
2"	5	5
2.1/2"	1	1
3"	1	1
4"	1	1

**Art.3702** Curva a 45° M.F. ISO G4/45°

*Elbow 45° M.F. ISO G4/45°*

FIG. 40

Misura		
1/4"	10	300
3/8"	10	300
1/2"	10	150
3/4"	10	80
1"	10	100
1.1/4"	5	60
1.1/2"	5	40
2"	5	14
2.1/2"	1	8
3"	1	6
4"	1	2
6"	1	1

**Art.3703** Curva a 45° F.F. ISO G1/45°

*Elbow 45° F.F. ISO G1/45°*

FIG. 41

Misura		
3/8"	10	300
1/2"	10	150
3/4"	10	80
1"	10	80
1.1/4"	5	60
1.1/2"	5	40
2"	5	14
2.1/2"	1	8
3"	1	6
4"	1	2

**Art.3596** Curva di sorpasso f.f.

*Crossover*

FIG. 85

Misura		
1/2"	10	80
3/4"	10	40
1"	10	40
1.1/4"	5	20
1.1/2"	5	10
2"	5	5

**Art.3596/U** Curva doppia

*Return bend*

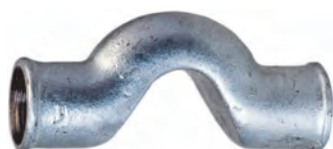
FIG. 90U

Misura		
3/4"	10	40
1"	10	40
1.1/2"	5	18
2"	5	12

**Art.3595**

Gomito a 90° F.F. ISO A1

*Elbow 90° F.F. ISO A1*



FIG. 90

Misura		
1/4"	10	10
3/8"	10	300
1/2"	10	170
3/4"	10	90
1"	10	100
1.1/4"	5	70
1.1/2"	5	50
2"	5	25
2.1/2"	1	6
3"	1	10
4"	1	4
5"	1	1
6"	1	1

**Art.3594**

Gomito ridotto a 90° F.F. ISO A1

*Reduced Elbow 90° F.F. ISO A1*



FIG. 90 R

Misura		
1/2"x3/8"	10	160
3/4"x3/8"	10	120
3/4"x1/2"	10	120
1"x1/2"	10	120
1"x3/4"	10	120
1.1/4"x1/2"	5	5
1.1/4"x3/4"	5	5
1.1/4"x1"	5	5
1.1/2"x1/2"	5	5
1.1/2"x3/4"	5	5
1.1/2"x1"	5	5
1.1/2"x1.1/4"	5	5
2"x1/2"	5	5
2"x3/4"	5	5
2"x1"	5	5
2"x1.1/4"	5	5
2"x1.1/2"	5	5
2.1/2"x1.1/2"	1	1
2.1/2"x2"	1	1
3"x1.1/2"	1	1
3"x2"	1	1
3"x2.1/2"	1	1
4"x2.1/2"	1	1
4"x3"	1	1

**Art.3600**

Gomito a 90° M.F. ISO A4

*Elbow 90° M.F. ISO A4*



FIG. 92

Misura		
1/4"	10	320
3/8"	10	260
1/2"	10	160
3/4"	10	100
1"	10	80
1.1/4"	5	50
1.1/2"	5	40
2"	5	20
2.1/2"	1	12
3"	1	10
4"	1	4

**Art.3600/R** Gomito ridotto a 90° M.F. ISO A4

*Reduced Elbow 90° M.F. ISO A4*

FIG. 92 R

Misura		
1/2"x3/8"	10	160
3/4"x3/8"	10	120
3/4"x1/2"	10	100
1"x3/4"	10	80
1.1/4"x1"	5	80
1.1/2"x1"	5	40
1.1/2"x1.1/4"	5	40

**Art.3600/M** Gomito a 90° M.M.

*Elbow 90° M.M.*

FIG. 94

Misura		
3/8"	10	10
1/2"	10	10
3/4"	10	10
1"	10	10
1.1/4"	5	5
1.1/2"	5	5
2"	5	5

**Art.3266/F** Raccordo curvo 3 pezzi F.F. ISO UA1

*3-pieces curved connector F.F. ISO UA1*

FIG. 95 D

**SEDE PIANA**
*FLAT SEAT*

Misura		
1/2"	10	10
3/4"	10	10
1"	10	10
1.1/4"	5	5
1.1/2"	5	5
2"	5	5

**Art.3266** Raccordo curvo 3 pezzi F.F. ISO UA11

*3-pieces curved connector F.F. ISO UA11*

FIG. 96

**SEDE CONICA**
*CONICAL SEAT*

Misura		
3/8"	10	10
1/2"	10	10
3/4"	10	10
1"	10	10
1.1/4"	5	5
1.1/2"	5	5
2"	5	5
2.1/2"	1	1
3"	1	1
4"	1	1

**Art.3265/F** Raccordo curvo 3 pezzi M.F. ISO UA2

*3-pieces curved connector M.F. ISO UA2*

**FIG. 97D**
**SEDE PIANA**
*FLAT SEAT*

Misura		
1/2"	10	10
3/4"	10	10
1"	10	10
1.1/4"	5	5
1.1/2"	5	5
2"	1	1



**Art.3265**

Raccordo curvo 3 pezzi M.F. ISO UA12

3-pieces curved connector M.F. ISO UA12



FIG. 98

SEDE CONICA  
CONICAL SEAT

Misura		
3/8"	10	10
1/2"	10	10
3/4"	10	10
1"	10	10
1.1/4"	5	5
1.1/2"	5	5
2"	5	5
2.1/2"	1	1
3"	1	1
4"	1	1

**Art.3705**

Gomito a 45° F.F. ISO A1/45°

Elbow 45° F.F. ISO A1/45°



FIG. 120

Misura		
1/4"	10	300
3/8"	10	200
1/2"	10	160
3/4"	10	100
1"	10	100
1.1/4"	5	60
1.1/2"	5	50
2"	5	20
2.1/2"	1	10
3"	1	8
4"	1	4

**Art.3704**

Gomito a 45° M.F. ISO A4/45°

Elbow 45° M.F. ISO A4/45°



FIG. 121

Misura		
3/8"	10	10
1/2"	10	10
3/4"	10	10
1"	10	10
1.1/4"	5	5
1.1/2"	5	5
2"	5	5
2.1/2"	5	10
3"	5	6

**Art.3590**

Raccordo a "T" F.F.F. ISO B1

Tee F.F.F. ISO B1



FIG. 130

Misura		
1/8"	10	300
1/4"	10	200
3/8"	10	140
1/2"	10	100
3/4"	10	60
1"	10	60
1.1/4"	5	36
1.1/2"	5	24
2"	5	24
2.1/2"	1	8
3"	1	8
4"	1	4
5"	1	1
6"	1	1

**Art.3591**

Raccordo a "T" ridotta F.F.F. ISO B1

*Tee F.F.F. ISO B1*

FIG. 130 R

Misura	1	2	3		
3/8"x1/4"x3/8"	3/8"	1/4"	3/8"	10	120
3/8"x1/2"x3/8"	3/8"	1/2"	3/8"	10	10
1/2"x1/4"x1/2"	1/2"	1/4"	1/2"	10	100
1/2"x3/8"x3/8"	1/2"	3/8"	3/8"	10	100
1/2"x3/8"x1/2"	1/2"	3/8"	1/2"	10	100
1/2"x1/2"x3/8"	1/2"	1/2"	3/8"	10	100
1/2"x3/4"x1/2"	1/2"	3/4"	1/2"	10	70
1/2"x1"x1/2"	1/2"	1"	1/2"	10	100
3/4"x1/4"x3/4"	3/4"	1/4"	3/4"	10	70
3/4"x3/8"x3/4"	3/4"	3/8"	3/4"	10	70
3/4"x1/2"x1/2"	3/4"	1/2"	1/2"	10	70
3/4"x1/2"x3/4"	3/4"	1/2"	3/4"	10	70
3/4"x3/4"x3/8"	3/4"	3/4"	3/8"	10	70
3/4"x3/4"x1/2"	3/4"	3/4"	1/2"	10	70
3/4"x1"x1/2"	3/4"	1"	1/2"	10	80
3/4"x1"x3/4"	3/4"	1"	3/4"	10	80
1"x1/4"x1"	1"	3/8"	1"	10	80
1"x3/8"x1"	1"	3/8"	1"	10	80
1"x1/2"x1/2"	1"	1/2"	1/2"	10	100
1"x1/2"x3/4"	1"	1/2"	3/4"	10	80
1"x1/2"x1"	1"	1/2"	1"	10	60
1"x3/4"x1/2"	1"	3/4"	1/2"	10	80
1"x3/4"x3/4"	1"	3/4"	3/4"	10	60
1"x3/4"x1"	1"	3/4"	1"	10	60
1"x1"x3/8"	1"	1"	3/8"	10	80
1"x1"x1/2"	1"	1"	1/2"	10	60
1"x1"x3/4"	1"	1"	3/4"	10	60
1"x1.1/4"x1"	1"	1.1/4"	1"	10	50
1"x1.1/2"x1"	1"	1.1/2"	1"	10	40
1.1/4"x3/8"x1.1/4"	1.1/4"	3/8"	1.1/4"	10	60
1.1/4"x1/2"x1"	1.1/4"	1/2"	1"	10	60
1.1/4"x1/2"x1.1/4"	1.1/4"	1/2"	1.1/4"	10	60
1.1/4"x3/4"x3/4"	1.1/4"	3/4"	3/4"	10	60
1.1/4"x3/4"x1"	1.1/4"	3/4"	1"	10	60
1.1/4"x3/4"x1.1/4"	1.1/4"	3/4"	1.1/4"	10	50
1.1/4"x1"x3/4"	1.1/4"	1"	3/4"	10	60
1.1/4"x1"x1"	1.1/4"	1"	1"	10	50
1.1/4"x1"x1.1/4"	1.1/4"	1"	1.1/4"	10	50
1.1/4"x1.1/4"x1/2"	1.1/4"	1.1/4"	1/2"	10	40
1.1/4"x1.1/4"x3/4"	1.1/4"	1.1/4"	3/4"	10	40
1.1/4"x1.1/4"x1"	1.1/4"	1.1/4"	1"	10	40
1.1/4"x1.1/2"x1.1/4"	1.1/4"	1.1/2"	1.1/4"	10	30
1.1/4"x2"x1.1/4"	1.1/4"	2"	1.1/4"	10	24
1.1/2"x1/2"x1.1/4"	1.1/2"	1/2"	1.1/4"	10	40
1.1/2"x1/2"x1.1/2"	1.1/2"	1/2"	1.1/2"	10	40
1.1/2"x3/4"x1.1/4"	1.1/2"	3/4"	1.1/4"	10	40
1.1/2"x3/4"x1.1/2"	1.1/2"	3/4"	1.1/2"	10	40
1.1/2"x1"x1"	1.1/2"	1"	1"	10	40
1.1/2"x1"x1.1/4"	1.1/2"	1"	1.1/4"	10	40
1.1/2"x1"x1.1/2"	1.1/2"	1"	1.1/2"	10	40
1.1/2"x1.1/4"x1"	1.1/2"	1.1/4"	1"	10	30
1.1/2"x1.1/4"x1.1/4"	1.1/2"	1.1/4"	1.1/4"	10	30
1.1/2"x1.1/4"x1.1/2"	1.1/2"	1.1/4"	1.1/2"	10	40
1.1/2"x1.1/2"x1/2"	1.1/2"	1.1/2"	1/2"	10	30
1.1/2"x1.1/2"x3/4"	1.1/2"	1.1/2"	3/4"	10	30
1.1/2"x1.1/2"x1"	1.1/2"	1.1/2"	1"	10	30
1.1/2"x1.1/2"x1.1/4"	1.1/2"	1.1/2"	1.1/4"	10	30
1.1/2"x2"x1.1/4"	1.1/2"	2"	1.1/4"	10	24
1.1/2"x2"x1.1/2"	1.1/2"	2"	1.1/2"	10	20
2"x1/2"x1.1/2"	2"	1/2"	1.1/2"	5	32
2"x1/2"x2"	2"	1/2"	2"	5	30

**Art.3591**

Raccordo a "T" ridotta F.F.F. ISO B1

Tee F.F.F. **ISO B1**



FIG. 130 R

Misura	1	2	3		
2"x3/4"x1.1/2"	2"	3/4"	1.1/2"	5	28
2"x3/4"x2"	2"	3/4"	2"	5	24
2"x1"x1.1/2"	2"	1"	1.1/2"	5	24
2"x1"x2"	2"	1"	2"	5	24
2"x1.1/4"x1.1/4"	2"	1.1/4"	1.1/4"	5	20
2"x1.1/4"x1.1/2"	2"	1.1/4"	1.1/2"	5	20
2"x1.1/4"x2"	2"	1.1/4"	2"	5	24
2"x1.1/2"x1"	2"	1.1/2"	1"	5	24
2"x1.1/2"x1.1/2"	2"	1.1/2"	1.1/2"	5	24
2"x1.1/2"x2"	2"	1.1/2"	2"	5	24
2"x2"x1/2"	2"	2"	1/2"	5	24
2"x2"x3/4"	2"	2"	3/4"	5	24
2"x2"x1"	2"	2"	1"	5	24
2"x2"x1.1/4"	2"	2"	1.1/4"	5	24
2"x2"x1.1/2"	2"	2"	1.1/2"	5	24
2.1/2"x1"x2.1/2"	2.1/2"	1"	2.1/2"	2	16
2.1/2"x1.1/4"x2.1/2"	2.1/2"	1.1/4"	2.1/2"	2	12
2.1/2"x1.1/2"x2.1/2"	2.1/2"	1.1/2"	2.1/2"	2	12
2.1/2"x2"x2"	2.1/2"	2"	2"	2	15
2.1/2"x2"x2.1/2"	2.1/2"	2"	2.1/2"	2	15
3"x1/2"x3"	3"	1/2"	3"	1	12
3"x1"x3"	3"	1"	3"	1	12
3"x1.1/4"x3"	3"	1.1/4"	3"	1	12
3"x1.1/2"x3"	3"	1.1/2"	3"	1	12
3"x2"x3"	3"	2"	3"	1	12
3"x2.1/2"x3"	3"	2.1/2"	3"	1	8
4"x1"x4"	4"	1"	4"	1	4
4"x1.1/4"x4"	4"	1.1/4"	4"	1	4
4"x1.1/2"x4"	4"	1.1/2"	4"	1	4
4"x2"x4"	4"	2"	4"	1	4
4"x2.1/2"x4"	4"	2.1/2"	4"	1	4
4"x3"x4"	4"	3"	4"	1	4

**Art.3597**

Tee con 2 curva a 90° ISO E1

Tee **ISO E1**



FIG. 131

Misura		
1/2"	10	10
3/4"	10	10
1"	10	10
1.1/4"	5	5
1.1/2"	5	5
2"	5	5

**Art.3595/D**

Tee con 2 curva a 90° ISO E2

Tee **ISO E2**



FIG. 132

Misura		
1/2"	10	10
3/4"	10	10
1"	10	10
1.1/4"	5	5
1.1/2"	5	5
2"	5	5

**Art.3593** Tee a 90° F.M.F.

*Tee F.M.F.*

FIG. 133

Misura		
3/8"	10	10
1/2"	10	10
3/4"	10	10
1"	10	10

**Art.3593/L** Tee a 90° F.F.M.

*Tee F.F.M.*

FIG. 134

Misura		
1/2"	10	10
3/4"	10	10
1"	10	10
1.1/4"	5	5
1.1/2"	5	5
2"	5	5

**Art.3590/M** Tee a 90° M.M.M.

*Tee M.M.M.*

FIG. 135

Misura		
1/2"	10	10
3/4"	10	10
1"	10	10

**Art.3590/A** Tee a 45°

*Tee 45°*

FIG. 165

Misura		
1/2"	10	10
3/4"	10	10
1"	10	10
1.1/4"	5	5
1.1/2"	5	5
2"	5	5

**Art.3592** Croce 90° ISO C1

*CROSS 90° ISO C1*

FIG. 180

Misura		
3/8"	10	10
1/2"	10	10
3/4"	10	10
1"	10	10
1.1/4"	5	5
1.1/2"	5	5
2"	5	5
2.1/2"	5	5
3"	5	5
4"	5	5

**Art.3592/R**

Croce 90° ISO C1

*CROSS 90° ISO C1*



FIG. 180 R

Misura		
1"x1/2"	10	10

**Art.3960**

Distributore a Y

*Y Distributor*



FIG. 2220

Misura		
3/8"	10	10
1/2"	10	10
3/4"	10	10
1"	10	10

**Art.3598**

Distributore 3 VIE - ISO Za1

*3 WAYS - ISO Za1*



FIG. 1221

Misura		
1/2"	10	10
3/4"	10	10
1"	10	10
1.1/4"	5	5
1.1/2"	5	5
2"	5	5

**Art.3599**

Distributore 4 VIE - ISO Za2

*4 WAYS - ISO Za2*



FIG. 1223

Misura		
1/2"	10	10
3/4"	10	10
1"	10	10
1.1/4"	5	5
1.1/2"	5	5
2"	5	5

**Art.3625**

Manicotto ridotto ISO M2

*Reduced socket ISO M2*

FIG. 240

Misura		
3/8"x1/4"	10	10
1/2"x1/4"	10	10
1/2"x3/8"	10	10
3/4"x1/4"	10	10
3/4"x3/8"	10	10
3/4"x1/2"	10	120
1"x3/8"	10	140
1"x1/2"	10	140
1"x3/4"	10	140
1.1/4"x1/2"	10	10
1.1/4"x3/4"	10	10
1.1/4"x1"	10	10
1.1/2"x1/2"	10	10
1.1/2"x3/4"	10	10
1.1/2"x1"	5	5
1.1/2"x1.1/4"	5	5
2"x1/2"	5	5
2"x3/4"	5	5
2"x1"	5	5
2"x1.1/4"	5	5
2"x1.1/2"	5	5
2.1/2"x1/2"	5	5
2.1/2"x3/4"	1	1
2.1/2"x1"	5	5
2.1/2"x1.1/4"	1	1
2.1/2"x1.1/2"	1	1
2.1/2"x2"	1	1
3"x1"	1	1
3"x1.1/4"	1	1
3"x1.1/2"	1	1
3"x2"	1	1
3"x2.1/2"	1	1
4"x1.1/2"	1	1
4"x2"	1	1
4"x2.1/2"	1	1
4"x3"	1	1

**Art.3885**

Flangia a collarino filettata F. 4 fori

*Female thread welding neck flange with 4 holes*

Misura		
1/2"	10	100
3/4"	10	60
1"	10	60
1.1/4"	5	36
1.1/2"	5	24
2"	5	24
2.1/2"	1	8
3"	1	8
4"	1	4

**Art.3615**

Riduzione esagonale M.F. ISO N4

*Bushing M.F. ISO N4*



FIG. 241

Misura		
3/8"x1/4"	10	500
1/2"x1/4"	10	450
1/2"x3/8"	10	450
3/4"x1/4"	10	250
3/4"x3/8"	10	150
3/4"x1/2"	10	250
1"x1/4"	10	180
1"x3/8"	10	180
1"x1/2"	10	180
1"x3/4"	10	180
1.1/4"x1/2"	5	180
1.1/4"x3/4"	5	180
1.1/4"x1"	5	180
1.1/2"x3/8"	5	90
1.1/2"x1/2"	5	90
1.1/2"x3/4"	5	100
1.1/2"x1"	5	110
1.1/2"x1.1/4"	5	150
2"x1/2"	5	60
2"x3/4"	5	60
2"x1"	5	60
2"x1.1/4"	5	60
2"x1.1/2"	5	60
2.1/2"x1/2"	1	36
2.1/2"x3/4"	1	36
2.1/2"x1"	1	36
2.1/2"x1.1/4"	1	36
2.1/2"x1.1/2"	1	36
2.1/2"x2"	1	36
3"x3/4"	1	24
3"x1"	1	24
3"x1.1/4"	1	24
3"x1.1/2"	1	24
3"x2"	1	24
3"x2.1/2"	1	24
4"x1"	1	16
4"x1.1/4"	1	16
4"x1.1/2"	1	16
4"x2"	1	16
4"x2.1/2"	1	16
4"x3"	1	16
5"x4"	1	1
6"x3"	1	1
6"x4"	1	1

**Art.3660**

Vite semplice

*Nipple*



FIG. 531

Misura		
3/8"	10	400
1/2"	10	400
3/4"	10	280
1"	10	160
1.1/4"	5	100
1.1/2"	5	80
2"	5	50
2.1/2"	2	24
3"	2	14

**Art.3610**

Niplo ridotto ISO N8

Reduced nipple ISO N8



FIG. 245

Misura		
3/8"x1/4"	10	360
1/2"x1/4"	10	280
1/2"x3/8"	10	280
3/4"x3/8"	10	160
3/4"x1/2"	10	160
1"x1/2"	10	120
1"x3/4"	10	140
1.1/4"x1/2"	5	100
1.1/4"x3/4"	5	100
1.1/4"x1"	5	70
1.1/2"x1/2"	5	90
1.1/2"x3/4"	5	90
1.1/2"x1"	5	90
1.1/2"x1.1/4"	5	80
2"x1/2"	5	50
2"x1"	5	50
2"x1.1/4"	5	50
2"x1.1/2"	5	50
2.1/2"x1"	1	30
2.1/2"x1.1/4"	1	30
2.1/2"x1.1/2"	1	30
2.1/2"x2"	1	30
3"x1.1/2"	1	20
3"x2"	1	20
3"x2.1/2"	1	20
4"x2"	1	10
4"x2.1/2"	1	10
4"x3"	1	10

**Art.3626**

Manicotto ridotto F.M. ISO M4

Reduced socket F.M. ISO M4



FIG. 246

Misura		
3/8"x1/4"	10	10
1/2"x1/4"	10	10
1/2"x3/8"	10	10
3/4"x3/8"	10	10
3/4"x1/2"	10	10
1"x1/2"	10	10
1"x3/4"	10	10
1.1/4"x1/2"	5	5
1.1/4"x3/4"	5	5
1.1/4"x1"	5	5
1.1/2"x3/4"	5	5
1.1/2"x1"	5	5
1.1/2"x1.1/4"	5	5
2"x1/2"	5	5
2"x3/4"	5	5
2"x1"	5	5
2"x1.1/4"	5	5
2"x1.1/2"	5	5
2.1/2"x1.1/2"	5	5
2.1/2"x2"	5	5
3"x2.1/2"	5	5



**Art.3621**

Manicotto M.F. ISO M4

Socket M.F. ISO M4



FIG. 529

Misura		
3/8"	10	10
1/2"	10	180
3/4"	10	130
1"	10	160
1.1/4"	5	100
1.1/2"	5	70
2"	5	30

**Art.3620**

Manicotto ISO M2

Socket ISO M2



FIG. 270

Misura		
1/4"	10	10
3/8"	10	250
1/2"	10	200
3/4"	10	130
1"	10	120
1.1/4"	5	100
1.1/2"	5	70
2"	5	36
2.1/2"	1	20
3"	1	14
4"	1	8
5"	1	1
6"	1	1

**Art.3622**

Manicotto destro-sinistro F.F. ISO M2 R-L Socket *right-left* F.F. ISO M2-R-L



FIG. 271

Misura		
1/2"	10	10
3/4"	10	10
1"	10	10
1.1/4"	5	5
1.1/2"	5	5
2"	5	5

**Art.3605**

Niplo ISO N8

Nipple ISO N8



FIG. 280

Misura		
1/4"	10	400
3/8"	10	360
1/2"	10	250
3/4"	10	160
1"	10	120
1.1/4"	5	100
1.1/2"	5	80
2"	5	50
2.1/2"	1	24
3"	1	16
4"	1	10
5"	1	1
6"	1	1

**Art.3606**

Vite doppia destra-sinistra ISO N8 R-L *Nipple right-left ISO N8 R-L*



FIG. 281

Misura		
3/8"	10	10
1/2"	10	10
3/4"	10	10
1"	10	10
1.1/4"	5	5
1.1/2"	5	5
2"	5	5

**Art.3635**

Tappo maschio ISO T9 *Male plug ISO T9*



FIG. 290

Misura		
1/4"	10	10
3/8"	10	550
1/2"	10	400
3/4"	10	250
1"	10	200
1.1/4"	5	140
1.1/2"	5	100
2"	5	66
2.1/2"	1	1
3"	1	1
4"	1	1

**Art.3637**

Tappo femmina esagonale ISO T1 *Hexagonal female plug ISO T1*



FIG. 300

Misura		
1/4"	10	10
3/8"	10	10
1/2"	10	300
3/4"	10	250
1"	10	10
1.1/4"	5	150
1.1/2"	5	130
2"	5	70
2.1/2"	1	40
3"	1	24
4"	1	1

**Art.3638**

Tappo femmina tondo ISO T1 *Round female plug ISO T1*



FIG. 301

Misura		
1/4"	10	10
3/8"	10	10
1/2"	10	300
3/4"	10	250
1"	10	10
1.1/4"	5	150
1.1/2"	5	130
2"	5	70
2.1/2"	1	40
3"	1	24
4"	1	1

**Art.3293**

Controdado ISO P4

*Backnut ISO P4*



FIG. 310

Misura		
1/4"	10	10
3/8"	10	10
1/2"	10	300
3/4"	10	250
1"	10	10
1.1/4"	5	150
1.1/2"	5	130
2"	5	70
2.1/2"	1	40
3"	1	24
4"	1	1

**Art.3263/F**

Raccordo diritto 3 pezzi F.F. ISO U1

*3-pieces straight connector F.F. ISO U1*



FIG. 330D SEDE PIANA *FLAT SEAT*

Misura		
3/8"	10	80
1/2"	10	80
3/4"	10	60
1"	10	60
1.1/4"	5	40
1.1/2"	5	30
2"	5	20
2.1/2"	1	10
3"	1	8
4"	1	4

**Art.3260/F**

Raccordo diritto 3 pezzi M.F. ISO U2

*3-pieces straight connector M.F. ISO U2*



FIG. 331D SEDE PIANA *FLAT SEAT*

Misura		
1/2"	10	60
3/4"	10	40
1"	10	50
1.1/4"	5	30
1.1/2"	5	24
2"	5	14
2.1/2"	1	6
3"	1	4
4"	1	2

**Art.3263**

Raccordo diritto 3 pezzi F.F. ISO U11

*3-pieces straight connector F.F. ISO U11*



FIG. 340 SEDE CONICA *CONICAL SEAT*

Misura		
1/4"	10	120
3/8"	10	120
1/2"	10	80
3/4"	10	60
1"	10	60
1.1/4"	5	40
1.1/2"	5	30
2"	5	20
2.1/2"	1	10
3"	1	8
4"	1	4

**Art.3260** | Raccordo diritto 3 pezzi M.F. ISO U12 | *3-pieces straight connector M.F. ISO U12*

**FIG. 341** SEDE CONICA  
CONICAL SEAT

Misura		
3/8"	10	10
1/2"	10	60
3/4"	10	40
1"	10	50
1.1/4"	5	30
1.1/2"	5	24
2"	5	14
2 1/2"	1	1
3"	1	1
4"	1	1

**Art.3371** | Pezzo folle M. a sede piana | *Union end M. flat seat*

**FIG. 371**

Misura		
3/8"	10	10
1/2"	10	10
3/4"	10	10
1"	10	10
1.1/4"	10	10
1.1/2"	10	10

**Art.3372** | Pezzo folle F. a sede piana | *Union end F. flat seat*

**FIG. 372**

Misura		
1/2"	10	10
3/4"	10	10
1"	10	10
1.1/4"	10	10
1.1/2"	10	10
2"	10	10

**Art.3374** | Dado | *Union nut*

**FIG. 374**

Misura	Misura Bocchettone		
1.1/8"	1/2"	10	10
1.1/4"	3/4"	10	10
1.1/2"	1"	10	10
2"	1.1/4"	10	10
2.1/4"	1.1/2"	10	10
2.3/4"	2"	10	10

**Art.3595/S** | Gomito a 90° F.F. con flangia | *Elbow 90° F.F. with flange*

**FIG. 471**

Misura		
1/2"	10	10
3/4"	10	10
1"	10	10

**Art.3620/N**

Manicotto nero

*Black socket*

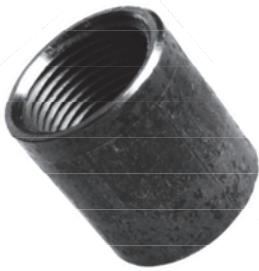

Misura	L [mm]	Ø Ext.	
1/8"	17	15	10
1/4"	25	18,5	10
3/8"	26	21,3	10
1/2"	34	25	10
3/4"	36	31,8	10
1"	43	38	10
1.1/4"	48	48,3	5
1.1/2"	48	54,5	5
2"	56	66,3	5
2.1/2"	65	82	1
3"	71	95	1
3.1/2"	80	111	1
4"	83	122	1
5"	92	147	1
6"	92	174	1

Manicotto zincato (Art.4620) : +20%

*Galvanized socket (Art.4620) : +20%*

**Art.3621/N**

Mezzo manicotto nero

*Black Half socket*



Misura	L [mm]	Ø Ext.	
1/4"	11	18,5	10
3/8"	12	21,3	10
1/2"	15	25	10
3/4"	17	31,8	10
1"	20	38	10
1.1/4"	22	48,3	5
1.1/2"	22	54,5	5
2"	26	66,3	5
2.1/2"	30	82	1
3"	33	95	1
4"	40	122	1

**Art.3595/N**

Curve amburghesi 90° a saldare

*Black elbow 90°*



Misura	DN	Ø	Sp.	
1/2"	15	21,3	2,0	10
3/4"	20	26,9	2,3	10
1"	25	33,7	2,6	10
1.1/4"	32	42,4	2,6	5
1.1/2"	40	48,3	2,6	5
2"	50	60,3	2,9	5
2.1/2"	65	76,1	2,9	1
3"	80	88,9	3,2	1
4"	100	114,3	3,6	1
5"	125	139,7	4,0	1
6"	150	168,3	4,5	1
8"	200	219,1	6,3	1
10"	250	273,0	6,3	1
12"	300	323,9	6,3	1
14"	350	355,6	6,3	1
16"	400	406,4	6,3	1

Altre misure su richiesta  
*Other sizes on request*

**Art.3637/N** Fondello bombato

Altre misure su richiesta  
Other sizes on request

*Convex bottom*

Misura	DN	Ø	Sp.	
1/2"	15	21,3	2,0	10
3/4"	20	26,9	2,3	10
1"	25	33,7	2,3	10
1.1/4"	32	42,4	2,6	10
1.1/2"	40	48,3	2,6	10
2"	50	60,3	2,9	5
2.1/2"	65	76,1	2,9	5
3"	80	88,9	3,2	5
4"	100	114,3	3,2	4
5"	125	139,7	4,0	2
6"	150	168,3	4,0	1

**Art.3590/N** Tee a saldare

Altre misure su richiesta  
Other sizes on request

*Tee*

Misura	DN	Sp.	
1/2"	15	2,0	10
3/4"	20	2,4	10
1"	25	2,6	10
1.1/4"	32	2,6	10
1.1/2"	40	2,6	10
2"	50	2,9	5
2.1/2"	65	2,9	5
3"	80	3,2	5
4"	100	3,6	4
5"	125	4,0	2
6"	150	4,5	1

**Art.3625/N** Riduzione concentrica

Altre misure su richiesta  
Other sizes on request

*Concentric reduction*

Misura	
3/4"x1/2"	10
1"x1/2"	10
1"x3/4"	10
1.1/4"x3/4"	10
1.1/4"x1"	5
1.1/2"x3/4"	5
1.1/2"x1"	5
1.1/2"x1.1/4"	1
2"x3/4"	1
2"x1"	1
2"x1.1/4"	1
2"x1.1/2"	1
2.1/2"x1"	1
2.1/2"x1.1/4"	1
2.1/2"x1.1/2"	1
2.1/2"x2"	1
3"x1.1/4"	1
3"x1.1/2"	1
3"x2"	1
3"x2.1/2"	1
4"x1.1/2"	1
4"x2"	1
4"x2.1/2"	1
4"x3"	1
5"x2"	1
5"x2.1/2"	1
5"x3"	1
5"x4"	1
6"x2.1/2"	1
6"x3"	1
6"x4"	1
6"x5"	1

Riduzioni eccentriche su richiesta

*Eccentric reductions on request*

**Art.3658/N** Tronchetti neri *Black stub ends*

L (mm)	3/8"	1/2"	3/4"	1"	1.1/4"	1.1/2"	2"	2.1/2"	3"	3.1/2"	4"
60											
70											
80											
100											
120											
150											
180											
200											
250											
300											
400											
500											
600											
700											
800											
900											
1000											
1500											
2000											
3000											



5" e 6" su richiesta / on request

**Art.3659** Barilotti zincati *Galvanized extensions*

L (mm)	3/8"	1/2"	3/4"	1"	1.1/4"	1.1/2"	2"	2.1/2"	3"	3.1/2"	4"
60											
70											
80											
100											
120											
150											
180											
200											
250											
300											
400											
500											
600											
700											
800											
900											
1000											
1500											
2000											
3000											



5" e 6" su richiesta / on request

**Barilotti SCORREVOLI : + 20 % (Art.3657)**

Art.3659/N

Barilotti neri

Black Extensions

L (mm)	3/8"	1/2"	3/4"	1"	1.1/4"	1.1/2"	2"	2.1/2"	3"	3.1/2"	4"
60											
70											
80											
100											
120											
150											
180											
200											
250											
300											
400											
500											
600											
700											
800											
900											
1000											
1500											
2000											
3000											



5" e 6" su richiesta / on request



## RACCORDI IN ACCIAIO ZINCATO

*Galvanized steel fittings*

**Art.4625**

Manicoto ridotto F.F.

*Reduced socket F.F.*



Misura	
1/4"x1/8"	10
3/8"x1/8"	10
3/8"x1/4"	10
1/2"x1/8"	10
1/2"x1/4"	10
1/2"x3/8"	10
3/4"x1/4"	5
3/4"x3/8"	5
3/4"x1/2"	5
1"x3/8"	1
1"x1/2"	1
1"x3/4"	1
1.1/4"x1"	1

**Art.4615**

Riduzione esagonale M.F.

*Reduction M.F.*



Misura	
1/4"x1/8"	10
3/8"x1/8"	10
3/8"x1/4"	10
1/2"x1/8"	10
1/2"x1/4"	10
1/2"x3/8"	10
3/4"x1/8"	10
3/4"x1/4"	10
3/4"x3/8"	10
3/4"x1/2"	10
1"x1/4"	10
1"x3/8"	10
1"x1/2"	10
1"x3/4"	10
1.1/4"x1/4"	5
1.1/4"x3/8"	5
1.1/4"x1/2"	5
1.1/4"x3/4"	5
1.1/4"x1"	5
1.1/2"x1/2"	5
1.1/2"x3/4"	5
1.1/2"x1"	5
1.1/2"x1.1/4"	5
2"x1/2"	4
2"x3/4"	4
2"x1"	4
2"x1.1/4"	4
2"x1.1/2"	4

**Art.4610** Niplo ridotto M.M.

*Nipple M.M.*

Misura	
1/4"x1/8"	10
3/8"x1/8"	10
3/8"x1/4"	10
1/2"x1/8"	10
1/2"x1/4"	10
1/2"x3/8"	10
3/4"x1/8"	10
3/4"x1/4"	10
3/4"x3/8"	10
3/4"x1/2"	10
1"x1/4"	10
1"x3/8"	10
1"x1/2"	10
1"x3/4"	10
1.1/4"x1/4"	5
1.1/4"x3/8"	5
1.1/4"x1/2"	5
1.1/4"x3/4"	5
1.1/4"x1"	5
1.1/2"x1/2"	5
1.1/2"x3/4"	5
1.1/2"x1"	5
1.1/2"x1.1/4"	5
2"x3/8"	4
2"x1/2"	4
2"x3/4"	4
2"x1"	4
2"x1.1/4"	4
2"x1.1/2"	4

**Art.4630** Prolunga ridotta F.M.

*Reduced extension F.M.*

Misura	
1/4"x1/8"	10
3/8"x1/8"	10
3/8"x1/4"	10
1/2"x1/8"	10
1/2"x1/4"	10
1/2"x3/8"	10
1/2"x3/8"x10	10
1/2"x3/8"x15	10
3/4"x3/8"	10
3/4"x1/2"	10
1"x3/8"	10
1"x1/2"	10
1"x3/4"	10
1.1/4"x1"	5

**Art.4660** Vite semplice

*Brass screw*

Misura	
1/4"	10
3/8"	10
1/2"	10
3/4"	10
1"	10
1.1/4"	10
1.1/2"	10
2"	10
2.1/2"	10
3"	10
4"	10

**Art.4605** Niplo M.M.

*Nipple M.M.*



Misura	
1/8"	10
1/4"	10
3/8"	10
1/2"	10
3/4"	10
1"	10
1.1/4"	5
1.1/2"	5
2"	2

**Art.4635** Tappo esagonale M.

*Male plug*



Misura	
1/8"	10
1/4"	10
3/8"	10
1/2"	10
3/4"	10
1"	10
1.1/4"	5
1.1/2"	5
2"	2

**Art.4636** Tappo M. con quadro

*Male plug with square*





Filetto conico  
*Conical Thread*

Misura	
1/8"	10
1/4"	10
3/8"	10
1/2"	10
3/4"	10
1"	10

**Art.4637** Tappo esagonale F.

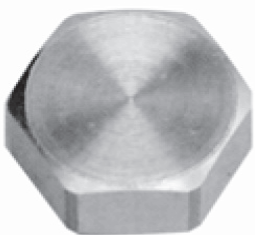
*Female plug*



Misura	
1/8"	10
1/4"	10
3/8"	10
1/2"	10
3/4"	10
1"	10
1.1/4"	5
1.1/2"	5

**Art.4293** Controdado

*Lock nut*

Misura	h	
1/8"	4	10
1/4"	5	10
3/8"	6	10
1/2"	7	10
3/4"	8	10
1"	9	10

**Art.4650** Prolunga M.F.

*Heavy extension M.F.*

Misura	
3/8"x10	10
3/8"x15	10
3/8"x20	10
3/8"x25	10
3/8"x30	10
3/8"x35	10
3/8"x40	10
3/8"x50	10
1/2"x10	10
1/2"x15	10
1/2"x20	10
1/2"x25	10
1/2"x30	10
1/2"x35	10
1/2"x40	10
1/2"x50	10
3/4"x10	10
3/4"x15	10
3/4"x20	10
3/4"x25	10
3/4"x30	10
3/4"x40	10
3/4"x50	10
1"x10	10
1"x15	10
1"x20	10
1"x25	10
1"x30	10
1"x40	10

**Art.4656** Prolunga M.F. sagomata

*Socket M.F. Octagonal Model*

Misura	
1/2"x10	10
1/2"x15	10
1/2"x20	10
1/2"x25	10
1/2"x30	10
1/2"x40	10
1/2"x50	10



Valvole Industriali  
*Industrial Valves*



## Valvole a farfalla Wafer e Lug *Butterfly valves*



### Caratteristiche tecniche *Technical features*

Adatta per impianti idrici , riscaldamento , condizionamento , antincendio e gas

Applicazioni industriali , chimiche e alimentari

Disponibili da DN 25 a DN 600

Minimo ingombro.Tenuta morbida

Adatte per regolazioni. Montaggio da effettuarsi tra due controflange

Possibilità di montaggio di attuatori elettrici, pneumatici e manuali

Sistema di lucchettaggio di serie. Non adatte per vapore.

Conforme alla direttiva 97/23/CE (PED)

Pressione da 0 a 16 bar  $\leq$  DN 300 , da 0 a 10 bar  $>$  DN 300

Temperatura : NBR da -25 a 95°C , EPDM da -35 a 120°C , Viton da -20 a 180°C , PTFE da -40 a 200°C

*For water systems , heating , conditioning , fire prevention and gas.*

*Available from DN25 to DN600*

*Small dimensions*

*Smooth seal. Suitable for regulation*

*To be mounted between both flanges*

*Possibility to install electric, pneumatic and manual actuators*

*Not suitable for steam*

*Complying with the 97/23/CE (PED) Directive*

*Pressure from 0 to 16 bar  $\leq$  DN 300 , from 0 to 10 bar  $>$  DN 300*

*Temperature : NBR from -25 to 95°C , EPDM from -35 to 120°C , Viton from -20 to 180°C , PTFE from -40 to 200°C*

**Art.3120**

Valvola tipo Lug, corpo G25, lente GS400

*Lug valve, body G25, lens GS400*

su richiesta versione gas Art.3120/G  
 on request gas version Art.3120/G

DN		
25	1"	1
32	1.1/4"	1
40	1.1/2"	1
50	2"	1
65	2.1/2"	1
80	3"	1
100	4"	1
125	5"	1
150	6"	1
200	8"	1
250	10"	1
300	12"	1

**Art.3121**

Valvola tipo Lug con lente AISI 316

*Lug valve with SS 316 lens*

disponibile anche con lente in AISI 304 : Art.3121/304L  
 available also with SS AISI 304 lens : Art.3121/304L

DN		
40	1.1/2"	1
50	2"	1
65	2.1/2"	1
80	3"	1
100	4"	1
125	5"	1
150	6"	1
200	8"	1
250	10"	1
300	12"	1
350	14"	1
400	16"	1
450	18"	1
500	20"	1

**Art.3140**

Riduttore manuale

*Gear box*

DN		
25 - 100		1
125 - 150		1
200 - 300		1
350		1
400 - 450		1
500		1

**Art.3130** Valvola tipo WAFER, corpo G25, lente GS400 *Wafer valve, body G25, lens GS400*

DN		
32	1.1/4"	1
40	1.1/2"	1
50	2"	1
65	2.1/2"	1
80	3"	1
100	4"	1
125	5"	1
150	6"	1
200	8"	1
250	10"	1
300	12"	1

**Art.3131** Valvola tipo WAFER con lente AISI 316 *Wafer valve with SS 316 lens*

DN		
40	1.1/2"	1
50	2"	1
65	2.1/2"	1
80	3"	1
100	4"	1
125	5"	1
150	6"	1
200	8"	1
250	10"	1
300	12"	1

Disponibile anche con lente in AISI 304 : Art.3131/304L  
 Available also with SS AISI 304 lens : Art.3131/304L

**Art.3122** Valvola a farfalla

*Butterfly valve*

DN		
80	3"	1

Corpo / Body : GGG40  
 Guarnizione / seal : NBR  
 Disco / Lens : GS400



**Art.3120/AS** Valvola Lug, lente GS400, attuatore SE

*Lug valve with spring return actuator*

**Attuatore semplice effetto**

DISPONIBILE CON :

LENTE AISI 316 : Art.3121/AS

LENTE AISI 304 : Art.3121/304L/AS

**Pneumatic spring return actuator**

AVAILABLE WITH :

LENS SS 316 : Art.3121/AS

LENS SS 304 : Art.3121/304L/AS

DN		
50	2"	1
65	2.1/2"	1
80	3"	1
100	4"	1
125	5"	1
150	6"	1
200	8"	1
250	10"	1
300	12"	1
350	14"	1
400	16"	1
450	18"	1
500	20"	1

**Art.3120/AD** Valvola Lug, lente GS400, attuatore DE

*Lug valve with double acting actuator*

**Attuatore doppio effetto**

DISPONIBILE CON :

LENTE AISI 316 : Art.3121/AD

LENTE AISI 304 : Art.3121/304L/AD

**Pneumatic double acting actuator**

AVAILABLE WITH :

LENS SS 316 : Art.3121/AD

LENS SS 304 : Art.3121/304L/AD

DN		
50	2"	1
65	2.1/2"	1
80	3"	1
100	4"	1
125	5"	1
150	6"	1
200	8"	1
250	10"	1
300	12"	1
350	14"	1
400	16"	1
450	18"	1
500	20"	1

**Art.3120/E** Valvola Lug, lente GS400, attuatore Elettrico

*Lug valve with electric actuator*

**Attuatore elettrico**

DISPONIBILE CON :

LENTE AISI 316 : Art.3121/E

LENTE AISI 304 : Art.3121/304L/E

**Electric actuator**

AVAILABLE WITH :

LENS SS 316 : Art.3121/E

LENS SS 304 : Art.3121/304L/E

DN		
50	2"	1
65	2.1/2"	1
80	3"	1
100	4"	1
125	5"	1
150	6"	1
200	8"	1
250	10"	1
300	12"	1
350	14"	1

**Art.3130/AS**
**Valvola Wafer, lente GS400, attuatore SE**
*Wafer valve with spring return actuator*

**Attuatore semplice effetto**

DISPONIBILE CON :

LENTE AISI 316 : Art.3131/AS

LENTE AISI 304 : Art.3131/304L/AS

**Pneumatic spring return actuator**

AVAILABLE WITH :

LENS SS 316 : Art.3131/AS

LENS SS 304 : Art.3131/304L/AS

DN		
40	1.1/2"	1
50	2"	1
65	2.1/2"	1
80	3"	1
100	4"	1
125	5"	1
150	6"	1
200	8"	1
250	10"	1
300	12"	1
350	14"	1
400	16"	1
450	18"	1
500	20"	1

**Art.3130/AD**
**Valvola Wafer, lente GS400, attuatore DE**
*Wafer valve with double acting actuator*

**Attuatore doppio effetto**

DISPONIBILE CON :

LENTE AISI 316 : Art.3131/AD

LENTE AISI 304 : Art.3131/304L/AD

**Pneumatic double acting actuator**

AVAILABLE WITH :

LENS SS 316 : Art.3131/AD

LENS SS 304 : Art.3131/304L/AD

DN		
40	1.1/2"	1
50	2"	1
65	2.1/2"	1
80	3"	1
100	4"	1
125	5"	1
150	6"	1
200	8"	1
250	10"	1
300	12"	1
350	14"	1
400	16"	1
450	18"	1
500	20"	1

**Art.3130/E**
**Valvola Wafer, lente GS400, attuat. Elettrico**
*Wafer valve with electric actuator*

**Attuatore elettrico**

DISPONIBILE CON :

LENTE AISI 316 : Art.3131/E

LENTE AISI 304 : Art.3131/304L/E

**Electric actuator**

AVAILABLE WITH :

LENS SS 316 : Art.3131/E

LENS SS 304 : Art.3131/304L/E

DN		
40	1.1/2"	1
50	2"	1
65	2.1/2"	1
80	3"	1
100	4"	1
125	5"	1
150	6"	1
200	8"	1
250	10"	1
300	12"	1
350	14"	1

## VALVOLE DI RITEGNO INDUSTRIALI CHECK VALVES

### Art.3530

Valvola di ritegno a palla filettata

*Ball check valve threaded*

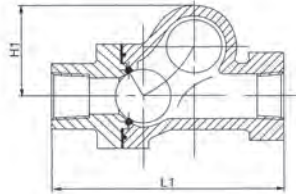

Misura	H1	L1	gr	
1"	75	125	1000	1
1.1/4"	75	132	1500	1
1.1/2"	85	145	2000	1
2"	116	174	3000	1
2.1/2"	116	200	5000	1
3"	160	243	10000	1

Pressione di esercizio : PN 16  
T. di utilizzo : -10°C + 80 °C  
Dimensioni di ingombro  
in accordo DIN 3202 F6

*Nominal pressure : PN 16  
Working temperature : -10°C + 80°C  
Face to face dimensions : DIN 3202 F6*

DISPONIBILE ANCHE IN INOX 316

AVAILABLE ALSO IN STAINLESS STEEL AISI 316

### Art.3530/F

Valvola di ritegno a palla flangiata

*Flanged ball check valve*

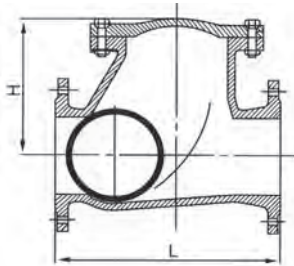

Misura	H	L	gr	
50	106	200	7500	1
65	129	240	11000	1
80	146	260	15000	1
100	194	300	21000	1
125	207	350	32000	1
150	240	400	47000	1
200	322	500	87000	1
250	388	600	140000	1
300	458	700	198000	1

Pressione di esercizio : PN 16  
T. di utilizzo : -10°C + 80 °C  
Flangiatura : PN 10 -16  
Dimensioni di ingombro  
in accordo DIN 3202 F6

*Nominal pressure : PN 16  
Working temperature : -10°C + 80°C  
Flanges holes : PN 10 - 16  
Face to face dimensions : DIN 3202 F6*

DISPONIBILE ANCHE IN INOX 316

AVAILABLE ALSO IN STAINLESS STEEL AISI 316

### Art.3531

Valvola di ritegno a molla flangiata

*Flanged spring check valve*

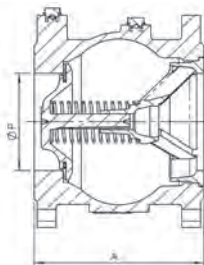

Misura	D	A	gr	
50	100	165	5200	1
65	120	185	7500	1
80	140	200	9800	1
100	170	220	12800	1
125	200	250	20000	1
150	230	285	28000	1
200	301	340	53000	1
250	370	405	70000	1
300			1	

Press. di esercizio : PN 16 fino DN150  
T. di utilizzo : -10°C + 120 °C  
Flangiatura : PN 10 -16  
Dimensioni di ingombro  
in accordo DIN 3202 F6

*Nominal pressure : PN 16 until DN150  
Working temperature : -10°C + 120°C  
Flanges holes : PN 10 - 16*

**Art.3440** Valvola di ritegno a clapet flangiata

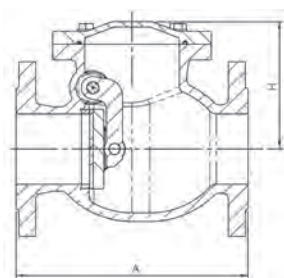
*Flanged swing check valve*

Misura	A	H	D	gr	
50	200	140	165	12000	1
65	240	142	185	16000	1
80	260	165	200	20000	1
100	300	175	220	28000	1
125	350	198	250	42000	1
150	400	228	285	58000	1
200	500	245	340	93000	1
250	600	302	395	14000	1
300	700	365	445	197000	1

Press. di esercizio : PN 16 fino DN400  
 T. di utilizzo : -10°C + 80 °C  
 Flangiatura : PN 10 -16  
 Dimensioni di ingombro  
 in accordo DIN 3202 F6

*Nominal pressure : PN 16 until DN400  
 Working temperature : -10°C + 80°C  
 Flanges holes : PN 10 - 16*

**Art.3441** Valvola di ritegno a battente in ACCIAIO

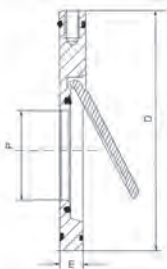
*Thin swing check valve in GALVANIZED STEEL*

Misura	D	P	E	gr	
50	109	32	14	1000	1
65	129	45	14	1200	1
80	144	56	16	1500	1
100	164	75	18	2000	1
125	194	98	18	2500	1
150	220	120	20	4000	1
200	275	164	22	7000	1
250	330	210	26	12500	1
300	380	235	28	16500	1

Pressione di esercizio : PN 16  
 fino DN150 . PN 10 oltre  
 T. di utilizzo : -10°C + 120 °C  
 Flangiatura : PN 10 -16  
 Materiale :  
 • corpo e battente : acciaio zincato  
 • guarnizione e O -Ring : EPDM

*Nominal pressure : PN 16 until DN150  
 Then PN 10  
 Working temperature : -10°C + 120°C  
 Between flanges : PN 10 - 16  
 Material :  
 • body and disc : galvanized steel  
 • gasket and O-Rings : EPDM*

**Art.3442** Valvola di ritegno a battente in INOX 316

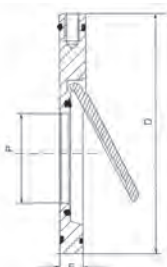
*Thin swing check valve in AISI 316*

Misura	D	P	E	gr	
50	109	32	14	1000	1
65	129	45	14	1200	1
80	144	56	16	1500	1
100	164	75	18	2000	1
125	194	98	18	2500	1
150	220	120	20	4000	1
200	275	164	22	7000	1
250	330	210	26	12500	1
300	380	235	28	16500	1

Pressione di esercizio : PN 16  
 fino DN150 . PN 10 oltre  
 T. di utilizzo : -10°C + 150 °C  
 Inseribile tra flange : PN 10 -16  
 Materiale :  
 • corpo e battente:acciaio inox 316  
 • guarnizione e O-Ring : FKM

*Nominal pressure : PN 16 until DN150  
 Then PN 10  
 Working temperature : -10°C + 150°C  
 Between flanges : PN 10 - 16  
 Material :  
 • body and disc : stainless steel AISI 316  
 • gasket and O-Rings : FKM*

**Art.3443**

Valvola di ritegno a doppio battente

Double disc check valve

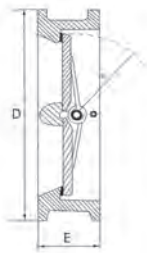

Misura	D	E	R	gr	
50	109	54	28,8	1500	1
65	129	54	36,1	2000	1
80	144	57	43,4	3000	1
100	164	64	52,8	4000	1
125	194	70	65,7	6000	1
150	220	76	78,6	9000	1
200	275	95	104	16000	1
250	330	108	127	25000	1
300	380	144	147	31000	1

Pressione di esercizio : PN 16

T. di utilizzo : -10°C + 150 °C

Inseribile tra flange : PN 10 -16

Materiale :

- corpo : Ghisa GG25 riv. epossidico
- guarnizione : FKM
- battenti : Acciaio Inox SS 316
- asse : Acciaio Inox
- molla : Acciaio Inox
- boccola : Teflon

Nominal pressure : PN 16

Working temperature : -10°C + 150°C

Between flanges : PN 10 - 16

Material :

- body : cast Iron epoxy coated
- gasket : FKM
- disc : **Stainless Steel 316**
- shaft : Stainless Steel
- spring : Stainless Steel
- washer : Teflon

**Art.3532**

Valvola di ritegno a disco

Wafer disc check valve

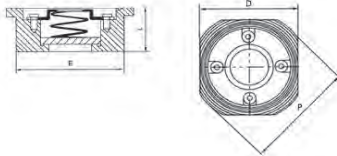

Misura	D	E	P	L	gr	
15	45	43	53	16	110	1
20	55	53	63	19	180	1
25	65	63	73	22	270	1
32	78	75	84	28	450	1
40	88	86	94	31,5	600	1
50	98	95	109	40	1000	1
65	118	115	129	46	1350	1
80	134	131	144	50	2000	1
100	154	151	164	60	3200	1

Pressione di esercizio: PN 40

T di utilizzo : 300°C

- corpo : CF8M
- disco : CF8M
- viti : Acciaio Inox SS 316
- tenuta molla : Acciaio Inox 316 SS
- molla : Acciaio Inox 316 SS

Nominal pressure : PN 40

Working T : 300°C

- body : CF8M
- disc : CF8M
- bolts : SS 316
- spring cover : 316 SS
- spring : 316 SS

**Art.3524**

Succheruola per Art.3531

Strainer for Art.3531

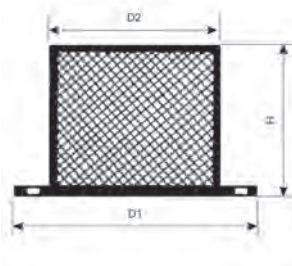
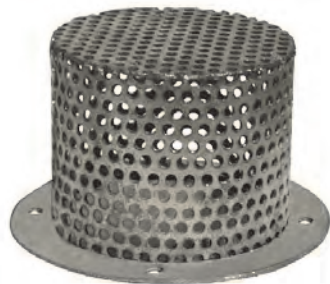

DN	D1	D2	H	gr	
50	156	111	80	550	1
65	176	131	100	700	1
80	192	148	120	750	1
100	212	168	150	1000	1
125	242	198	175	1650	1
150	276	222	200	2650	1
200	332	278	250	4050	1
250	385	329	300	5530	1

## SARACINESCHE E FILTRI FILTERS AND GATE VALVES

**Art.3447**

Saracinesca flangiata, CORPO PIATTO

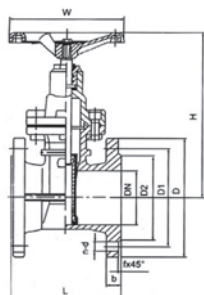
*Flanged gate valve, FLAT BODY*

 Cuneo gommato  
*Soft seated gate valve*

Misura	gr	
40	7700	1
50	9850	1
65	12200	1
80	14800	1
100	20480	1
125	28450	1
150	36300	1
200	60000	1
250	89300	1
300	124000	1

**Art.3448**

Saracinesca flangiata CORPO OVALE

*Flanged gate valve, OVAL BODY*

 Cuneo gommato  
*Soft seated gate valve*

Misura	gr	
40	8000	1
50	10800	1
65	13400	1
80	16400	1
100	22800	1
125	34000	1
150	43500	1
200	72500	1
250	113000	1

**Art.3445**

Valvola globo con soffiello

*Bellow globe valve*

Misura	DN	gr	
15	1/2"	3200	1
20	3/4"	3900	1
25	1"	4850	1
32	1.1/4"	6500	1
40	1.1/2"	9000	1
50	2"	11000	1
65	2.1/2"	15800	1
80	3"	24300	1
100	4"	35000	1
125	5"	49200	1
150	6"	76000	1
200	8"	130500	1

**Art.3520**

Filtro a Y flangiato

*Y strainer flanged*

DN	gr	
15	2300	1
20	3200	1
25	3900	1
32	5700	1
40	7000	1
50	11500	1
65	14500	1
80	18500	1
100	24000	1
125	38000	1
150	49000	1
200	94000	1
250	132000	1

## GIUNTI JOINTS

**Art.3810**

Giunto filettato PN 16, gomma EPDM

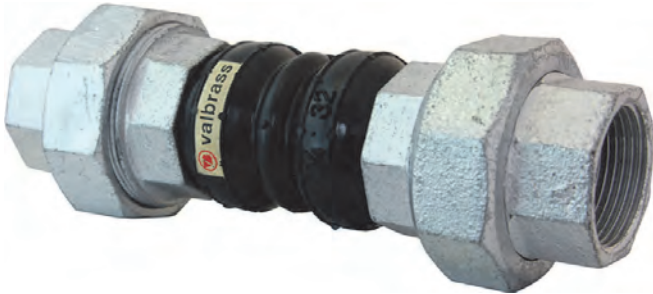
*Threaded joint PN 16, EPDM rubber*

Con gomma NBR su richiesta Art.3815  
With NBR rubber on request Art.3815

Misura	L	Ext.	Comp	Lat	Ang.	
1/2"	200	5-6	22	22	45°	10
3/4"	200	5-6	22	22	45°	10
1"	200	5-6	22	22	45°	10
1.1/4"	200	5-6	22	22	45°	10
1.1/2"	200	5-6	22	22	45°	10
2"	200	5-6	22	22	45°	5
2.1/2"	265	8-10	24	24	45°	5
3"	285	8-10	24	24	45°	5

Bocchettoni in ghisa

*Unions in malleable cast iron***Art.3810/I**

Giunto INOX filettato PN 16, EPDM

*Threaded SS 304 joint PN 16, EPDM rubber*

Misura	L	Ext.	Comp	Lat	Ang.	
1/2"	200	5-6	22	22	45°	10
3/4"	200	5-6	22	22	45°	10
1"	200	5-6	22	22	45°	10
1.1/4"	200	5-6	22	22	45°	5
1.1/2"	200	5-6	22	22	45°	5
2"	200	5-6	22	22	45°	5
2.1/2"	265	8-10	24	24	45°	1
3"	285	8-10	24	24	45°	1

Bocchettoni in AISI 304

*Unions in stainless steel AISI 304***Art.3810/O**

Giunto filettato PN 16, gomma NBR

*Threaded joint PN 16, NBR rubber*

Misura	L	Ext.	Comp	Lat	Ang.	
3/4"	203	6	22	22	32°	10
1"	203	6	22	22	25°	10
1.1/4"	203	6	22	22	25°	5
1.1/2"	203	6	22	22	20°	5
2"	203	6	22	22	15°	5

Bocchettoni in ottone

*Unions in brass*

**Art.3820** Giunto flangiato PN 16 AISI 316 ed EPDM *Flanged joint PN 16 AISI 316 and EPDM*

Misura	DN	L	FORI	L	Ang.	
1.1/4"	32	95	4	9	15°	5
1.1/2"	40	95	4	9	15°	5
2"	50	105	4	10	15°	5
2.1/2"	65	115	4	11	15°	1
3"	80	135	8	12	15°	1
4"	100	150	8	13	15°	1
5"	125	165	8	14	15°	1
6"	150	180	8	22	15°	1
8"	200	210	8	22	15°	1
10"	250	230	12	22	15°	1
12"	300	245	12	22	15°	1
14"	350	255	16	22	15°	1
16"	400	255	16	22	15°	1

Con gomma NBR su richiesta **Art.3825**

*With NBR rubber on request Art.3825*

Fino a DN150 (incluso) il PN10 equivale al PN16

*Till DN150 (included) PN10 is equal to PN16*

Art.3820/304 Giunto flangiato PN 16 con flangia in AISI 304 e gomma EPDM  
*Art.3820/304 Flanged Joint PN 16 in AISI 304 and EPDM rubber*

Art.3825/304 Giunto flangiato PN 16 con flangia in AISI 304 e gomma NBR  
*Art.3825/304 Flanged Joint PN 16 in AISI 304 and NBR rubber*

**Art.3845** Giunto in gomma EPDM, PN10 *Joint in EPDM, PN10*

Misura	DN	
1.1/4"	32	5
1.1/2"	40	5
2"	50	5
2.1/2"	65	1
3"	80	1
4"	100	1
5"	125	1
6"	150	1
8"	200	1

**Art.3850** Limitatori di corsa piani *Control rod set*

Misura	DN	LT	
1.1/4"	32	240	5
1.1/2"	40	240	5
2"	50	285	5
2.1/2"	65	285	1
3"	80	320	1
4"	100	320	1
5"	125	340	1
6"	150	370	1
8"	200	410	1
10"	250	480	1
12"	300	480	1
14"	350	500	1
16"	400	500	1
18"	450	500	1
20"	500	500	1
24"	600	500	1



## FLANGE

### FLANGES

**Art.32276** Flangia piana PN 6

*Plate flanges PN 6*

Flangia piana per saldatura a sovrapposizione  
PN 6 EN 1092-1 ( EX UNI 2276) DIN 2575

*Plate flanges*  
**PN 6**

DN	ø foro	ø ext	sp.	n°fori	inter.	Bulloni	
15	22	80	12	4	55	M10x40	10
20	27,5	90	14	4	65	M10x45	10
25	34	100	14	4	75	M10x45	10
32	43	120	16	4	90	M12x45	10
40	49	130	16	4	100	M12x45	10
50	61,5	140	16	4	110	M12x45	5
65	77	160	16	4	130	M12x45	5
80	90	190	18	4	150	M16x60	5
100	116	210	18	4	170	M16x60	1
125	141	240	20	8	200	M16x65	1
150	170	265	20	8	225	M16x65	1
200	221	320	20	8	280	M16x70	1
250	275	375	24	12	335	M16x70	1
300	326	440	24	12	395	M20x75	1
350	360	490	26	12	445	M20x80	1
400	411	540	28	16	495	M20x80	1
450	462	595	30	16	550	M20x80	1
500	513,5	645	30	20	600	M20x80	1

**Art.32277** Flangia piana PN 10

*Plate flanges PN 10*

Flangia piana per saldatura a sovrapposizione  
PN 10 EN 1092-1 ( EX UNI 2277) DIN 2576

*Plate flanges*  
**PN 10**

DN	ø foro	ø ext	sp.	n°fori	inter	Bulloni	
80	90	200	22	4	160	M16x65	1
200	221	340	26	8	295	M20x80	1
250	275	395	28	12	350	M20x85	1
300	325	445	28	12	400	M20x85	1
350	358	505	30	16	460	M20x85	1
400	409	565	32	16	515	M22x85	1
450	462	615	34	20	565	M22x85	1
500	510	670	34	20	620	M22x90	1
600	617	780	42	20	725	M27X95	1
700	714	895	38	24	840	M27X100	1
800	816	1015	40	24	950	M30X105	1
900	917	1050	42	28	1050	M30X110	1
1000	1019	1160	44	28	1160	M33X115	1

**Art.32278** Flangia piana PN 16

*Plate flanges PN 16*

Flangia piana per saldatura a sovrapposizione  
PN 16 EN 1092-1 ( EX UNI 2278) DIN 2576

*Plate flanges*  
**PN 16**

DN	ø foro	ø ext.	sp.	n°fori	inter	Bulloni	
15	22	95	14	4	65	M12x50	10
20	27,5	105	16	4	75	M12x50	10
25	34	115	16	4	85	M12x50	10
32	43	140	18	4	100	M16x60	10
40	49	150	18	4	110	M16x60	10
50	61,5	165	20	4	125	M16x60	5
65	77	185	20	4	145	M16x60	5
80	90	200	22	8	160	M16x65	5
100	116	220	22	8	180	M16x65	1
125	141	250	24	8	210	M16x70	1
150	170	285	24	8	240	M20x75	1
200	221	340	26	12	295	M20x80	1
250	275	405	29	12	355	M24x90	1
300	326	460	32	12	410	M24x90	1
350	360	520	36	16	470	M24x95	1
400	411	580	38	16	525	M27x105	1
450	462	640	42	20	585	M27x105	1
500	513,5	715	44	20	650	M30x110	1
600	616	840	52	20	770	M33x115	1
700	714	910	46	24	840	M33x115	1
800	816	1025	46	24	950	M36x135	1
900	917	1125	50	28	1050	M36x135	1
1000	1019	1255	50	28	1170	M39x140	1

**Art.32253** Flangia filettata PN 6

*Threaded flange PN 6*

Flangia filettata a collare con rigatura  
PN 6 EN 1092-1 ( EX UNI 2253) DIN 2565

*Threaded flanges*  
**PN 6**

DN	ø foro	ø ext.	sp.	n°fori	inter	Bulloni	
15	1/2"	80	12	4	55	M10X40	10
20	3/4"	90	14	4	65	M10X45	10
25	1"	100	14	4	75	M10X45	10
32	1.1/4"	120	14	4	90	M12X45	10
40	1.1/2"	130	14	4	100	M12X45	10
50	2"	140	14	4	110	M12X45	5
65	2.1/2"	160	14	4	130	M12X45	5
80	3"	190	16	4	150	M16X60	5
100	4"	210	16	4	170	M16 X60	1

**Art.32254** Flangia filettata PN 16

*Threaded flange PN 16*

Flangia filettata a collare con rigatura  
PN 16 EN 1092-1 ( EX UNI 2254) DIN 2566

*Threaded flanges*  
**PN 16**

DN	ø foro	ø ext.	sp.	n°fori	inter	Bulloni	
15	1/2"	95	14	4	65	M12X50	10
20	3/4"	105	16	4	75	M12X50	10
25	1"	115	16	4	85	M12X50	10
32	1.1/4"	140	16	4	100	M16X60	4
40	1.1/2"	150	16	4	110	M16X60	4
50	2"	165	18	4	125	M16X60	4
65	2.1/2"	185	18	4	145	M16X60	4
80	3"	200	20	8	160	M16X65	8
100	4"	220	20	8	180	M16X65	8
125	5"	250	22	8	210	M16X70	8
150	6"	285	22	8	240	M20X75	8

**Art.32280** Flangia a collare PN 6

*Welding neck flange PN 6*

Flangia a collare per saldatura di testa  
PN 6 EN 1092-1 ( EX UNI 2280) DIN 2631

*Welding neck flanges*  
*PN 6*

**Art.32281** Flangia a collare PN 10

*Welding neck flange PN 10*

Flangia a collare per saldatura di testa  
PN 10 EN 1092-1 ( EX UNI 2281) DIN 2632

*Welding neck flanges*  
*PN 10*

**Art.32282** Flangia a collare PN 16

*Welding neck flange PN 16*

Flangia a collare per saldatura di testa  
PN 16 EN 1092-1 ( EX UNI 2282) DIN 2633

*Welding neck flanges*  
*PN 16*

DN	ø foro	ø est.	sp.	n°fori	inter	Bulloni	
25	34,5	100	14	4	75	M10X45	1
32	43,5	120	14	4	90	M12X45	1
40	49,5	130	14	4	100	M12X45	1
50	61,5	140	14	4	110	M12X45	1
65	77	160	14	4	130	M12X45	1
80	90	190	16	4	150	M16X60	1
100	116	210	16	4	170	M16X60	1
125	141	240	18	8	200	M16X65	1
150	171	265	18	8	225	M16X65	1
200	221	320	20	8	280	M16X70	1
250	275	375	24	12	335	M16x70	1
300	326	440	24	12	395	M20x75	1

DN	ø foro	ø est.	sp.	n°fori	inter	Bulloni	
80	80	200	20	4	160	M16X65	1
200	221	340	24	8	295	M20X80	1
250	275	395	26	12	350	M20X85	1
300	326	445	26	12	400	M20X85	1
350	358	505	26	16	460	M20X85	1
400	409	565	26	16	515	M22X85	1
450	459	615	26	20	565	M22X85	1
500	510	620	28	20	620	M22X90	1
600	617	780	42	20	725	M27X95	1

DN	ø foro	ø ext	sp.	n°fori	inter	Bulloni	
15	22,5	95	14	4	65	M12x50	10
20	28	105	16	4	75	M12X50	10
25	34,5	115	16	4	85	M12X50	10
32	43,5	140	16	4	100	M16X60	10
40	49,5	150	16	4	110	M16X60	10
50	61,5	165	18	4	125	M16X60	5
65	77	185	18	4	145	M16X60	5
80	90	200	20	8	160	M16X65	5
100	116	220	20	8	180	M16X65	1
125	141	250	22	8	210	M16X70	1
150	171	285	22	8	240	M20X75	1
200	221	340	24	12	295	M24X90	1
250	275	405	26	12	355	M24X90	1
300	326	460	28	12	410	M24X95	1
350	358	520	30	16	470	M27X105	1
400	409	580	32	16	525	M27X105	1
450	459	640	40	20	585	M30X110	1
500	510	715	44	20	650	M33X115	1
600	612	840	54	20	770	M33X115	1

**Art.36092** Flangia cieca PN 10

*Blank flanges PN 10*

DN	ø foro	ø est.	sp.	n°fori	inter	Bulloni	
80		200	22	4	160	M16x65	1
200		340	26	8	295	M20X80	1
250		395	28	12	350	M20X85	1
300		445	28	12	400	M20X85	1
350		505	26	16	460	M20X85	1
400		565	26	16	515	M22X85	1
450		615	28	20	565	M22X85	1
500		620	28	20	620	M22X90	1

Flangia cieca  
PN 10 EN 1092-1 ( EX UNI 6092) DIN 2527

*Blank flanges  
PN 10*

**Art.36093** Flangia cieca PN 16

*Blank flange PN 16*

DN	ø foro	ø est.	sp.	n°fori	inter	Bulloni	
15		95	14	4	65	M12x50	10
20		105	16	4	75	M12X50	10
25		115	16	4	85	M12X50	10
32		140	18	4	100	M16X60	10
40		150	18	4	110	M16X60	10
50		165	20	4	125	M16X60	5
65		185	20	4	145	M16X60	5
80		200	22	8	160	M16X65	5
100		220	22	8	180	M16X65	1
125		250	24	8	210	M16X70	1
150		285	24	8	240	M20X75	1
200		340	26	12	295	M20X80	1
250		405	32	12	355	M24X90	1
300		460	32	12	410	M24X90	1
350		520	36	16	470	M24X95	1
400		580	38	16	525	M27X105	1
450		640	40	20	585	M27X105	1
500		715	44	20	650	M30X110	1
600		840	54	20	770	M33X115	1

Flangia cieca  
PN 16 EN 1092-1 ( EX UNI 6092) DIN 2527

*Blank flanges  
PN 16*

**Art.3000** Collari

Clamp



Misura	Vite	
3/8"	M8	2
1/2"	M8	2
3/4"	M8	2
1"	M8	2
1.1/4"	M8	2
1.1/2"	M8	2
2"	M8	2
2.1/2"	M10	2
3"	M10	2
4"	M10	2

**Art.3750** Mastice in pasta Professionale

Sealant (certified for gas use)



Misura	
1 460 gr	1

Per le tenute di gas, metano, vapore, acqua calda/fredda, liquidi alimentari, ecc.  
Da impiegare con canapa - prodotto certificato

**Art.3760** Mastice in pasta Standard

Sealant (standard use)



Misura	
1 400 gr	1

Per le tenute di acqua calda/fredda, aria compressa, ecc.  
Da impiegare con canapa

**Art.GL** Colla SIGILLANTE

SEALANT glue



Misura	
GL 628 PTFE SIGILLANTE A MEDIA RESISTENZA	100 ml 1
GL 335 TO SIGILLANTE AD ALTA RESISTENZA	250 ml 1

**Art.3770** Canapa extra fine

Hempextra fine



Articolo	
3770/06	25 kg 1 balle da 25 kg
3770/01	50 kg 2 balle da 25 kg
3770/02	1 kg buste
3770/03	250 g buste da appendere
3770/04	150 g rocchetti da appendere
3770/05	80 g rocchetti da appendere

**Art.669/G** Rotolo di Teflon

*Teflon roll*

Misura	
12mmx12Mx0,075mm	250
12mmx12Mx0,1mm	250
19mmx15Mx0,2mm	200
25mmx15Mx0,2mm	200

**Art.3700** Silicon tape

*Silicon tape*

Misura	Dimensioni	
14	14mmx5m	1
14	14mmx15m	1
19	19mmx15m	1

Nastro sigillante per raccordi idraulici  
Riposizionabile , compatibile con tutti i metalli  
e materiali plastici.  
Conforme normative gas e acqua  
Sostituisce pasta canapa nastri in P.T.F.E.

Sealant tape for hydraulik use  
For all metal and plastic surfaces  
You can adjust the position after assembled without any leakage  
Certified for water and gas  
It substitutes hemp and PTFE

**Art.9000** Guarnizione in fibra verde Fasit

*Fiber flat gasket, green*

Misura	dimensioni	
1/8"	8x4x1,8	100
1/4"	11x6x1,8	100
3/8"	14,5x8x1,8	100
1/2"	18,5x11x1,8	100
3/4"	24x16x1,8	100
1"	30x22x1,8	100
1.1/4"	39x30x1,8	100
1.1/2"	44x33x1,8	100
2"	56x43x1,8	100
2.1/2"	72x54x1,8	100

**Art.9020** Guarnizioni in Fibra per bocchettoni in ghisa

*Fiber flat gasket for malleable iron union fittings*

Misura	dimensioni	
3/8"	28x19x1,8	100
1/2"	33x24,5x1,8	100
3/4"	37x27x1,8	100
1"	44x33x1,8	100
1.1/4"	56x43x1,8	100
1.1/2"	62x46,5x1,8	100
2"	79x60,5x1,8	100
2.1/2"	95x75x1,8	100
3"	110x89x1,8	100
4"	136x114x1,8	100

**Art.9040**

Guarnizioni in Fibra per flange PN 10/16

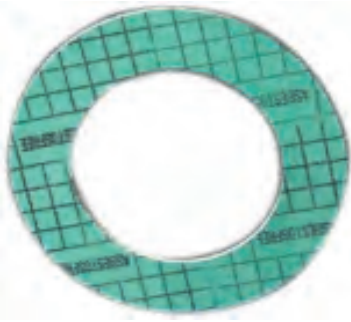
*Fiber flat gasket for flanges PN 10/16*

DN	dimensioni	
15	28x19	10
20	33x24,5	10
25	37x27	10
32	44x33	10
40	56x43	10
50	62x46,5	10
65	79x60,5	10
80	95x75	10
100	110x89	10
125	136x114	10
150		10

**Art.9040/G**

Guarniz. Gomma telata per flange PN 10/16

*Rubber gaskets for flanges PN 10/16*

DN	dimensioni	
15	28x19	10
20	33x24,5	10
25	37x27	10
32	44x33	10
40	56x43	10
50	62x46,5	10
65	79x60,5	10
80	95x75	10
100	110x89	10
125	136x114	10
150		10

**Art.9045**

Guarnizioni in Fibra per flange PN 6

*Fiber flat gasket for flanges PN 6*

DN	dimensioni	
15	28x19	10
20	33x24,5	10
25	37x27	10
32	44x33	10
40	56x43	10
50	62x46,5	10
65	79x60,5	10
80	95x75	10
100	110x89	10
125	136x114	10

**Art.9050**

Guarnizione in Fibra morbida

*Fiber flat gasket, soft type*

Misura	dimensioni	
3/4"		100
1"		100

**Art.9100**

Guarnizione in Fibra rossa

*Fiber flat gasket, red*

Misura	Dimensioni	
3/4"	14,5x24,5x1,5	100
1"	24x30,5x1,5	100

**Art.9200**

Guarnizione NBR

*NBR flat gasket*

Misura	dimensioni	
1/2"	18,5x11x2	100
3/4"	24x16x2	100
1"	30x22x2	100
1.1/4"	39x30x2	100
1.1/2"	44x33x2	100
2"	56x43x2	100

**Art.9200/T**

Guarnizione in Teflon x filetto maschio

*Teflon flat gasket for male thread*

Misura	dimensioni	
3/8"	25x17x2	100
1/2"	25x21x2	100
3/4"	35x26,5x2	100
1"	42x33,5x2,5	100

\* Prezzi su richiesta / Prices on request

**Art.9230**

Guarnizione in Poliuretano

*Polyurethane flat gasket*

Misura	dimensioni	
1"	30x24x2	100

**Art.9250**

Guarnizione NBR lobate

*Four-points flat NBR gaskets*

Misura	dimensioni	
1/2"	18,5x11x2	100
3/4"	24x16x2	100
1"	30x22x2	100



**Art.300/H** Maniglia per Art.300 e Art.305

*Handle for Art.300 and Art.305*



Maniglia in acciaio cromato con guaina rossa  
*Handle in Chromium Plated Steel with red rubber covered*

Misura	
1/4" - 3/8"	1
1/2" - 3/4"	1
1"	1
1.1/4"	1
1.1/2"	1
2"	1
2.1/2"	1
3"	1
4"	1

**Art.310/H** Farfalla rossa per Art.310 e Art.315

*"T" handle for Art.310 and Art.315*



Farfalla in Alluminio rossa  
*Red wing handle in Aluminium*

Misura	
1/2"	1
3/4"	1
1"	1

**Art.415/H** Maniglia per Art.415-421-414-428

*Handle for Art.415-421-414-428*



Maniglia in acciaio cromato con guaina rossa

*Handle in Chromium Plated Steel with red rubber covered*

Misura	
1/4" - 3/8"	1
1/2" - 3/4"	1
1"	1
1.1/4"	1
1.1/2"	1
2"	1
2.1/2"	1
3"	1
4"	1

**Art.416/H**

Art.416/H Maniglia in Alluminio nera  
*Art.416/H Black handle in Aluminium*



**Art.451/H**

Art.451/H Maniglia in acciaio cromato con guaina gialla  
*Art.451/H Handle in Chromium Plated Steel with yellow rubber covered*



**Art.420/H** Farfalla rossa per Art.420-422-427-429

"T" handle for Art.420-422-427-429

 Farfalla rossa in Alluminio  
*Red wing handle in Aluminium*

Misura	
1/4" - 3/8"	1
1/2" - 3/4"	1
1"	1
1.1/4"	1
1.1/2"	1

**Art.453/H**

 Art.453/H Farfalla gialla in Alluminio  
*Art.453/H Yellow wing handle in Aluminium*
**Art.450/H** Maniglia per Art.445-447-450

Handwheel for Art.445-447-450



Misura	
1/4" - 3/8" - 1/2" - 3/4"	1
1"	1
1.1/4" - 1.1/2"	1
2"	1
2.1/2" - 3"	1
4"	1
5" - 6"	1

 Volantino in alluminio verniciato rosso  
*Aluminium handwheel red painted*
**Art.460/H** Maniglia per Mini valvole

Handle for Art.460 and Art.465

 Maniglia rossa in Alluminio  
*Red handle in Aluminium*

	1
--	---

**Art.461/H**

 461/H Maniglia nera in Alluminio  
*461/H Black handle in Aluminium*

	1
--	---

**Art.465/SH**

 Art.465/SH Maniglia nera in Zama cromata  
*Art.465/SH Chrome plated zinc alloy handle*

	1
--	---

**INDICE ANALITICO / INDEX**

Articolo	pagina	Articolo	pagina	Articolo	pagina	Articolo	pagina
1	49	132/L/G	33	1903	99	2421	167
1000	101	133	31	1904	99	2421/S	169
1005	101	134	32	1905	99	2422	167
1010	101	134/V	32	1906	99	243	138
1015	101	135/L	36	1907	99	2447	169
1020	102	135	37	191	112	245	110
1025	102	1400	136	195	112	245/S	110
1030	102	1405	136	197	112	246	17
1035	102	1410	136	200	111	2460	168
1040	102	1415	136	2000	168	2460/NPT	172
1050	103	1420	136	2000/AD	173	2465	169
1055	103	1425	137	2000/AS	173	2465/NPT	172
1060	103	1430	137	2000/E	173	248	79
1060/P	103	1435	137	205	110	249/B	70
1065	103	144/AI	107	210	137	250	70
1070	103	145	109	21250	170	2500	169
110	31	146	107	21251	170	2501	169
1100	151	1460	144	21252	171	250/B	70
1105	152	1461	144	213	138	251	71
1106	152	1462	144	2132	157	251/B	70
1110	152	1463	144	2134	157	252	75
1115	152	1464	144	2145	158	252/E	75
1120	153	147	107	2150	157	252/T	75
1130	153	148	110	2152	157	2520	165
1135	153	1480	137	2170	165	254/S, 254/S/PG	73
1136	153	149	107	220	41	255/P	73
1140	153	1490	137	220/N	41	255	74
1145	154	150	32	221	42	255/G	74
1145/B	154	151	33	221/N	42	256	28
1146	154	152	34	2235	158	257	28
1148	154	152/L	34	2245	159	258	28
1149	154	152/L/NPT	34	2260	164	2587	60
115	37	152/U	35	2260/F	164	2588	60
1150	155	153	35	2263	164	259	16
1155	155	153/L	34	2265	164	2590	159
1160	155	155	38	2266	165	2592	159
1165	155	160	39	2280	135	2593	160
1170	155	166	108	2293	159	2595	160
1200/N	141	168	108	2300	170	260	114
1203	141	170	108	2330	166	260/N	114
1204	141	1700	14	2331	166	2600	160
1205	141	1705	14	2331/D	166	2604	160
1206	141	171	108	235	39	2605	161
1210	142	1710	14	235/A	39	261	113
1211	142	1715	14	240	113	2610	161
1250	142	174	108	2407	168	2615	162
1255	142	180	111	2407/AD	173	262	113
1260	142	1800	96	2407/AS	173	262/N	113
1261	142	1801	96	2407/E	173	2620	162
1265	143	1802	96	2408	168	2621	162
1270	143	1805	96	2408/AD	173	2625	163
1275	143	1806	96	2408/AS	173	263	114
1280	143	1826	98	2408/E	173	2635	163
1285	143	1827	98	2410	166	2636	163
130	31	185	111	2415	167	2637	163
130/L	31	1855	98	2415/NPT	172	264	115
130/NY	158	190	112	2415/S	169	265	115
131	31	1901	99	242	138	2658	163
132	33	1902	99	2420	167	2658/A	164

266-----	114	320/B/R-----	92	3595/D (FIG.132)---	182	3810-----	210
2660-----	161	320/B/R/A-----	92	3595/S (FIG.471)---	191	3810/I-----	210
267-----	115	320/B/V-----	92	3595/N-----	192	3810/O-----	210
269-----	115	320/B/V/A-----	92	3596 (FIG.85)-----	177	3820-----	211
270-----	116	320/N-----	92	3596/U (FIG.85)-----	177	3845-----	211
271-----	117	320/N/A-----	92	3597 (FIG.131)-----	182	3850-----	211
2710-----	56	321-----	93	3598 (FIG.1221)-----	184	3960 (FIG.2220)---	184
2715-----	56	321/A-----	93	3599 (FIG.1223)-----	184	400-----	23
272-----	117	321/B-----	93	3600 (FIG.92)-----	178	403-----	23
275-----	116	321/B/A-----	93	36092-----	215	405-----	23
276-----	117	321/C-----	93	36093-----	215	406-----	23
277-----	116	321/C/A-----	93	3600/M (FIG.94)---	179	407-----	22
277/F-----	116	321/N-----	93	3600/R (FIG.92R)---	179	407/AS-----	173
278-----	116	321/N/A-----	93	3602 (FIG.1)-----	176	407/AD-----	173
278/F-----	116	32276-----	212	3603 (FIG.2)-----	176	407/E-----	173
280-----	135	32277-----	212	3604 (FIG.3)-----	176	408-----	22
2800-----	105	32278-----	213	3605 (FIG.280)-----	188	408/AS-----	173
285-----	37	32253-----	213	3606 (FIG.281)-----	189	408/AD-----	173
286-----	41	32254-----	213	3610 (FIG.245)-----	187	408/E-----	173
286/N-----	41	32280-----	214	3615 (FIG.241)-----	186	410-----	91
286/S-----	41	32281-----	214	3620 (FIG.270)-----	188	410/A-----	91
286/SN-----	41	32282-----	214	3620/N-----	192	410/B-----	91
293-----	135	3260 (FIG.341)-----	191	3621 (FIG.529)-----	188	410/BA-----	91
293/R-----	135	3260/F (FIG.331D)-	190	3621/N-----	192	410/F-----	91
295-----	38	3263 (FIG.340)-----	190	3622 (FIG.271)-----	188	410/N-----	91
296-----	38	3263/F (FIG.330D)-	190	3625 (FIG.240)-----	185	410/NA-----	91
297-----	41	3265 (FIG.98)-----	180	3625/N-----	193	410/R-----	91
298-----	40	3265/F (FIG.97D)---	179	3626 (FIG.246)-----	187	410/RA-----	91
298/N-----	40	3266 (FIG.96)-----	179	363/R/AS-----	16	411-----	22
299-----	41	3266/F (FIG.95D)---	179	3635 (FIG.290)-----	189	412-----	94
299/N-----	41	3293 (FIG.310)-----	190	3637 (FIG.300)-----	189	413-----	22
300-----	25	330-----	93	3637/N-----	193	414-----	8
300/N-----	25	3371 (FIG.371)-----	191	3638 (FIG.301)-----	189	414/B-----	8
300/H-----	220	3372 (FIG.372)-----	191	364/G-----	16	414/L-----	6
3000-----	216	3374 (FIG.374)-----	191	365-----	18	414/N-----	8
305-----	25	3440-----	207	3658/N-----	194	414/SC-----	19
3007-----	140	3441-----	207	3659-----	194	414/Y-----	8
305/N-----	25	3442-----	207	3659/N-----	195	415-----	11
310-----	25	3443-----	208	366-----	17	415/AS-----	173
310/H-----	220	3447-----	209	3660 (FIG.531)-----	186	415/AD-----	173
3100-----	171	3445-----	209	367-----	17	415/B-----	11
3105-----	171	3448-----	209	367/B-----	17	415/E-----	173
3110-----	171	350-----	138	368-----	17	415/F-----	16
3120-----	202	351-----	138	368/B-----	17	415/H-----	220
3120/AD-----	204	3520-----	209	370-----	18	415/LO-----	11
3120/AS-----	204	3524-----	208	3700-----	217	416-----	11
3120/E-----	204	3530-----	206	370/N-----	18	416/E-----	12
3120/G-----	202	3530/F-----	206	3702 (FIG.41)-----	177	416/PE-----	13
3121-----	202	3531-----	206	3703 (FIG.40)-----	177	416/H-----	220
3122-----	203	3532-----	208	3704 (FIG.121)-----	180	417-----	13
3130-----	203	3590 (FIG.130)-----	180	3705 (FIG.120)-----	180	418-----	11
3130/AD-----	205	3590/A (FIG.165)---	183	371-----	15	419-----	13
3130/AS-----	205	3590/M (FIG.135)---	183	371/F-----	15	420-----	12
3130/E-----	205	3590/N (FIG.135)---	193	371/F/N-----	15	420/H-----	220
3131-----	203	3591 (FIG.130R)---	181	372-----	18	420/N-----	12
3140-----	202	3592 (FIG.180)-----	183	372/N-----	18	421-----	11
315-----	25	3592/R (FIG.180R)-	184	3750-----	216	421/B-----	11
320-----	92	3593 (FIG.133)-----	183	3760-----	216	421/LO-----	12
320/A-----	92	3593/L (FIG.134)---	183	3770-----	216	422-----	12
320/B-----	92	3594 (FIG.90R)-----	178	380-----	21	422/N-----	12
320/B/A-----	92	3595 (FIG.90)-----	178	381-----	21	425-----	15

426-----	15	475-----	48	589/B-----	59	640/T-----	42
426/N-----	15	475/N-----	48	590-----	118	642-----	43
427-----	9	475/T-----	48	590/M-----	118	643-----	43
427/L-----	6	476-----	48	590/R-----	117	645-----	42
427/N-----	9	478-----	94	591-----	118	645/S-----	42
428-----	8	480-----	28	592-----	118	649-----	128
428/B-----	8	485-----	28	593-----	120	649/G-----	128
428/L-----	6	495-----	29	594-----	119	650-----	129
428/N-----	8	499-----	19	595-----	119	6500-----	81
429-----	9	500-----	29	596-----	119	6505-----	81
429/L-----	6	5000-----	145	597-----	119	651-----	130
4293-----	199	5100-----	145	600-----	120	6510-----	81
429/N-----	9	5150-----	145	600/R-----	121	6520-----	82
435-----	49	5200-----	145	6000-----	86	6525-----	82
440-----	49	5210-----	145	6005-----	87	6530-----	83
441-----	45	505-----	29	601-----	120	6535-----	83
445-----	44	510-----	29	6010-----	87	6550-----	84
446-----	43	515-----	29	602-----	120	6555-----	84
447-----	44	519-----	35	603-----	121	657-----	132
447/S-----	44	520-----	39	604-----	121	6570-----	85
448-----	43	520/M-----	40	605-----	121	6571-----	85
448/S-----	43	521-----	40	605/S-----	121	6575-----	85
449-----	45	522-----	39	606-----	122	6576-----	85
450-----	44	524-----	40	607-----	122	658-----	113
450/H-----	221	525-----	40	608-----	122	659-----	131
451-----	27	530-----	139	609-----	123	6590-----	140
451/H-----	220	535-----	139	609/D-----	123	660-----	128
452-----	27	540-----	139	610-----	123	661-----	128
453-----	27	545-----	139	6100-----	88	661/N-----	128
453/H-----	221	545/S-----	139	6105-----	89	663-----	73
454-----	27	550-----	139	611-----	123	666-----	72
460-----	20	560-----	140	6110-----	89	669/G-----	217
4605-----	198	560/C-----	140	6115-----	90	671-----	71
460/H-----	221	562-----	140	612-----	124	672-----	72
461-----	20	563-----	140	6130-----	90	673-----	72
4610-----	197	567-----	95	6135-----	90	680-----	133
4615-----	196	567/C-----	95	615-----	124	680/D-----	134
461/F-----	20	567/S-----	95	616-----	124	681-----	133
461/H-----	221	568-----	97	617-----	74	681/D-----	134
4625-----	196	569/G-----	97	617/S-----	75	682-----	133
4630-----	197	569/B-----	97	618-----	75	682/D-----	134
4635-----	198	569/BC-----	97	618/S-----	74	683-----	133
4636-----	198	570-----	95	619/S-----	74	683/D-----	134
4637-----	198	570/K-----	95	620-----	125	684-----	129
464-----	45	572-----	97	620/N-----	125	685-----	129
465-----	20	573-----	98	621-----	125	686-----	130
465/SH-----	221	575-----	71	624-----	75	687-----	130
4650-----	199	576/R-----	71	623-----	128	700-----	53
4656-----	199	578-----	79	625-----	125	7000-----	76
465/S-----	20	579-----	79	630-----	125	7000/T-----	76
465/T-----	19	580-----	79	631-----	126	7001-----	76
466-----	20	584-----	60	632-----	122	7001/T-----	76
4660-----	197	585-----	58	635-----	126	7005-----	76
466/F-----	20	585/B-----	58	635/OR-----	126	7006-----	76
466/FA-----	21	586-----	58	635/T-----	126	7006/T-----	76
466/FA/B-----	21	587-----	59	636-----	127	7010-----	76
467-----	46	587/F-----	59	637-----	127	7015-----	76
468-----	46	587/FG-----	59	637/S-----	145	7020-----	77
469-----	45	587/R-----	60	638-----	127	7021-----	77
470-----	4	588-----	58	639-----	127	7022-----	77
471-----	4	589-----	58	640-----	42	7025-----	77

7030-----	78	845-----	63	930/L-----	148
7035-----	78	845/A-----	63	935-----	148
7040-----	78	845/AS-----	63	935/L-----	148
7045-----	78	845/PM-----	66	940-----	149
705-----	53	846-----	65	940/L-----	149
706-----	51	847-----	64	945-----	149
710-----	54	847/PM-----	66	950-----	149
715-----	54	848-----	62	955-----	149
715/F-----	54	850-----	62	960-----	150
716-----	55	850/A-----	62	965-----	150
720-----	56	850/AS-----	62	970-----	150
721-----	51	851-----	64	975-----	150
722-----	51	855-----	65	980-----	151
725-----	50	856-----	65	985-----	151
726-----	51	857/PM-----	66	990-----	151
730-----	50	860-----	64	GL-----	216
735-----	50	861-----	64		
740-----	50	865-----	64		
745-----	50	866-----	68		
746-----	55	867-----	68		
747-----	55	868-----	68		
748-----	55	869-----	68		
749-----	52	870-----	69		
750-----	61	871-----	69		
755-----	61	872-----	69		
760-----	61	875-----	68		
765-----	61	876-----	69		
772-----	52	889-----	67		
775-----	94	890-----	66		
776-----	94	891-----	66		
780-----	52	895-----	67		
781-----	52	895/P-----	68		
790-----	52	896-----	66		
799-----	19	897-----	67		
800-----	105	900-----	147		
801-----	105	900/L-----	147		
802-----	106	9000-----	217		
803-----	106	9020-----	217		
810-----	106	9040-----	218		
811-----	106	9040/G-----	218		
820-----	46	9045-----	218		
820/S-----	46	9050-----	218		
825-----	47	905-----	147		
830-----	47	905/L-----	147		
830/T-----	47	910-----	147		
835-----	47	910/L-----	147		
836-----	62	9100-----	218		
836/B-----	62	915-----	147		
836/R-----	63	915/L-----	147		
836/R/O-----	63	920-----	148		
837-----	62	9200-----	219		
838-----	62	9200/T-----	219		
839-----	62	920/L-----	148		
840-----	63	9230-----	219		
840/A-----	63	925-----	148		
841-----	64	9250-----	219		
842-----	63	925/L-----	148		
844-----	65	930-----	148		

## **CONDIZIONI GENERALI DI VENDITA**

### **FATTURAZIONE**

Per emissione Ri.Ba. si richiede un minimo di 500 € di imponibile, al di sotto il pagamento è con bonifico anticipato.

Per imponibile inferiore a 300 € verranno applicate spese amministrative pari a 15 €.

Eventuali eccezioni devono essere preventivamente concordate tra le parti.

### **TRASPORTO**

Sempre in Porto Assegnato salvo accordi preventivi tra le parti.

In alternativa spedizione a mezzo ns. corriere convenzionato con addebito in fattura del trasporto.

Nord : 3 % con addebito minimo di 20 € + IVA

Centro e Sud : 4 % con addebito minimo di 25 € + IVA

Isole : 5 % con addebito minimo di 30 € + IVA

E' disponibile su richiesta anche un servizio di trasporto Urgente e Prioritario con una maggiorazione del 40 % sulle tariffe sopra citate.

Il Contrassegno è possibile applicando una maggiorazione del 4 % con un addebito minimo di 15 €.

I Trasportatori applicano delle maggiorazioni sulle tariffe per consegne in aree disagiate, quindi, in caso la sede di ricezione merci del cliente risultasse in una di quelle zone, la VALBRASS comunicherà una diversa tariffa da addebitare in fattura, così come per l'eventuale richiesta di Sponda Idraulica.

### **CONSEGNE**

I tempi di consegna sono puramente indicativi. Eventuali ritardi non autorizzano a richieste danni o ad annullamento ordini. La merce viaggia a rischio e pericolo del Committente e, anche se venduta franco destinatario, ci riteniamo sollevati da ogni responsabilità per eventuali ammanchi o avarie che debbono essere fatte valere nei confronti del trasportatore.

Il cliente è tenuto a verificare l'integrità dell'imballo; invitiamo ad accettare la merce solo con diritto di Riserva se l'imballo non risultasse in perfette condizioni.

Con richiesta di preavviso da parte del vettore il giorno prima della consegna verranno addebitati 3 €.

Eventuali giacenze presso il deposito del vettore e le conseguenti riconsegne verranno addebitate al costo previa giusta causa.

Eventuale materiale a Saldo verrà inviato in un successivo ordine solo se preventivamente concordato

Non sarà effettuata spedizione se i pagamenti precedenti non dovessero risultare regolarizzati.

### **SPESE**

Vengono addebitate le spese di emissione Ri.Ba. pari a 3 € cada una salvo differenti accordi preventivi.

Verranno aumentati i prezzi di un 10 % in caso non si rispettassero almeno le confezioni minime standard.

E' consigliato l'utilizzo del portale [www.valbrass.com](http://www.valbrass.com) per l'emissione degli ordini.

Utilizzare il Nome Utente e la Password forniti dall'azienda per poter accedere all'area riservata; in caso non si fosse in possesso di tali dati, richiederli alla direzione della VALBRASS.

Imballaggio già incluso nel prezzo.

### **ORDINI**

Tutti gli ordini si intendono assunti a titolo di prenotazione e non impegnano la nostra società alla consegna, anche parziale, di quanto ordinato e sulla data d'evasione degli stessi.

L'ordine confermato non è annullabile salvo particolari accordi tra le parti.

### **QUANTITA'**

Le quantità indicate nell'ordine verranno modificate in base alle nostre confezioni standard salvo accordi presi in precedenza e confermati di volta in volta. Le quantità delle confezioni presenti a catalogo sono da considerarsi puramente indicative e possono subire variazioni a nostra discrezione senza nessun avviso

## **PAGAMENTO**

Emissioni Ri.Ba. a 30 o 60 gg. fine mese. Altre condizioni particolari dovranno essere preventivamente discusse ed autorizzate dalla VALBRASS S.r.l..

In caso di insoluto, o comunque di mancato pagamento rispetto al termine pattuito, si fa riferimento alla normativa di cui alla legge n° 192/2012 che prevede l'automatica maturazione di interessi moratori, senza alcuna ulteriore esigenza di notifica, nella misura dell'8 % in più rispetto al tasso fissato dalla BCE oltre all'applicazione di un rimborso fisso nella misura di 40 €.

Non sono ammesse detrazioni per abbuoni, arrotondamenti, ecc. che non siano concordati in precedenza. Il ritardato pagamento anche di una rata o l'inesatto o incompleto pagamento del prezzo comporta l'automatica messa in mora dell'acquirente che dovrà corrispondere alla VALBRASS S.r.l. gli interessi commerciali.

Gli ordini di clienti con problemi di insolvenza saranno accettati solo previo pagamento anticipato.

La VALBRASS S.r.l. si riserva il diritto di scelta. Il rilascio di effetti cambiari o altri titoli è fatto ed accettato "salvo buon fine" e non pregiudica le clausole di cui sopra.

Verranno posticipate rispettivamente al 05/09 e al 10/01 solamente le Ri.Ba. con scadenza fine Agosto e fine Dicembre; tutte le altre scadenze si intendono sempre a Fine Mese.

Ogni cliente Nuovo per VALBRASS verrà fornito solo previo Pagamento Anticipato per almeno il primo ordine. Successivamente verrà assegnato un Fido a totale discrezione del fornitore.

## **OFFERTE**

Le offerte sono fatte a titolo indicativo e senza impegno da parte della VALBRASS S.r.l. e si intendono scadute dopo 30 giorni dalla data di emissione. Le offerte/ordini fatte da agenti, rappresentanti ed ausiliari di commercio per conto della VALBRASS S.r.l. non sono per essa impegnative fino a quando non siano confermate dalla stessa.

Eventuali campioni verranno spediti su richiesta a carico del committente a prezzo pieno senza sconto.

## **RECLAMI e DANNI**

Prima di inoltrare reclami per merce difettosa, accertarsi che l'articolo sia effettivamente di produzione della VALBRASS S.r.l.. Tale requisito dovrà essere dimostrato con copia delle nostre fatture di vendita. Eventuali reclami riguardanti la quantità e la qualità della merce fornita devono essere inoltrati per iscritto a VALBRASS S.r.l. entro 8 giorni dal ricevimento della merce, solo tramite fax, lettera o e-mail.

Solamente in caso di messa in opera di prodotti VALBRASS S.r.l. e di danni a persone o a cose involontariamente causati da questi, verrà incaricata la nostra Compagnia Assicurativa di procedere a perizia secondo norma di polizza.

La VALBRASS S.r.l., per aprire un sinistro alla propria Assicurazione, deve ricevere tutti i danni del sinistro, fotografie degli articoli difettosi nel luogo d'installazione, uno o più campioni difettosi, i dati relativi al danneggiato, luogo dove il perito dovrà recarsi immediatamente per le perizie del caso.

Nessun rimborso sarà riconosciuto al cliente prima che la VALBRASS S.r.l. abbia verificato la causa del reclamo e/o danno. Tutto quanto possa evidenziare l'entità del danno (materiale, ecc..) deve essere tenuto a disposizione della VALBRASS S.r.l. fino a chiusura della pratica.

Il Fabbricante non può essere ritenuto responsabile di perdite, danni a persone o cose derivanti direttamente o indirettamente dall'uso improprio del prodotto.

## **GARANZIA e RESPONSABILITA'**

La nostra garanzia si limita alla riparazione o sostituzione dei pezzi riconosciuti difettosi, purché ritornati franco nostro domicilio, e non ad un indennizzo, rimborso spese o risarcimento danni. L'uso improprio dei prodotti, le modifiche, le manomissioni, l'errata installazione, le riparazioni non autorizzate, ecc..., fanno decadere il diritto di garanzia.

La VALBRASS S.r.l. declina ogni responsabilità derivanti dall'utilizzo degli apparecchi senza osservanza delle prescrizioni di sicurezza o comunque non installati correttamente, senza effettuare i controlli d'uso.



## **PREZZI**

Le quotazioni si intendono IVA esclusa e possono subire variazioni in relazione all'aumentato costo dei materiali, della manodopera, dei trasporti e spese varie (energetiche, produzione, ecc..) senza preavviso e senza obbligo di dare giustificazione dei relativi conteggi.

I prezzi possono essere modificati fino alla consegna del materiale.

## **RACCOMANDAZIONI**

Assemblare i prodotti con teflon o sigillante (non utilizzare la Canapa : il suo utilizzo fa decadere la garanzia). Visionare sempre tutti i prodotti per accertarsi del corretto assemblaggio e che gli stessi siano privi di difetti visivi. Raccomandiamo di non effettuare un'eccessiva forzatura di serraggio e accertarsi che gli O-rings non vengano lasciati esposti direttamente alla luce solare in quanto questa li deteriora.

## **MODIFICHE**

La VALBRASS S.r.l. si riserva di apportare, senza alcun preavviso, le modifiche che si rendessero commercialmente e tecnicamente necessarie.

Le caratteristiche di campioni, disegni, foto a catalogo e prezzi sul listino hanno carattere di indicazioni approssimative e non hanno valore impegnativo per la VALBRASS S.r.l..

## **OMISSIONI DI PAGAMENTI**

Eventuali reclami o contestazioni non daranno in alcun caso diritto al cliente di omettere o ritardare i pagamenti della fornitura.

## **SOSPENSIONI DI ORDINI**

Qualora sia stata constatata la difficoltà nei pagamenti da parte del Cliente, la VALBRASS S.r.l. è in facoltà di sospendere o ritardare, oltre i termini pattuiti, la consegna dei prodotti.

## **RESI**

Non si accettano merci di ritorno senza preventiva nostra autorizzazione e senza regolare documento di trasporto ed in ogni caso solo in porto franco. Il valore della merce viene declassata in funzione del tempo trascorso dalla data di consegna. La VALBRASS S.r.l. si riserva la facoltà di scegliere la percentuale di declassamento del valore del materiale reso.

## **RISERVA DI PROPRIETA'**

Tutto il materiale oggetto della fornitura è da ritenersi di proprietà della VALBRASS S.r.l. fino a totale pagamento di quanto dovuto. Il cliente, pertanto, acquista la proprietà solamente all'atto dell'integrale pagamento della fornitura, assumendosi, tuttavia, i rischi sin dal momento dell'inizio della consegna del materiale al corriere (art. 1523 c.c.).

## **COPYRIGHT**

Il logo "VB" VALBRASS è regolarmente registrato.

L'uso illecito sarà sanzionato secondo le norme di tutela del marchio.

## **FORO COMPETENTE**

Per qualsiasi vertenza e/o contestazione relativa all'applicazione del presente Contratto è competente il Foro di Brescia.

## **DICHIARAZIONE CONTRATTUALE**

Con l'accettazione delle presenti condizioni generali di vendita mediante il conferimento dell'ordine, l'acquirente rinuncia ad eventuali proprie condizioni generali di acquisto considerate singolarmente o nel loro complesso.



 **valbrass**  
*Top of the Taps!*



Valbrass srl - Via Matteotti, 311  
25063 Gardone V.T. (Brescia) - Italy  
T +39 030 8911833 - F +39 030 8912480 - [info@valbrass.com](mailto:info@valbrass.com)

[www.valbrass.com](http://www.valbrass.com)